

US00D827980S

(12) **United States Design Patent** (10) **Patent No.:** **US D827,980 S**
Slater et al. (45) **Date of Patent:** **** Sep. 11, 2018**

(54) **SWIMSUIT**

(71) Applicant: **FASTENating, LLC**, Holmdel, NJ (US)

(72) Inventors: **Jill Slater**, Morganville, NJ (US);
Alexis Castellano, Holmdel, NJ (US)

(73) Assignee: **FASTENating, LLC**, Holmdel, NJ (US)

(**) Term: **15 Years**

(21) Appl. No.: **29/615,694**

(22) Filed: **Aug. 30, 2017**

Related U.S. Application Data

(62) Division of application No. 29/530,014, filed on Jun. 12, 2015, now Pat. No. Des. 801,633.

(51) **LOC (11) Cl.** **02-02**

(52) **U.S. Cl.**
USPC **D2/731**

(58) **Field of Classification Search**
USPC D2/700, 702-706, 717, 721, 728-732,
D2/735-737, 785; 2/67; 450/1, 28, 85
CPC A41B 1/00; A41D 7/00
See application file for complete search history.

(56) **References Cited**

U.S. PATENT DOCUMENTS

599,408 A	2/1898	Uppercu
2,463,309 A	3/1949	Prince
4,447,911 A	5/1984	Marcellaro
4,457,025 A	7/1984	Meryash
4,607,369 A	8/1986	Craig
4,640,287 A	2/1987	Anderson et al.
4,835,795 A	6/1989	Lonon
5,561,858 A	10/1996	Poirier
6,016,569 A	1/2000	Everett et al.
6,035,439 A	3/2000	Chin
6,324,699 B1	12/2001	Cosmah

6,374,412 B1	4/2002	Canlas
6,434,801 B2	8/2002	Grunberger
6,964,065 B2	11/2005	Stevenson
D544,678 S	6/2007	Fitagerald
D595,480 S	7/2009	Giugliano

(Continued)

FOREIGN PATENT DOCUMENTS

WO 1995002340 1/1995

OTHER PUBLICATIONS

“Patentability Search Report”, dated Nov. 14, 2014.
(Continued)

Primary Examiner — Wan Laymon
Assistant Examiner — Clint A Samuel
(74) *Attorney, Agent, or Firm* — Bay State IP, LLC

(57) **CLAIM**

The ornamental design for a swimsuit, substantially as shown and described.

DESCRIPTION

FIG. 1 is a front, top and one side isometric view of a swimsuit showing our design;
FIG. 2 is a front, top and other side isometric view thereof;
FIG. 3 is a front elevation view thereof;
FIG. 4 is a rear elevation view thereof;
FIG. 5 is a left side elevation view thereof;
FIG. 6 is a right side elevation view thereof;
FIG. 7 is a top side elevation view thereof; and,
FIG. 8 is a bottom side elevation view thereof.
The dash-dash-dash-dash broken lines shown in the drawing views are included for the purpose of illustrating portions of the swimsuit that form no part of the claimed design. The dash-dot-dash-dot broken lines shown in the drawing views define the boundary of the claimed design.

1 Claim, 7 Drawing Sheets

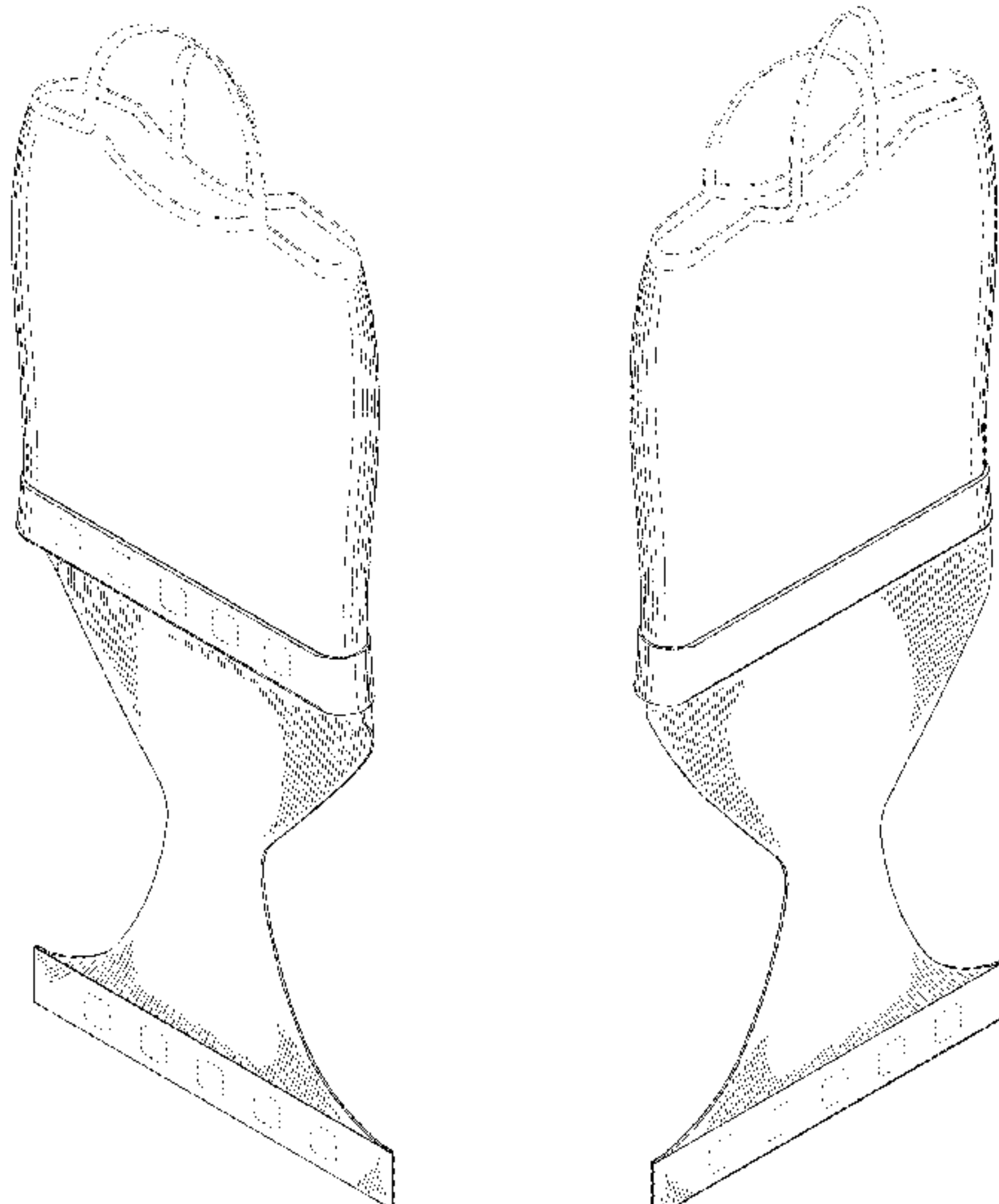

(56)

References Cited

U.S. PATENT DOCUMENTS

D600,881	S	9/2009	Naylor	
D601,326	S	10/2009	DiFrancesco	
D613,036	S	4/2010	Waldman	
D627,538	S	11/2010	Naylor	
7,908,671	B2	3/2011	Gaugler et al.	
D639,019	S	6/2011	Perryman	
8,479,320	B2	7/2013	Swafford	
D698,521	S	2/2014	Ott	
9,210,953	B2	12/2015	Horton	
D787,783	S	5/2017	Mckinney-Brown	
D801,633	S *	11/2017	Slater D2/731
2002/0062511	A1	5/2002	Lee	
2006/0166600	A1	7/2006	Ravoiiu et al.	
2008/0256676	A1	10/2008	DiLorenzo	
2012/0174283	A1	7/2012	Peters et al.	
2012/0266347	A1	10/2012	DiLorenzo	
2013/0180024	A1	7/2013	Flick	
2013/0269077	A1	10/2013	Anderson	
2014/0130228	A1	5/2014	Horton	
2014/0130231	A1	5/2014	Horton	
2014/0143985	A1	5/2014	Horton	
2016/0143373	A1 *	5/2016	Castellano A41D 11/00 2/67
2018/0084842	A1 *	3/2018	Pham Johnson A41D 7/00

OTHER PUBLICATIONS

“Office Action” issued in co-pending U.S. Appl. No. 29/530,014, dated Jan. 25, 2017.

“Office Action” issued in co-pending U.S. Appl. No. 29/530,014, dated Jun. 15, 2017.

The Underbib, <http://theunderbib.com/about-underbib-baby/>, Jun. 14, 2016.

Magnificent Baby, <http://www.magnificentbaby.com/custompages/magnificentbaby/Baby-and-Toddler-Raincoats-at-CID347.aspx>, Jun. 14, 2016.

Magnificent Baby, <http://www.magnificentbaby.com/custompages/magnificentbaby/Burrito-Bodysuits-CID264.aspx>, Jun. 14, 2016.

Magnificent Baby, <http://www.magnificentbaby.com/custompages/magnificentbaby/Footies-CID388.aspx>, Jun. 14, 2016.

Magnificent Baby, http://www.magnificentbaby.com/instructions-magnificent-baby-ccid_82.aspx, Jun. 14, 2016.

Fasten, Fasten Rainbow Hearts Swimsuit, internet posting, June. 15, 2017, 4 pp., <http://www.fastenswim.com/products/rainbow-hearts-swimsuit>.

The Underbib, <http://theunderbib.com/product-category/underbib-baby/>, Jun. 14, 2016.

“Notice of Allowance” issued in co-pending U.S. Appl. No. 29/530,014, dated Aug. 17, 2017.

* cited by examiner

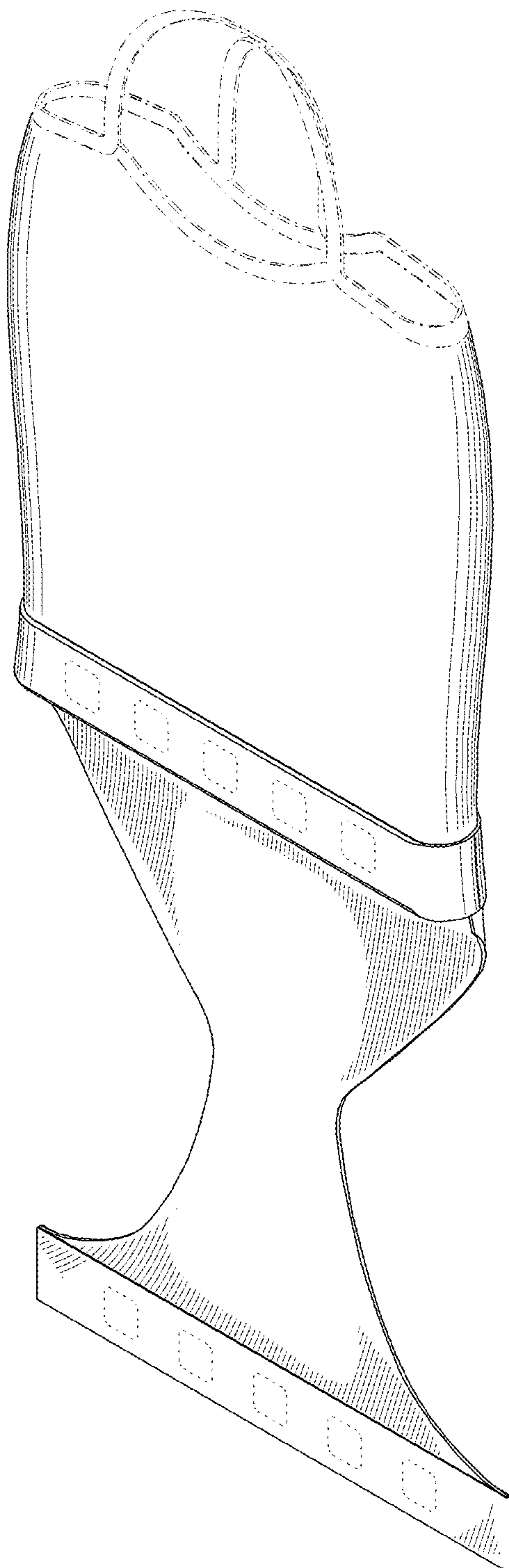

FIG. 1

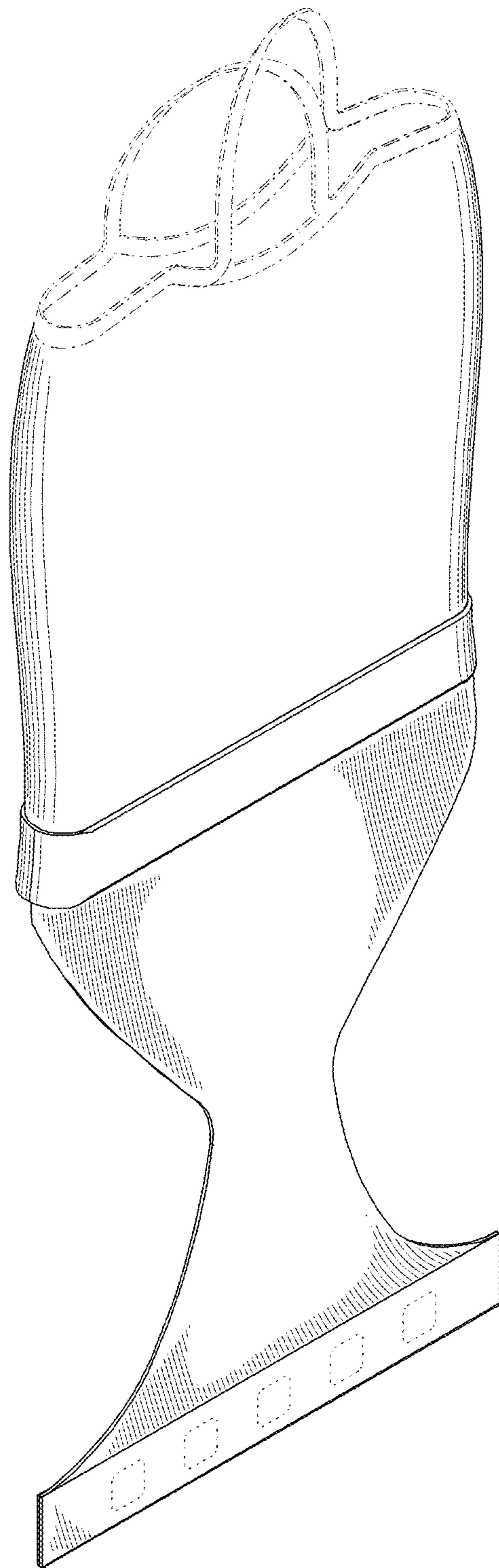

FIG. 2

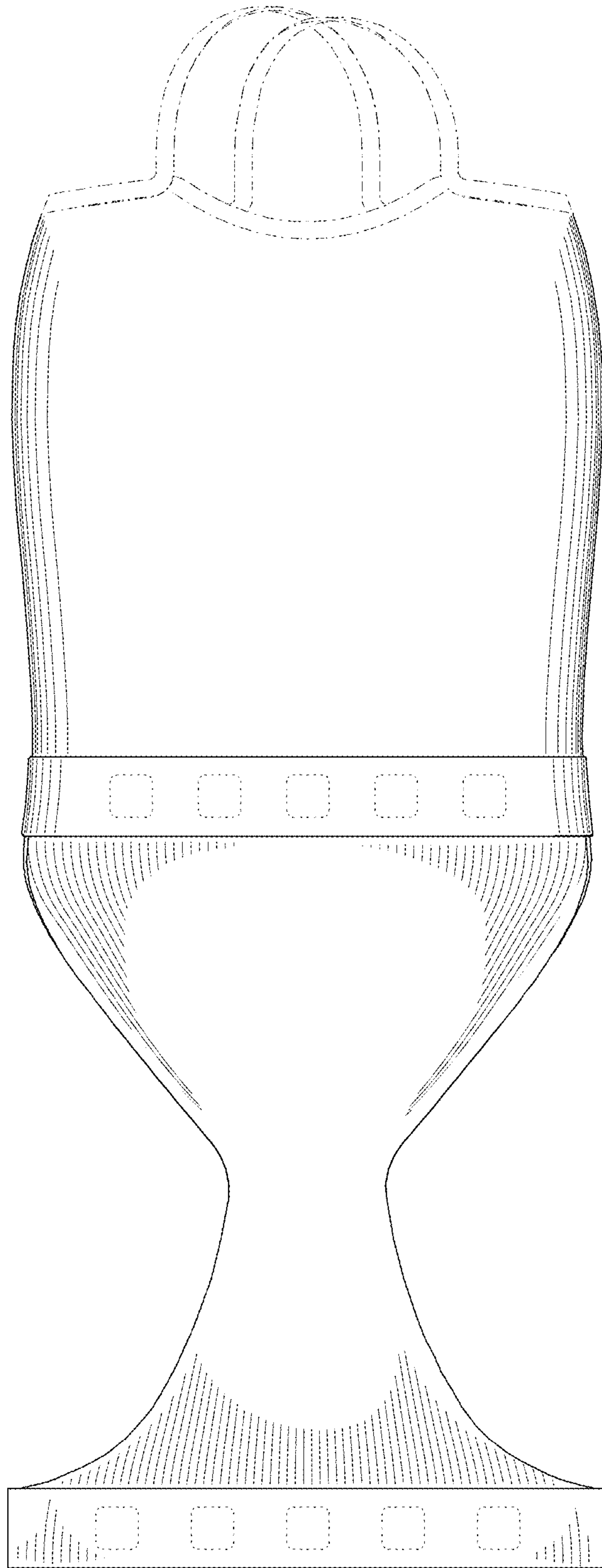

FIG. 3

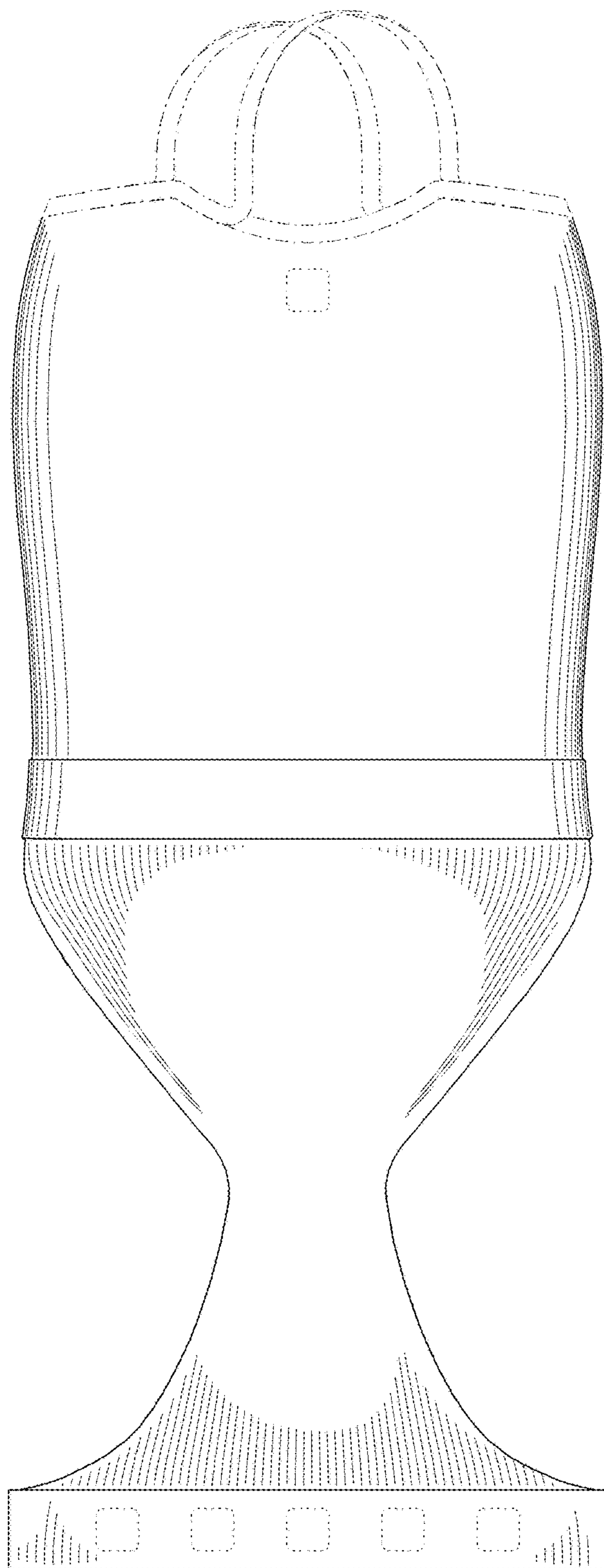

FIG. 4

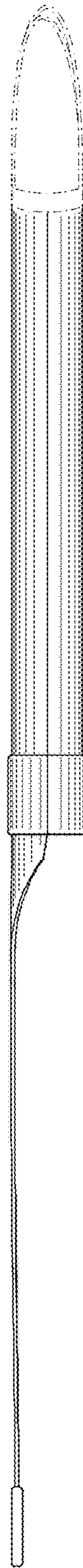

FIG. 5

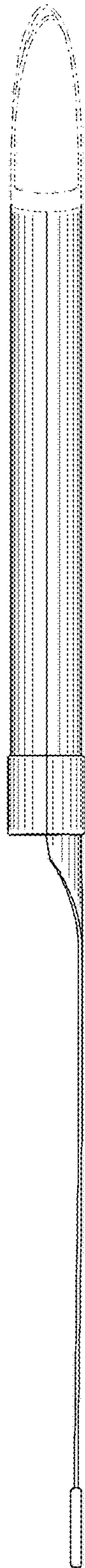

FIG. 6

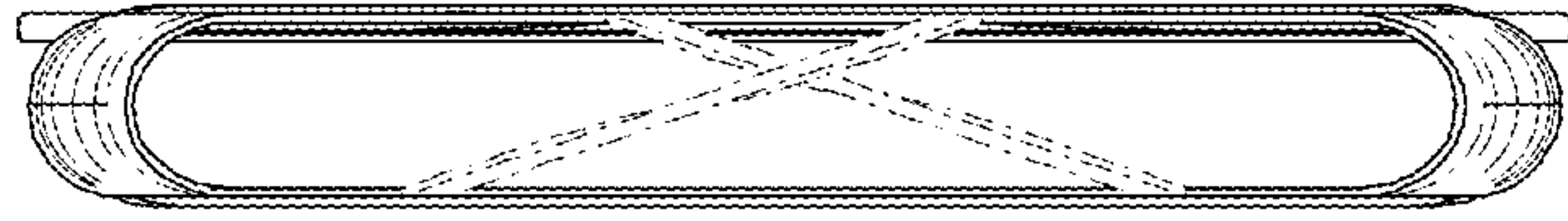

FIG. 7

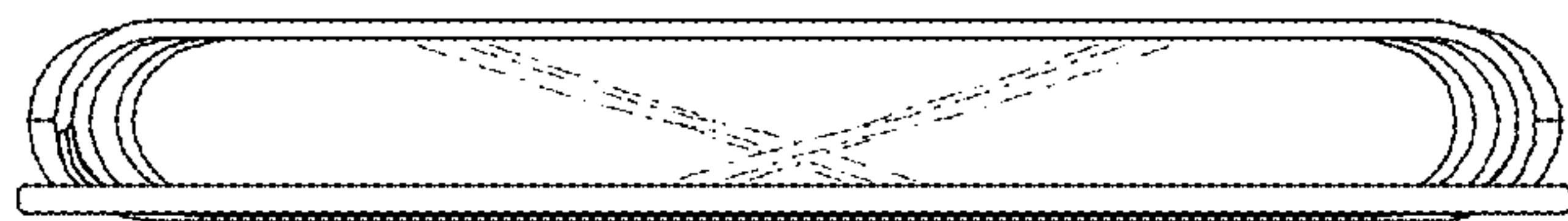

FIG. 8