



US00D827957S

(12) **United States Design Patent** (10) **Patent No.:** **US D827,957 S**  
**Lee** (45) **Date of Patent:** **\*\* Sep. 4, 2018**

(54) **DOOR FOR WASHING MACHINE**

(71) Applicant: **LG ELECTRONICS INC., Seoul (KR)**

(72) Inventor: **Yongsok Lee, Seoul (KR)**

(73) Assignee: **LG ELECTRONICS INC., Seoul (KR)**

(\*\*) Term: **15 Years**

(21) Appl. No.: **35/501,991**

(22) Filed: **May 30, 2016**

(80) **Hague Agreement Data**

Int. Filing Date: **May 30, 2016**

Int. Reg. No.: **DM/091079**

Int. Reg. Date: **May 30, 2016**

Int. Reg. Pub. Date: **Dec. 2, 2016**

(30) **Foreign Application Priority Data**

Nov. 30, 2015 (KR) ..... 30-2015-0060416

(51) **LOC (11) Cl.** ..... **15-05**

(52) **U.S. Cl.**  
USPC ..... **D32/25**

(58) **Field of Classification Search**

USPC ..... D32/1, 5, 6, 8, 10, 25, 28  
CPC ..... D06F 3/02; D06F 2204/065; D06F 25/00;  
D06F 35/006; D06F 37/28; D06F 39/14;  
D06F 58/00; D06F 58/02; D06F 58/04;  
D06F 58/20; D06F 23/04; G05B 19/042

See application file for complete search history.

(56) **References Cited**

**U.S. PATENT DOCUMENTS**

D428,222 S \* 7/2000 Tunzi ..... D32/25  
D434,536 S \* 11/2000 Schober ..... D32/25  
D617,512 S \* 6/2010 DeSalvo ..... D32/25

D618,871 S \* 6/2010 DeSalvo ..... D32/25  
D620,212 S \* 7/2010 Bixby ..... D32/25  
D646,859 S \* 10/2011 DeSalvo ..... D32/25  
D648,909 S \* 11/2011 Bhattacharya ..... D32/25  
D651,778 S \* 1/2012 Miller ..... D32/25  
D699,906 S \* 2/2014 Choi ..... D32/25  
D714,502 S \* 9/2014 Jeon ..... D32/25  
D746,006 S \* 12/2015 Ha ..... D32/25  
D755,457 S \* 5/2016 Chung ..... D32/25  
D758,028 S \* 5/2016 Bixby ..... D32/25  
D758,032 S \* 5/2016 Bixby ..... D32/25  
D759,326 S \* 6/2016 Jeon ..... D32/25  
D759,915 S \* 6/2016 Choi ..... D32/25  
D760,456 S \* 6/2016 Jeon ..... D32/25  
D761,506 S \* 7/2016 Choi ..... D32/25  
D767,835 S \* 9/2016 Ha ..... D32/25  
D772,507 S \* 11/2016 Bixby ..... D32/25  
2003/0046964 A1 \* 3/2003 Bollmann ..... D06F 37/28  
68/139

\* cited by examiner

*Primary Examiner* — Darlington Ly

(74) *Attorney, Agent, or Firm* — Birch, Stewart, Kolasch & Birch, LLP

(57) **CLAIM**

The ornamental design for a door for washing machine, as shown and described.

**DESCRIPTION**

1. Door for washing machine

1.1 is a top, front, and left side perspective view of a door for washing machine showing my new design;

1.2 is a front elevation view thereof;

1.3 is a rear elevation view thereof;

1.4 is a left side elevation view thereof;

1.5 is a right side elevation view thereof;

1.6 is a top plan view thereof; and

1.7 is a bottom plan view thereof.

The broken lines in the reproductions illustrate portions of the door for washing machine that form no part of the claimed design.

**1 Claim, 7 Drawing Sheets**

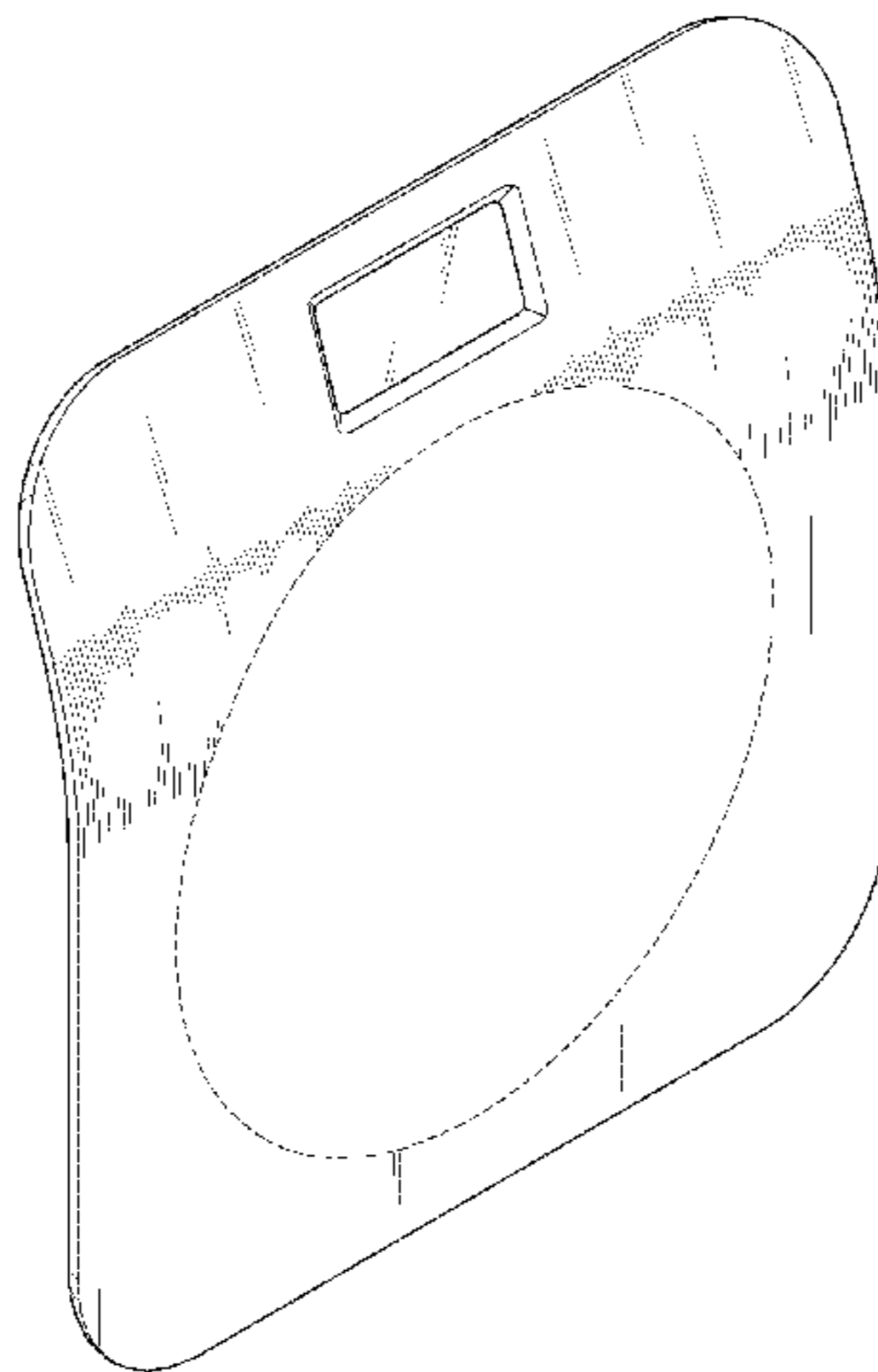

1.1

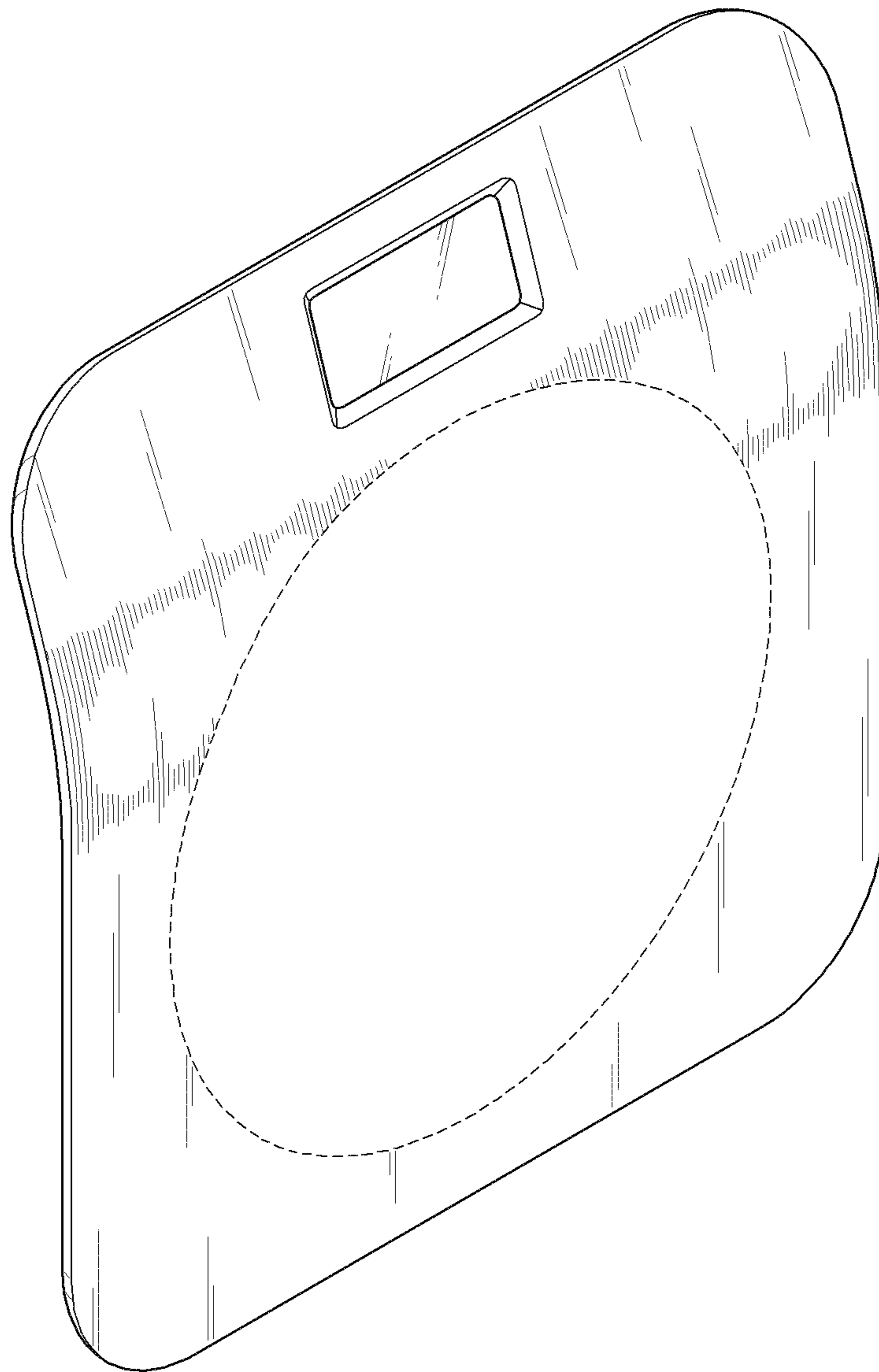

1.2

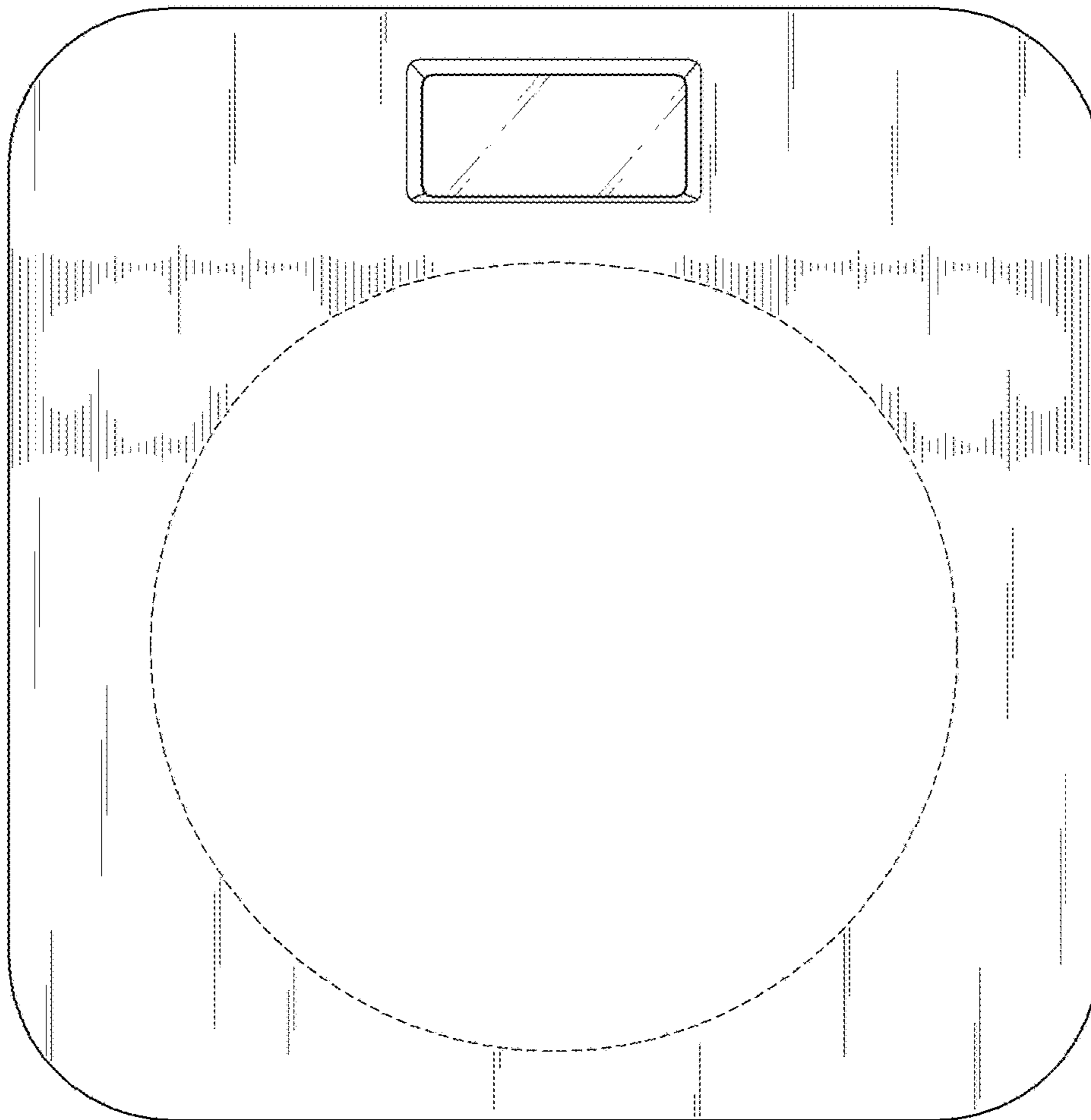

1.3

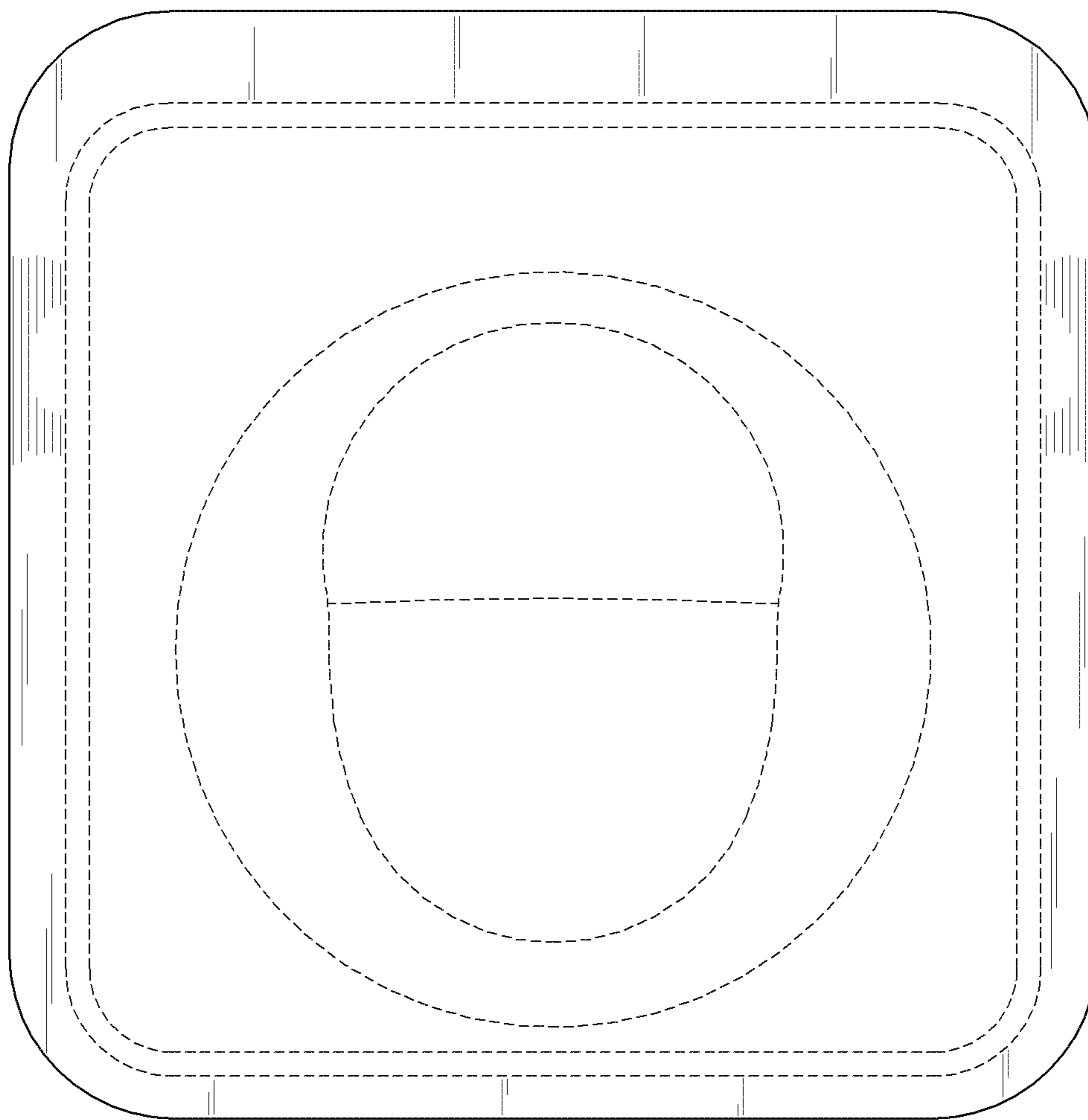

1.4

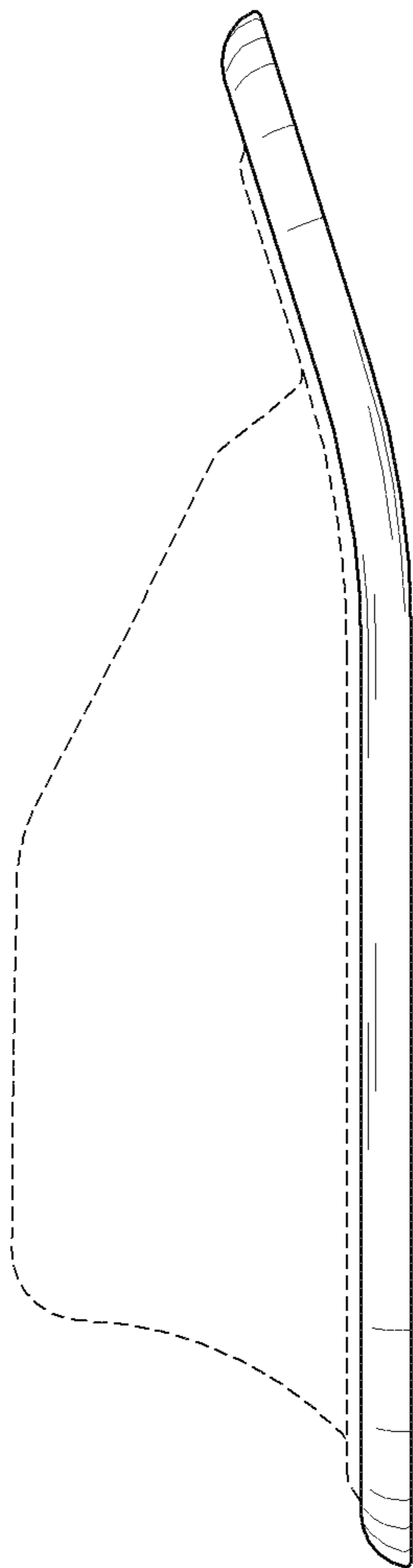

1.5

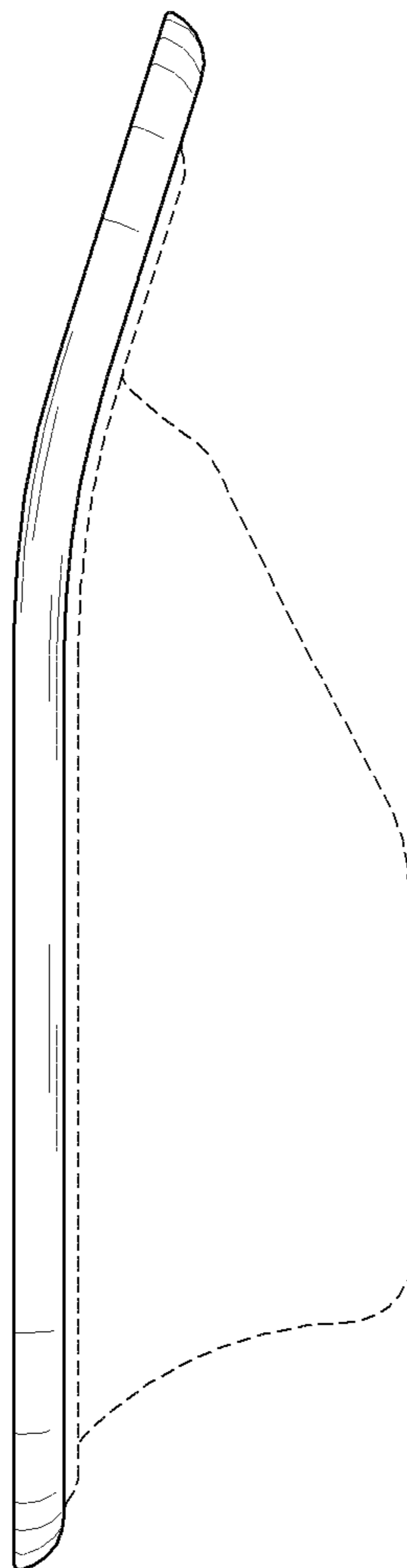

1.6

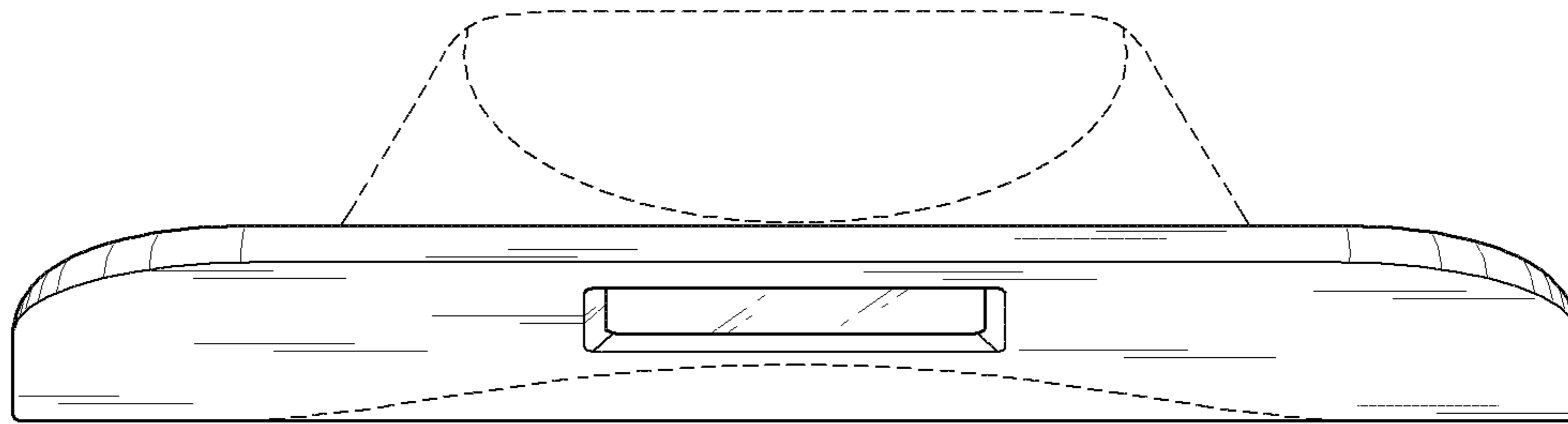

1.7

