



US00D827924S

(12) **United States Design Patent** (10) **Patent No.:** **US D827,924 S**
Crane et al. (45) **Date of Patent:** **** Sep. 4, 2018**

(54) **MAKEUP APPLICATOR**

(71) Applicant: **L'OREAL**, Paris (FR)
 (72) Inventors: **Christine Marie Crane**, Watchung, NJ (US); **Mikhail Motornov**, Clark, NJ (US); **Gracemarie Rose Papaleo-Trombetta**, Staten Island, NY (US); **Ludovic LeCaro**, Morristown, NJ (US); **Noemie Chaillet Piquand**, Paris (FR); **Balanda Atis**, Newark, NJ (US); **Anke Hadasch**, Jersey-City, NJ (US)

(73) Assignee: **L'OREAL**, Paris (FR)

(**) Term: **15 Years**

(21) Appl. No.: **29/557,530**

(22) Filed: **Mar. 9, 2016**

(51) **LOC (11) Cl.** **28-02**

(52) **U.S. Cl.**
USPC **D28/7**

(58) **Field of Classification Search**

USPC D28/7, 44, 46, 50, 52, 55-57, 99, 76-77, D28/82, 85, 68; D24/170, 176, 232, 181; D4/116, 118-119, 122, 127, 132, 135; D19/108, 125, 123, 159, 115, 158, 163; D21/181; D30/162; D3/7, 9; D8/72, 73
 CPC A45D 34/041; A45D 2/22; A45D 2/2471; A45D 26/0066; A45D 26/0071; A45D 29/004; A45D 29/007; A45D 29/04; A45D 34/045; A45D 34/042; A45D 34/04; A45D 33/36; A45D 33/12; A45D 29/16; A45D 29/12; A45D 34/06; A45D 40/00; A45D 33/00; A45D 40/02; A45D 40/065; A45D 40/20; A45D 40/205; A45D 40/06; A45D 40/16; A45D 40/28; A61K 8/02; A61K 9/00; A61B 17/24

See application file for complete search history.

(56) **References Cited**

U.S. PATENT DOCUMENTS

1,636,148 A * 7/1927 Provost A45D 29/16
132/74.5
2,374,065 A * 4/1945 Worthington A45D 40/06
132/320
D149,899 S * 6/1948 Melnikoff D28/7
2,892,202 A * 6/1959 Williams A45D 34/041
401/208
4,630,954 A * 12/1986 Ladd, Jr. A46B 7/02
132/298
D307,191 S * 4/1990 Blutenthal D28/7
4,998,838 A * 3/1991 Cancelosa A45D 34/04
401/202
D330,608 S * 10/1992 Lunderman D28/57
D334,248 S * 3/1993 Odabach D28/57
D338,739 S * 8/1993 Odabach D28/57
D366,151 S * 1/1996 Norris D4/114

(Continued)

Primary Examiner — Ian Simmons

Assistant Examiner — Shannon W Morgan

(74) *Attorney, Agent, or Firm* — Oblon, McClelland, Maier & Neustadt, L.L.P.

(57) **CLAIM**

The ornamental sign for a makeup applicator, as shown and described.

DESCRIPTION

FIG. 1 is a front, top, and right side perspective view of a makeup applicator;
 FIG. 2 is a front, bottom, and right side perspective view of thereof;
 FIG. 3 is a bottom plan view thereof;
 FIG. 4 is a top plan view thereof;
 FIG. 5 is a left side elevational view thereof;
 FIG. 6 is a right side elevational view thereof;
 FIG. 7 is a front elevational view thereof; and,
 FIG. 8 is a rear elevational view thereof.
 The broken lines in the figures depict portions of the makeup applicator that form no part of the claimed design.

1 Claim, 5 Drawing Sheets

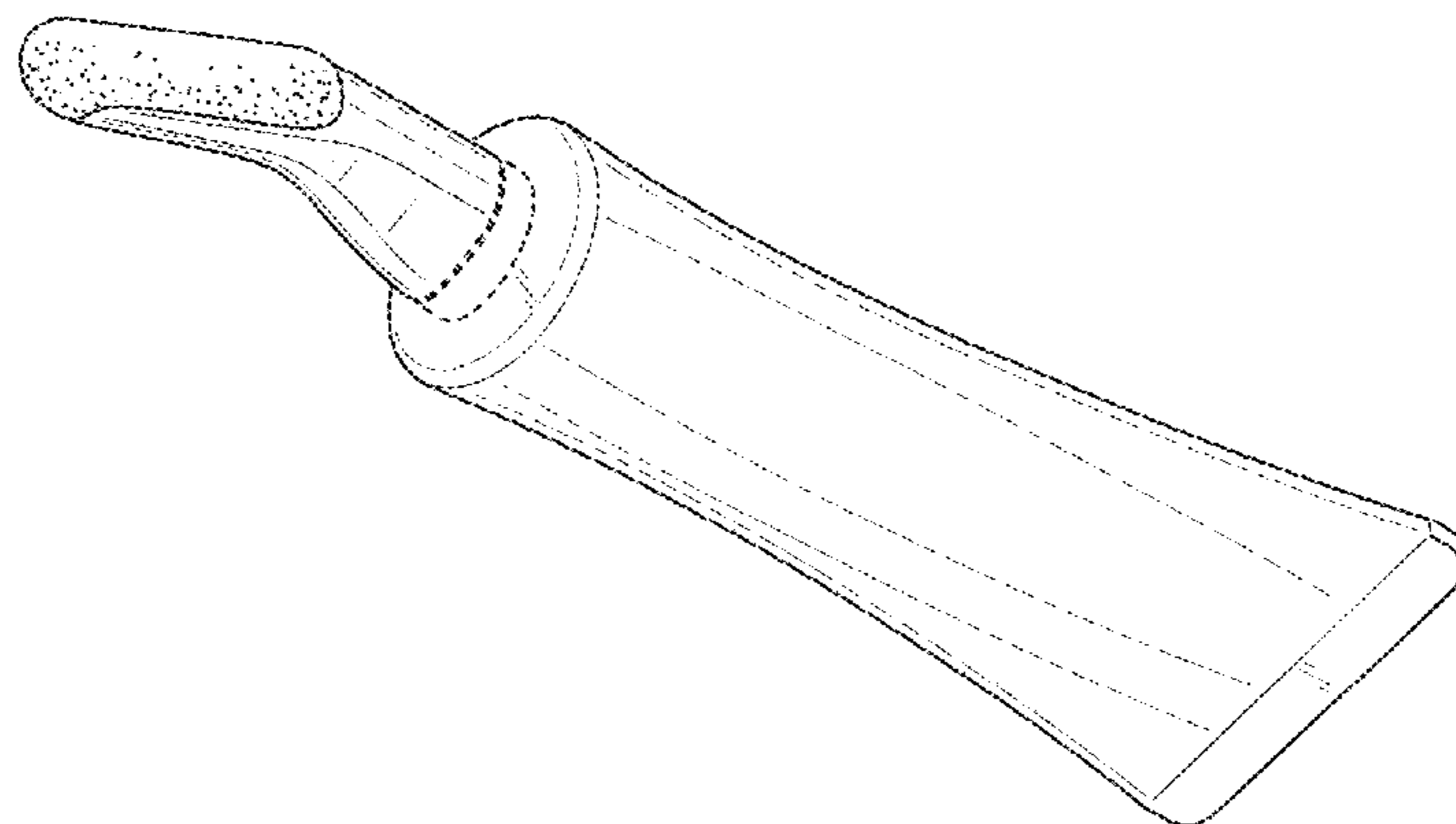

(56)

References Cited

U.S. PATENT DOCUMENTS

D370,087	S *	5/1996	Baltierra	D28/57
D371,221	S *	6/1996	Attaway	D28/46
D394,128	S *	5/1998	Atkinson	D28/57
D416,688	S *	11/1999	Baltierra	D28/57
D560,035	S *	1/2008	Ross	D28/57
D561,046	S *	2/2008	Kerman	D9/697
D570,708	S *	6/2008	Kerman	D9/697
D588,749	S *	3/2009	Wittke-Kothe	D24/149
D658,504	S *	5/2012	McCoy	D9/697
D776,342	S *	1/2017	Otani	D28/7
2005/0217685	A1 *	10/2005	Burkholz	A45D 29/17 132/74.5
2008/0286034	A1 *	11/2008	Chu	A45D 34/04 401/266
2008/0314405	A1 *	12/2008	Chu	A45D 34/04 132/320
2011/0082432	A1 *	4/2011	Fontana	A45D 34/04 604/310

* cited by examiner

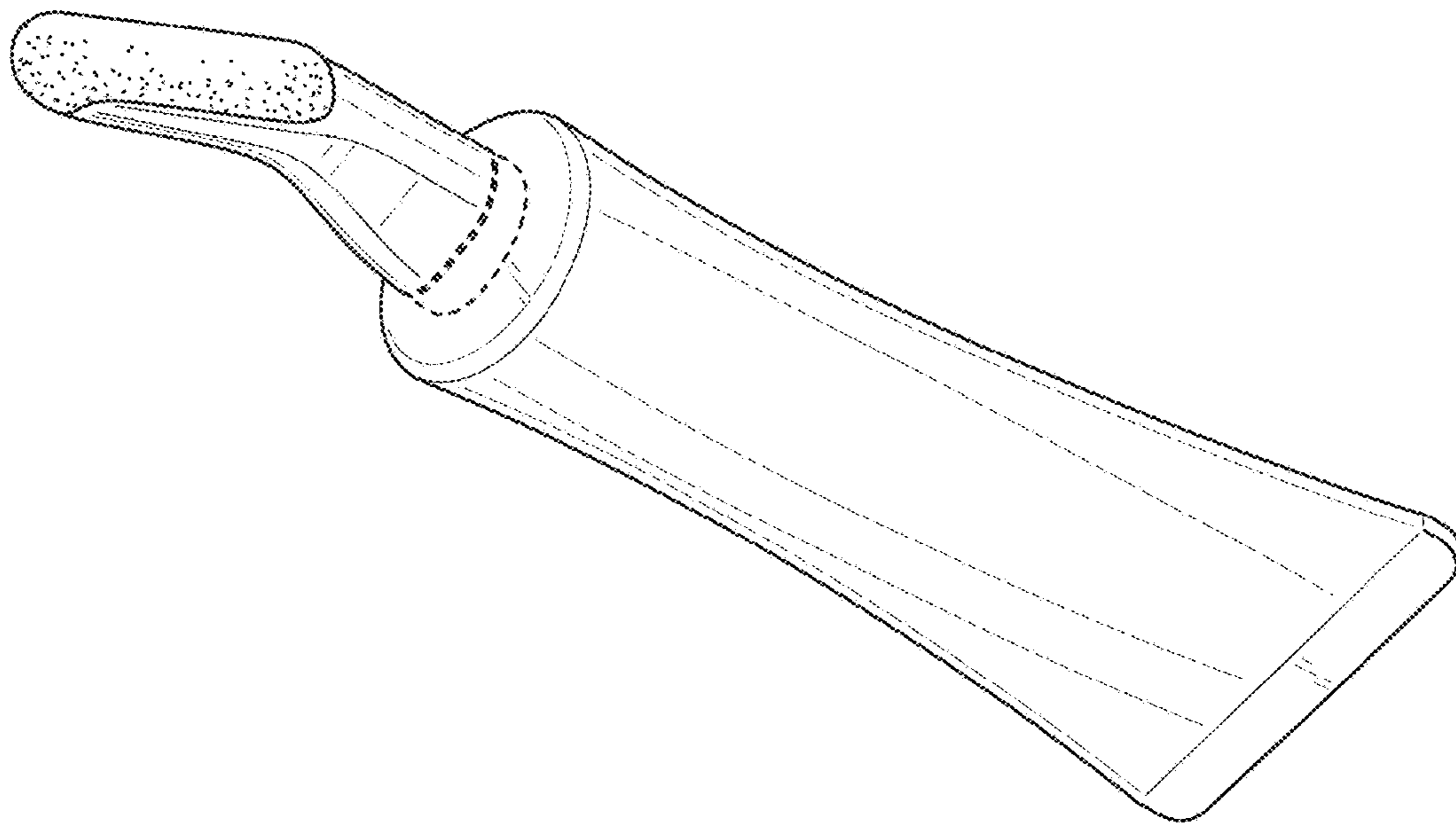

FIG. 1

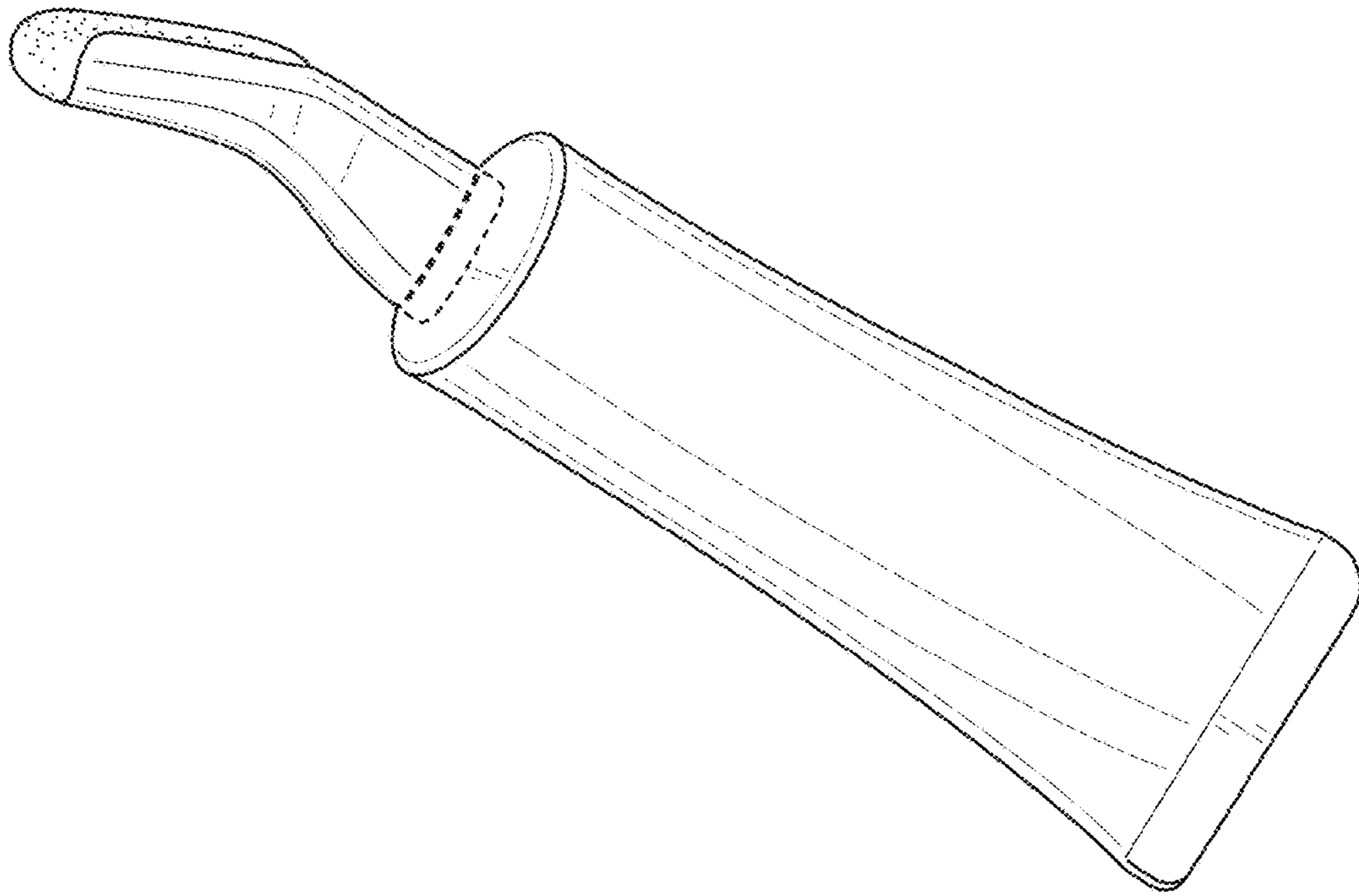

FIG. 2

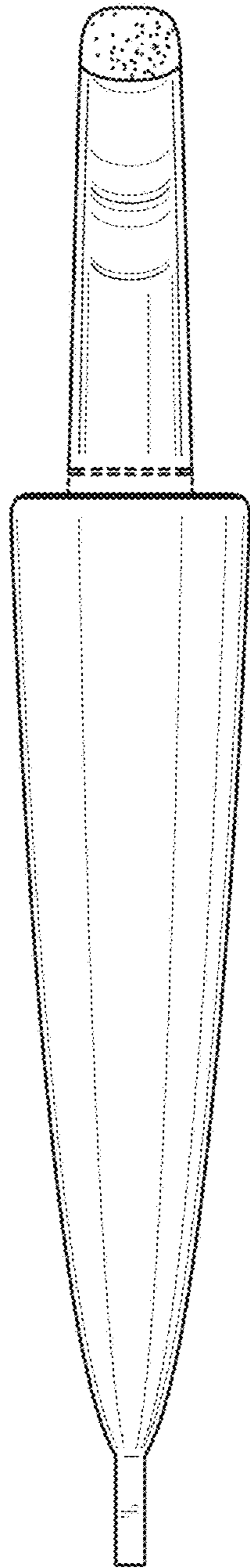

FIG. 3

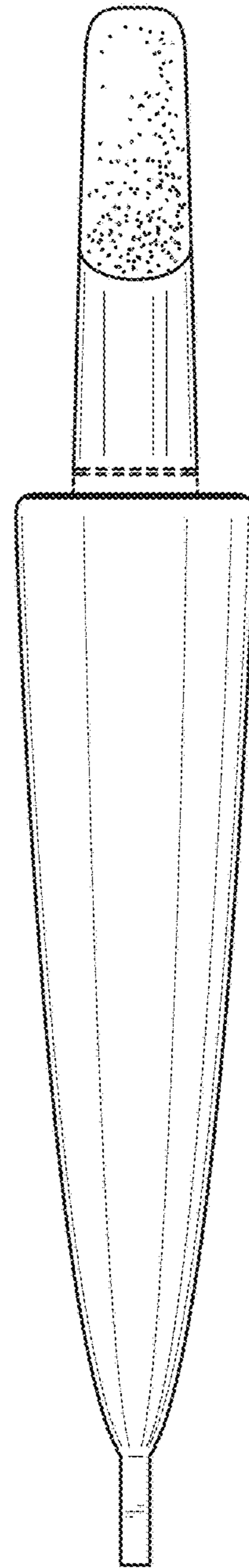

FIG. 4

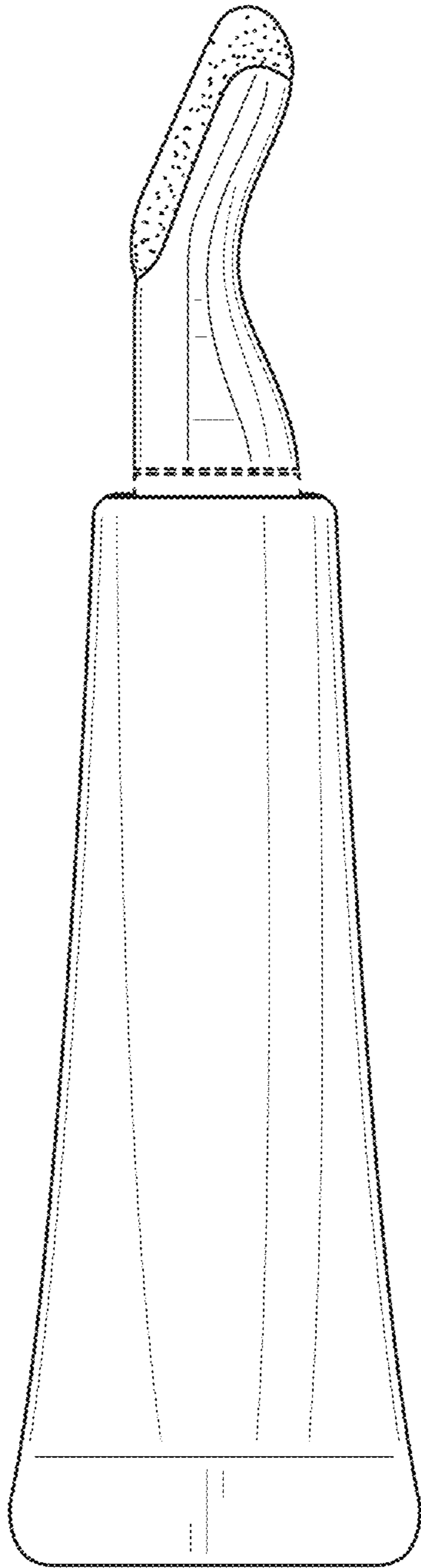

FIG. 5

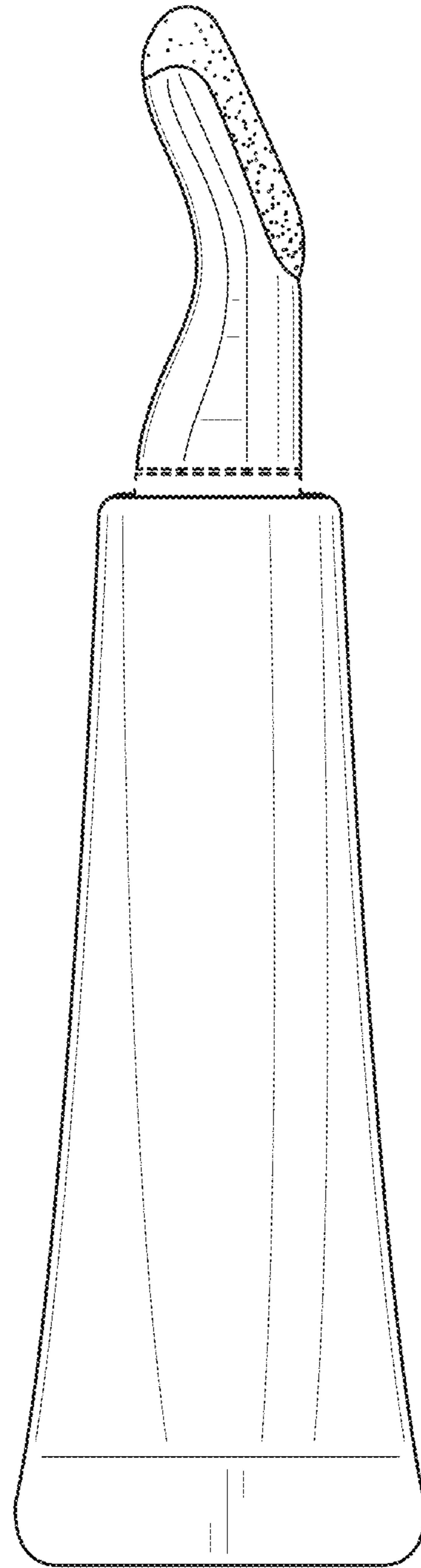

FIG. 6

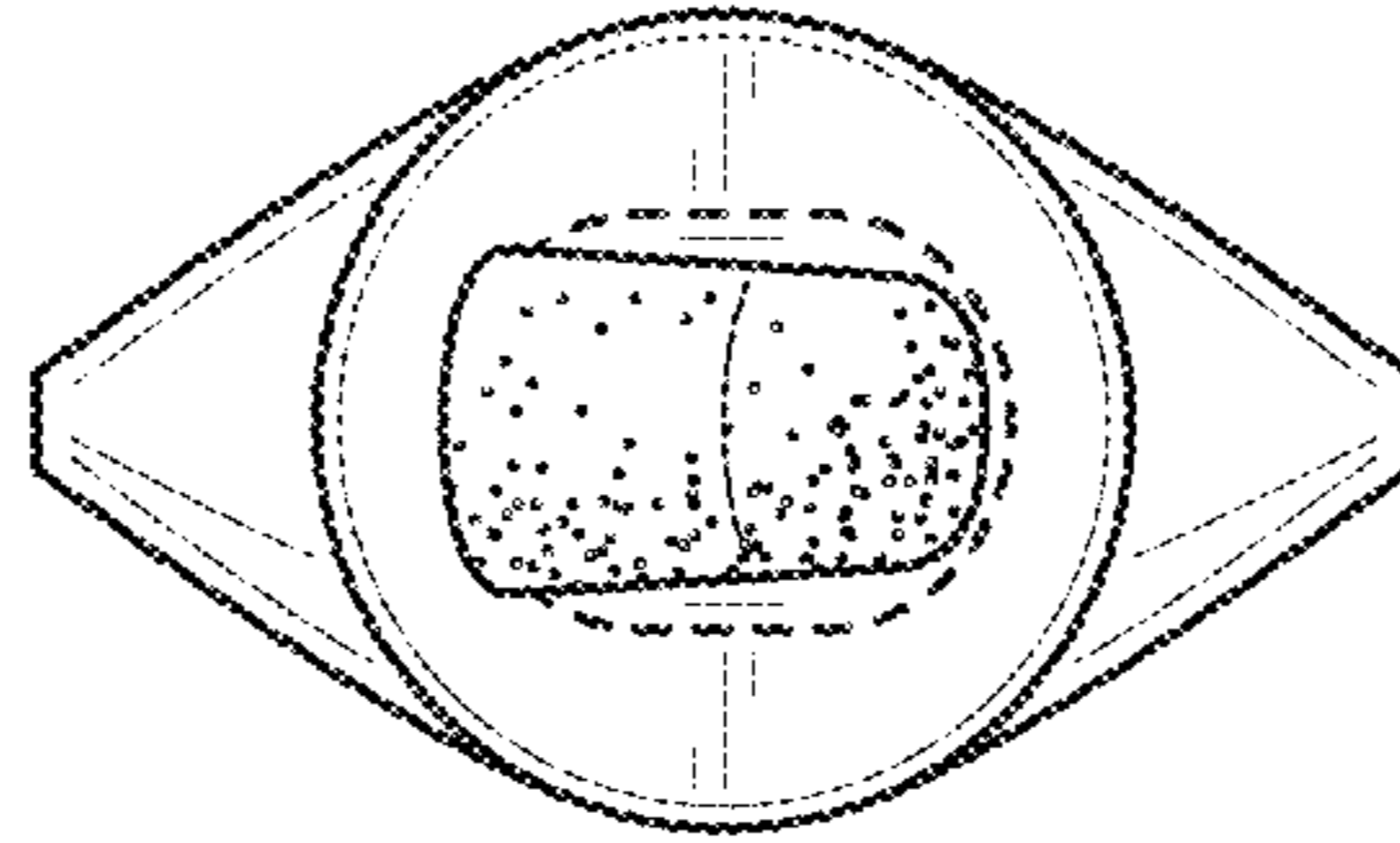

FIG. 7

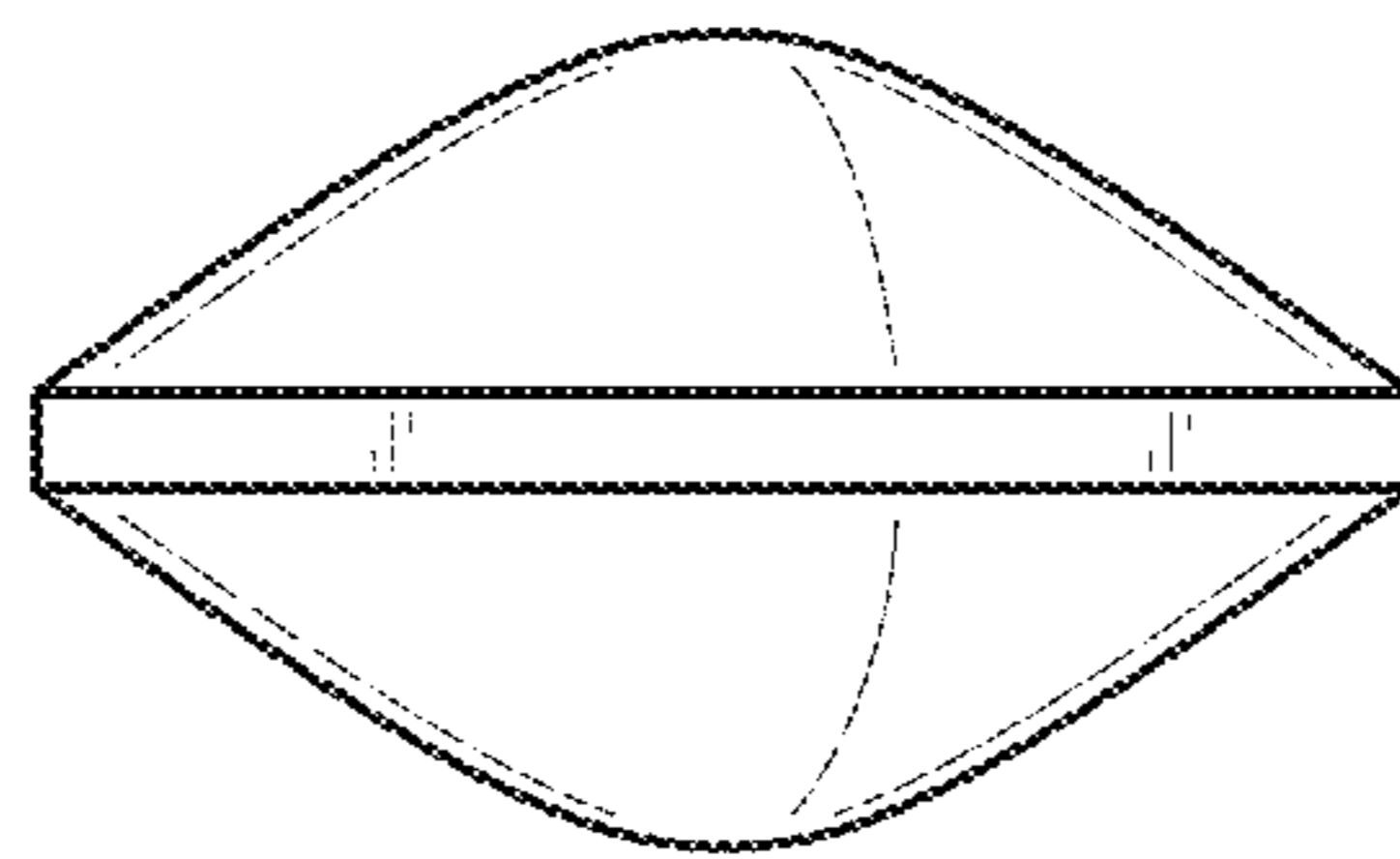

FIG. 8

UNITED STATES PATENT AND TRADEMARK OFFICE
CERTIFICATE OF CORRECTION

PATENT NO. : D827,924 S
APPLICATION NO. : 29/557530
DATED : September 4, 2018
INVENTOR(S) : Christine Marie Crane et al.

Page 1 of 1

It is certified that error appears in the above-identified patent and that said Letters Patent is hereby corrected as shown below:

On the Title Page

In Column 2, item (57), CLAIM, Line 1, delete "sign" and insert --design--.

Signed and Sealed this
Nineteenth Day of November, 2019

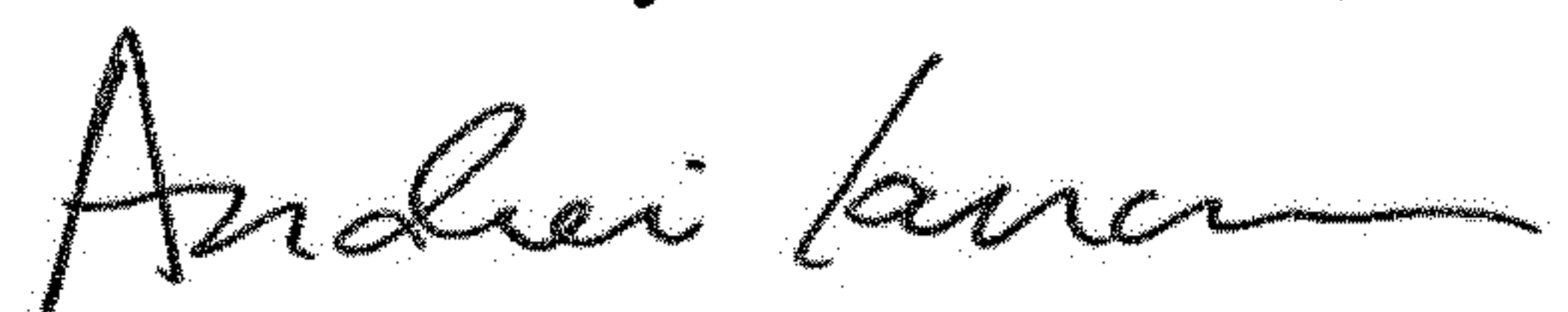

Andrei Iancu
Director of the United States Patent and Trademark Office