



US00D827872S

(12) **United States Design Patent**
Amrine et al.

(10) **Patent No.:** **US D827,872 S**

(45) **Date of Patent:** **** Sep. 4, 2018**

(54) **PAVER AND LANDSCAPE EDGING**

2,877,600 A 3/1959 Slate
D185,236 S 5/1959 Reese
3,170,201 A 2/1965 Nofziger

(Continued)

(71) Applicant: **Dimex, LLC**, Marietta, OH (US)

(72) Inventors: **Patrick Amrine**, Williamstown, WV (US); **Forrest Adam Sanders**, Marietta, OH (US)

FOREIGN PATENT DOCUMENTS

GB 480927 A 3/1938
GB 2369979 A 6/2002

(Continued)

(73) Assignee: **Dimex, LLC**, Marietta, OH (US)

(**) Term: **15 Years**

OTHER PUBLICATIONS

(21) Appl. No.: **29/608,189**

Dimex EdgePro Website. <http://www.edgepro.com/hardscape/edgepro-h.sub.-edge.html> Found Jul. 15, 2016.

(Continued)

(22) Filed: **Jun. 20, 2017**

(51) **LOC (11) Cl.** **25-01**

(52) **U.S. Cl.**

USPC **D25/164**; D25/119

(58) **Field of Classification Search**

USPC D25/119, 164, 35, 58, 113, 114, 115, D25/139, 199

CPC A01G 1/08; A01G 1/00; E01C 11/221; E01C 11/222; E01C 11/223; E01C 11/225

See application file for complete search history.

Primary Examiner — Mark A Goodwin

(74) *Attorney, Agent, or Firm* — Wood Herron & Evans LLP

(57)

CLAIM

An ornamental design for a paver and landscape edging, as shown and described.

DESCRIPTION

FIG. 1 is a front isometric view of a paver and landscape edging showing our new design; FIG. 2 is a top plan view thereof; FIG. 3 is a bottom plan view thereof; FIG. 4 is a front elevation view thereof; FIG. 5 is a rear elevation view thereof; FIG. 6 is right side elevation view thereof; FIG. 7 is a left side elevation view thereof; and, FIG. 8 is a top plan view thereof.

The portion that is broken and bracketed is intended to designate indeterminate length. The broken dash lines and hatching denote unclaimed portions of the invention. Neither the broken dash line portions nor the broken dash lines themselves form any part of the claimed invention.

1 Claim, 4 Drawing Sheets

(56) **References Cited**

U.S. PATENT DOCUMENTS

268,441 A	12/1882	Tunica
457,886 A	8/1891	Landis
992,529 A	5/1911	Abraham
1,666,613 A	4/1928	Woods
1,843,108 A	2/1932	Clayden
1,997,876 A	4/1935	Sheldon
2,163,613 A	6/1939	Manofsky
2,164,681 A	7/1939	Fould
2,193,425 A	3/1940	Lake
D130,420 S	11/1941	Schlatter
D151,022 S	9/1948	Weber et al.
D178,659 S	9/1956	Hield
2,809,809 A	10/1957	Johnston

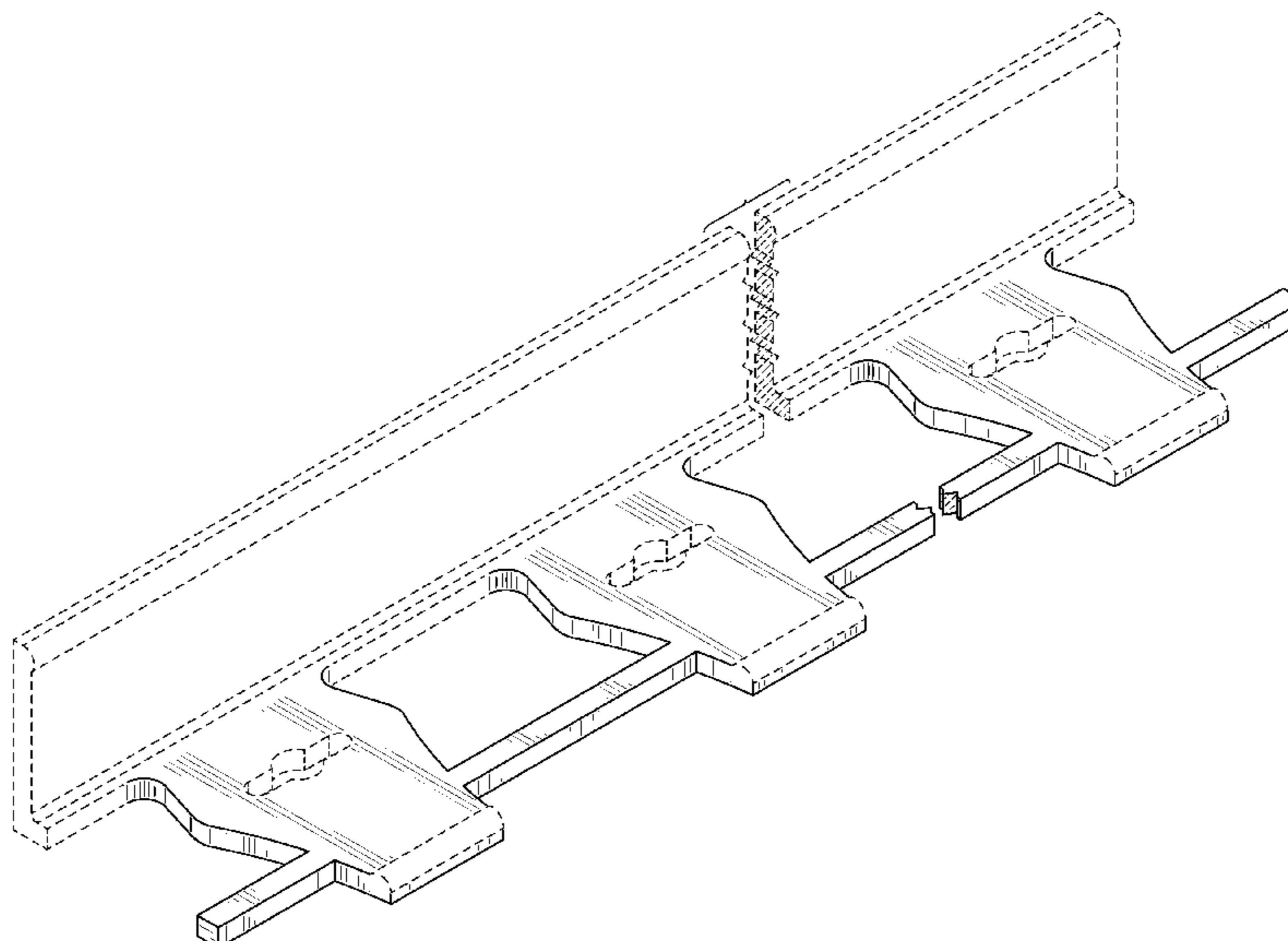

(56)

References Cited

U.S. PATENT DOCUMENTS

3,222,841 A 12/1965 Lipof
 3,314,193 A 4/1967 Chancellor
 3,332,197 A 7/1967 Hinkle
 3,378,949 A 4/1968 Dorris
 3,484,989 A 12/1969 Lazinsky
 3,520,082 A 7/1970 Smith
 3,604,164 A 9/1971 Mason
 3,619,944 A 11/1971 Matvey
 3,728,837 A 4/1973 Kiefer, Jr.
 3,788,001 A 1/1974 Balfanz, Jr.
 3,815,311 A 6/1974 Nisula et al.
 3,957,383 A 5/1976 Fredericks
 4,182,072 A 1/1980 Much
 4,202,145 A 5/1980 Coulter et al.
 D257,064 S 9/1980 Kobee
 4,349,596 A 9/1982 Hendrix
 4,628,632 A 12/1986 Zwier
 4,744,194 A 5/1988 Yasuyoshi
 4,761,923 A 8/1988 Reum et al.
 4,809,459 A 3/1989 Brylla et al.
 4,824,068 A 4/1989 Ferland
 4,858,379 A 8/1989 West
 4,863,307 A 9/1989 Jones
 4,905,442 A 3/1990 Daniels
 4,907,783 A 3/1990 Fisk et al.
 4,987,717 A 1/1991 Dameron, Jr.
 5,020,272 A 6/1991 Herrema et al.
 5,048,241 A 9/1991 Gavin, Jr.
 5,117,583 A 6/1992 Reum
 D329,707 S 9/1992 Embree et al.
 D329,709 S 9/1992 Strobl, Jr.
 5,152,507 A 10/1992 Lee
 5,157,867 A 10/1992 Fritch
 5,212,917 A 5/1993 Kurtz et al.
 5,240,343 A 8/1993 Strobl, Jr.
 D339,199 S 9/1993 Rynberk
 5,301,461 A 4/1994 Zwier
 5,375,941 A 12/1994 Strobl, Jr.
 5,379,546 A 1/1995 Popp
 5,421,118 A 6/1995 Bauer
 5,442,877 A 8/1995 Lindhal
 D363,788 S 10/1995 Caley
 D366,191 S 1/1996 Gay
 5,501,036 A 3/1996 Torp, Jr. et al.
 D368,969 S 4/1996 Davies
 D372,547 S 8/1996 Sjodin
 D373,205 S 8/1996 Caley
 5,544,445 A 8/1996 Mantilla
 D378,857 S 4/1997 Hale
 5,640,801 A 6/1997 Rynberk
 D393,164 S 4/1998 Russell et al.
 5,771,643 A 6/1998 Parker
 5,772,357 A 6/1998 Evans
 D400,985 S 11/1998 Risi
 D408,558 S 4/1999 Levy
 D413,397 S 8/1999 Benjamin
 5,930,947 A 8/1999 Eckhoff
 5,941,018 A 8/1999 Herrema
 6,012,254 A 1/2000 Gaston
 6,030,144 A 2/2000 Cannella
 6,038,811 A 3/2000 Conway
 D424,714 S 5/2000 Hale
 6,085,458 A 7/2000 Gau
 6,099,201 A 8/2000 Abbrancati
 6,108,969 A 8/2000 Danna et al.
 D433,291 S 11/2000 Shamoon

6,226,934 B1 5/2001 Gaston
 6,324,782 B1 12/2001 Gaston
 6,324,783 B1 12/2001 McIntyre et al.
 D453,578 S 2/2002 Olson
 6,345,465 B1 2/2002 Allen et al.
 6,379,078 B1 4/2002 Zwier
 D462,788 S 9/2002 Thornton et al.
 D463,581 S 9/2002 Mann
 D463,582 S 9/2002 Conde
 6,449,897 B1 9/2002 Gaston
 6,485,226 B1 11/2002 Harger
 D467,015 S 12/2002 O'Brien
 6,568,126 B2 5/2003 Womack
 6,619,565 B1 9/2003 Abbott
 6,629,383 B2 10/2003 Allen et al.
 D489,465 S 5/2004 Allsopp
 6,754,989 B2 6/2004 Eicher
 6,779,297 B2 8/2004 Conde
 7,051,477 B2 5/2006 Burnham
 D541,952 S 5/2007 Keeley et al.
 D543,286 S 5/2007 Keeley et al.
 D548,368 S 8/2007 Hale et al.
 D586,005 S 2/2009 Schumaker et al.
 D586,926 S * 2/2009 Orton D25/119
 D595,429 S * 6/2009 Orton D25/119
 D600,822 S * 9/2009 Coleman, Jr. D25/113
 D606,670 S 12/2009 Keeley
 D612,072 S 3/2010 Keeley
 D617,009 S * 6/2010 Lemings D25/102
 D733,936 S 7/2015 Amrine et al.
 9,109,337 B2 * 8/2015 Wink E01C 11/222
 9,206,561 B2 * 12/2015 Alfieri, III E01C 11/221
 D748,822 S 2/2016 Amrine et al.
 D748,823 S 2/2016 Amrine et al.
 D773,074 S 11/2016 Amrine et al.
 D776,834 S 1/2017 Amrine et al.
 D797,320 S * 9/2017 Amrine D25/164
 D800,352 S * 10/2017 Amrine D25/164
 2002/0139045 A1 10/2002 Womack
 2003/0188478 A1 10/2003 Womack
 2008/0163566 A1 * 7/2008 Bella A01G 9/28
 52/102
 2011/0173901 A1 * 7/2011 Runkles E01C 11/221
 52/102
 2011/0277395 A1 * 11/2011 Wink E01C 11/222
 52/102
 2015/0252536 A1 * 9/2015 Alfieri, III E01C 11/221
 404/7
 2016/0222601 A1 * 8/2016 Alfieri, III A01G 9/28

FOREIGN PATENT DOCUMENTS

JP 7255277 10/1995
 JP 2002253060 A 9/2002
 JP 3490497 B2 1/2004

OTHER PUBLICATIONS

Valley View Industries Website. Diamond-LoK paver edgings.
<http://www.valleyviewind.com/consumers/paver-edgings/diamond-paver-edge/> Copyright 2016. Found Jul. 15, 2016.
 Valley View Specialties Co., Diamond-Lok Paver/Briick Edging,
 Pre Apr. 1996.
 Permaloc, Structure Edge Interlocking Snap-down Splicing System,
 Pre Apr. 1996.

* cited by examiner

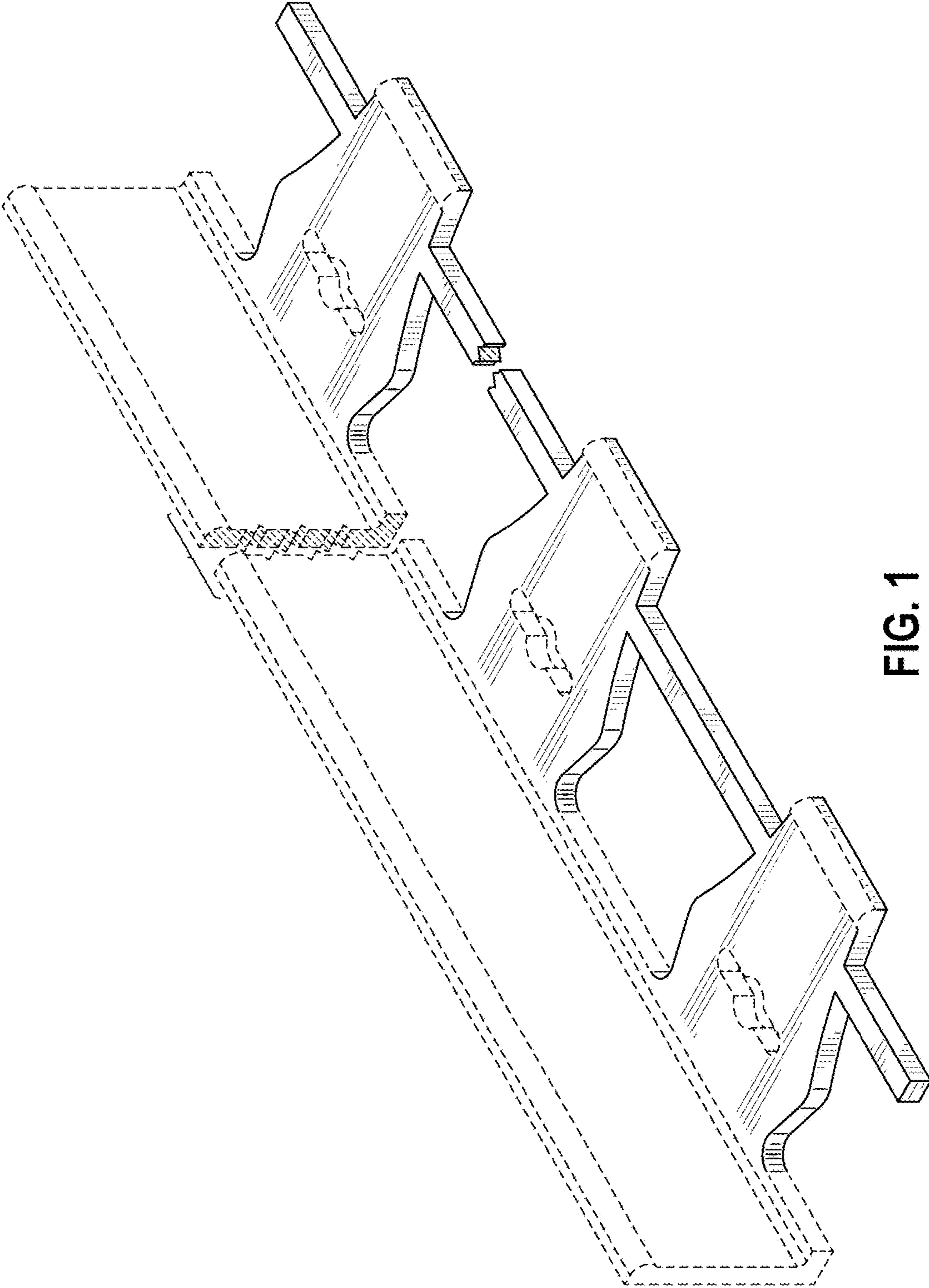

FIG. 1

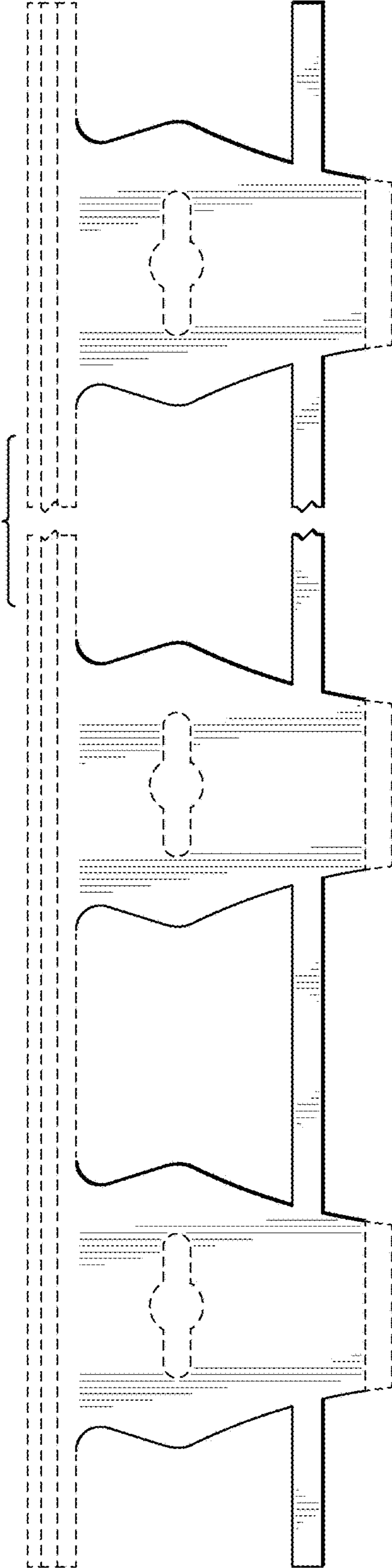

FIG. 2

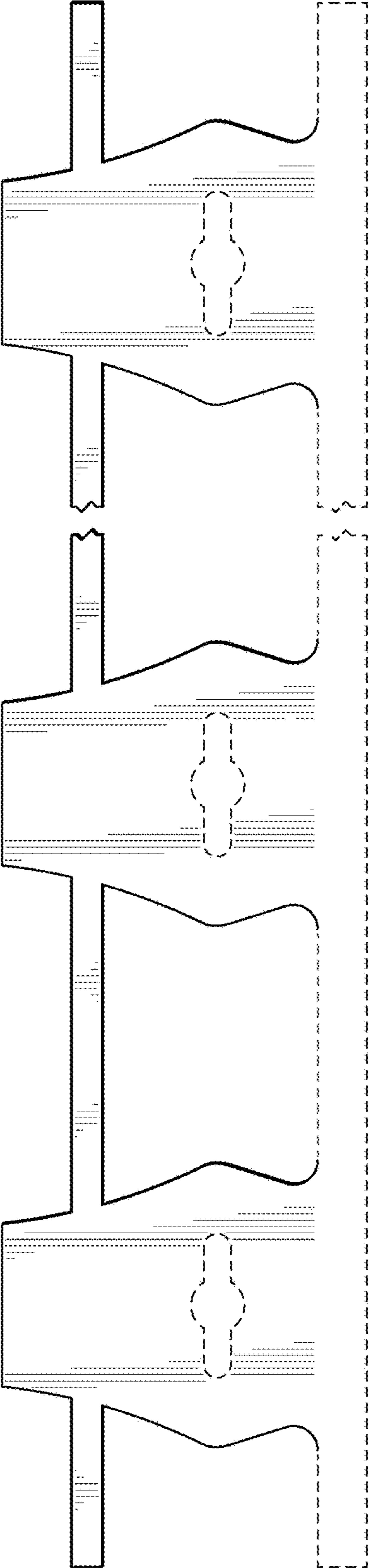

FIG. 3

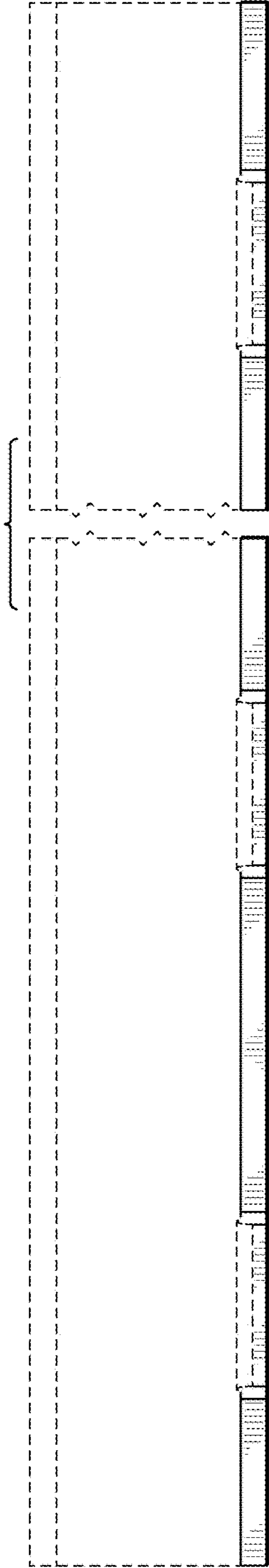

FIG. 4

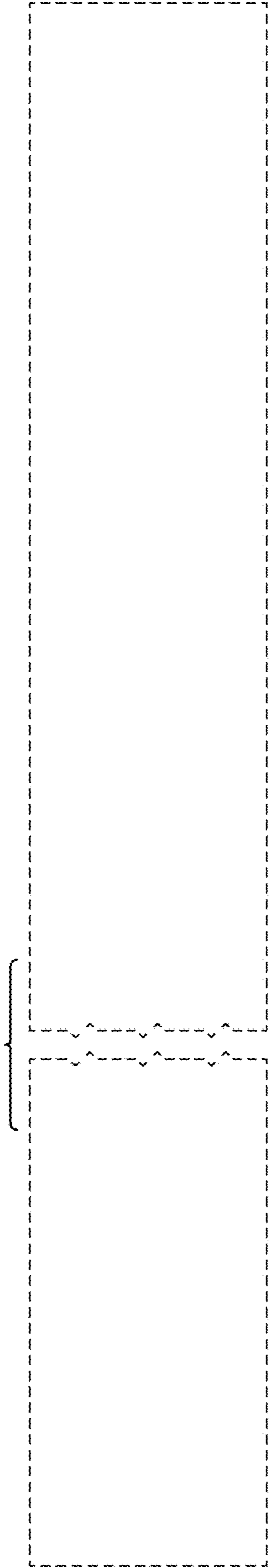

FIG. 5



FIG. 6

FIG. 7

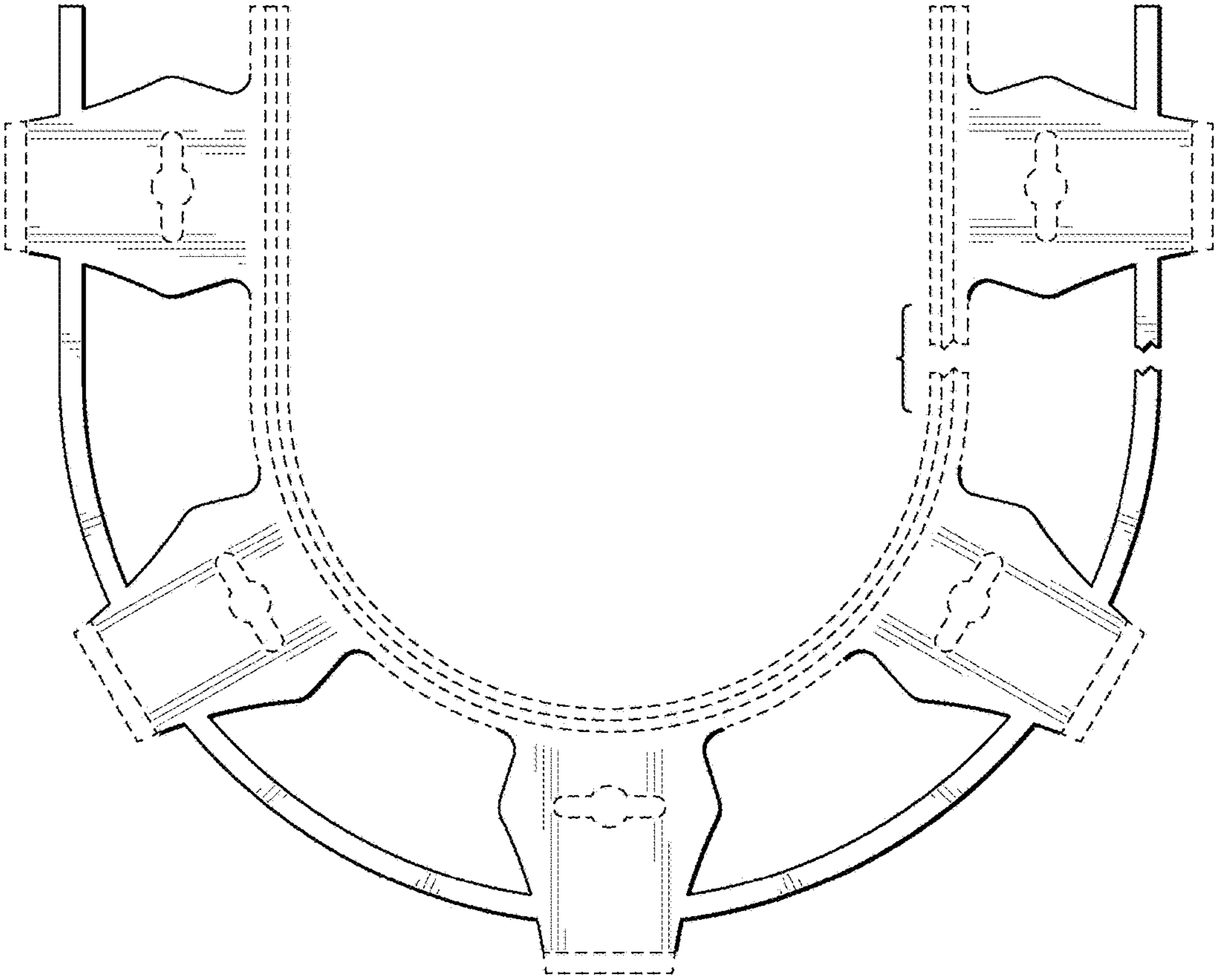

FIG. 8