



US00D827852S

(12) **United States Design Patent** (10) **Patent No.:** **US D827,852 S**
Pounders (45) **Date of Patent:** **** Sep. 4, 2018**

(54) **ADULT TOY**
(71) Applicant: **MB Technologies LLC**, Sanford, NC (US)
(72) Inventor: **John Pounders**, Nashville, TN (US)
(73) Assignee: **MB Technologies LLC**, Santa Fe, NM (US)
(**) Term: **15 Years**

2008/0188709 A1* 8/2008 Gil A61H 19/44
600/38
2008/0194907 A1* 8/2008 Lin A61H 19/44
600/38
2014/0039251 A1* 2/2014 Golan A61H 19/44
600/38
2016/0008218 A1* 1/2016 Murison A61H 19/34
601/46
2016/0015596 A1* 1/2016 Murison A61H 23/0263
600/38
2016/0045392 A1* 2/2016 Massey A61H 23/02
601/46

(21) Appl. No.: **29/610,921**
(22) Filed: **Jul. 17, 2017**
(51) **LOC (11) Cl.** **28-03**
(52) **U.S. Cl.**
USPC **D24/215**
(58) **Field of Classification Search**
USPC 601/15, 18, 19, 46, 47, 48, 52, 99, 112,
601/113, 118, 135, 137, DIG. 12,
601/DIG. 14, DIG. 15, DIG. 16, DIG. 17;
D24/200, 211, 212, 213, 214, 215;
600/38, 39
CPC A61H 19/34; A61H 19/40; A61H 19/44;
A61H 19/50; A61H 2201/0134; A61H
2201/1645; A61F 6/04
See application file for complete search history.

OTHER PUBLICATIONS

Motorbunny, "Premium Silicone My Friend Dick Penis Style Attachment", Apr. 25, 2017. <https://motorbunny.com/collections/attachments/products/premium-silicone-my-friend-dick-penis-style-attachment>. Shown on p. 1. (Year: 2017).*

* cited by examiner

Primary Examiner — Cynthia Ramirez
Assistant Examiner — Michael A Maharajh

(57) **CLAIM**

I claim the ornamental design for an adult toy, as shown and described.

DESCRIPTION

FIG. 1 is a top perspective view of an adult toy showing my new design.
FIG. 2 is a right side view thereof.
FIG. 3 is a left side view thereof.
FIG. 4 is a front side view thereof.
FIG. 5 is a rear side view thereof.
FIG. 6 is a top plan view thereof; and,
FIG. 7 is a bottom plan view thereof.
The broken lines shown in FIG. 7 are for the purpose of illustrating portions of the adult toy, which form no part of the claimed design.

(56) **References Cited**
U.S. PATENT DOCUMENTS
3,759,254 A * 9/1973 Clark A61F 6/04
600/39
D384,156 S * 9/1997 Kain D24/200
7,530,944 B1 * 5/2009 Kain A61H 19/34
600/38
D695,904 S * 12/2013 Cohen D24/211
D703,341 S * 4/2014 Cohen D24/211
D742,025 S * 10/2015 Callow D24/214
D743,042 S * 11/2015 Christian D24/215
2002/0099262 A1 * 7/2002 Knoll-Ewers A61H 19/44
600/39

1 Claim, 7 Drawing Sheets

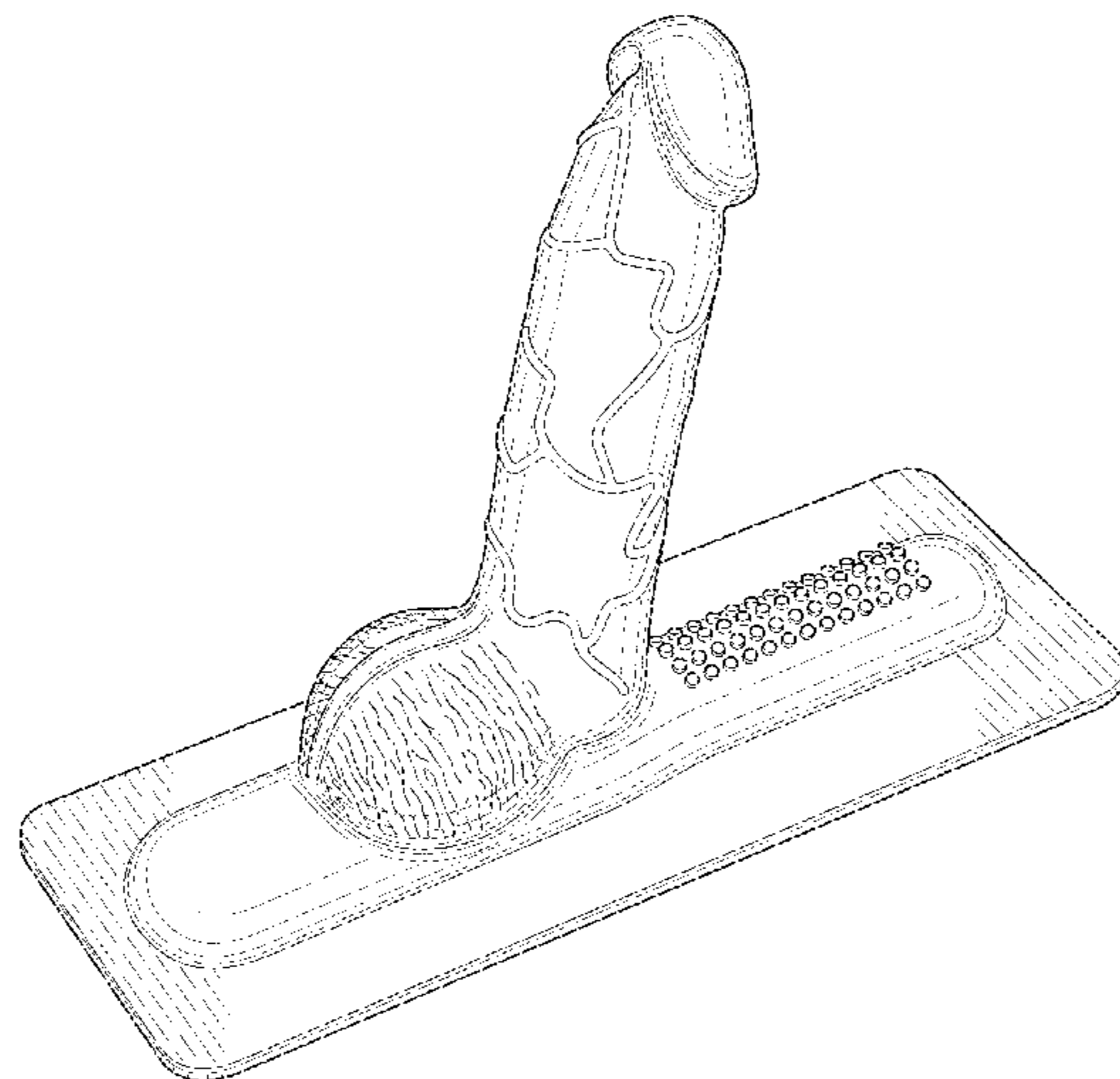

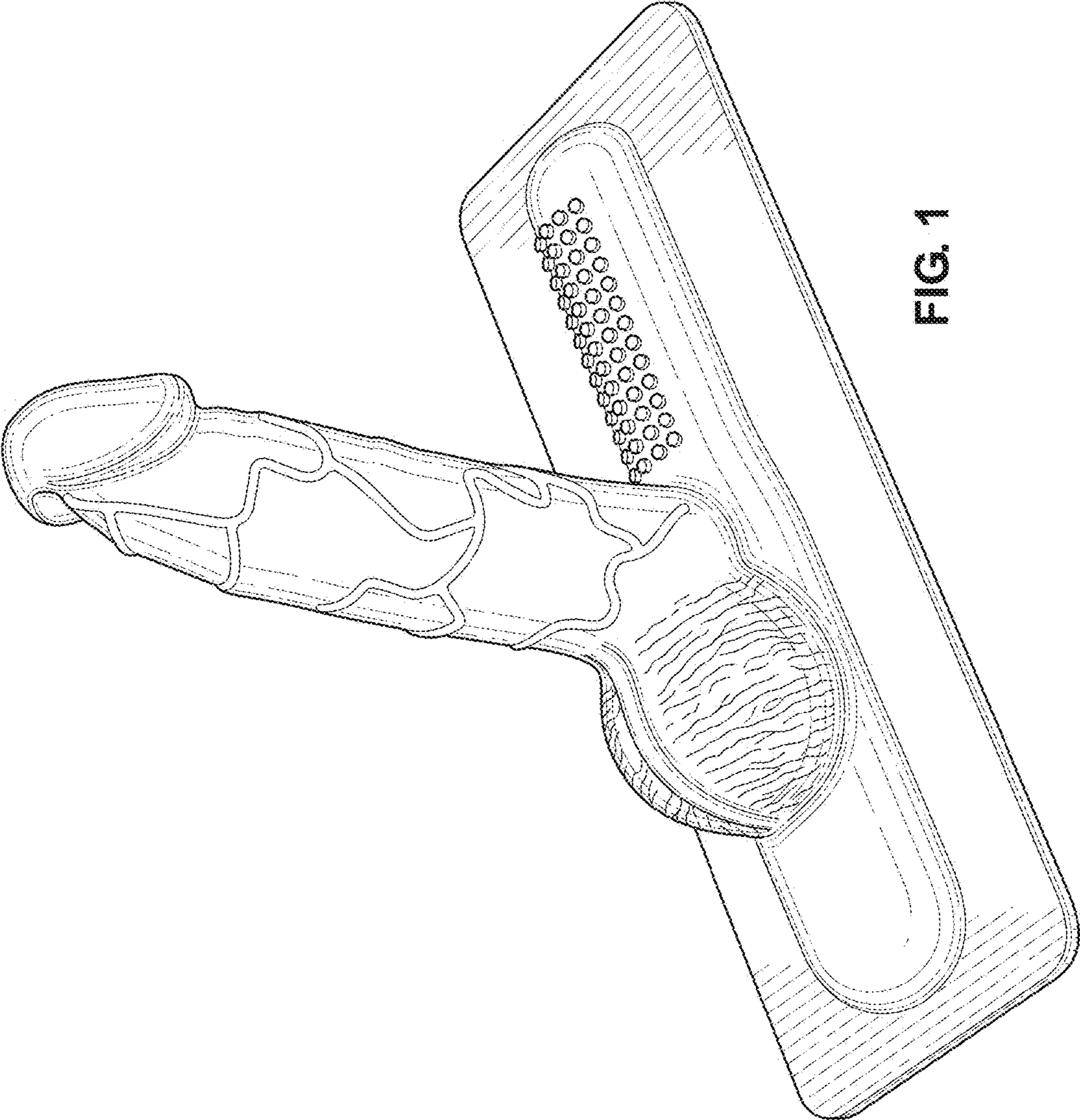

FIG. 1

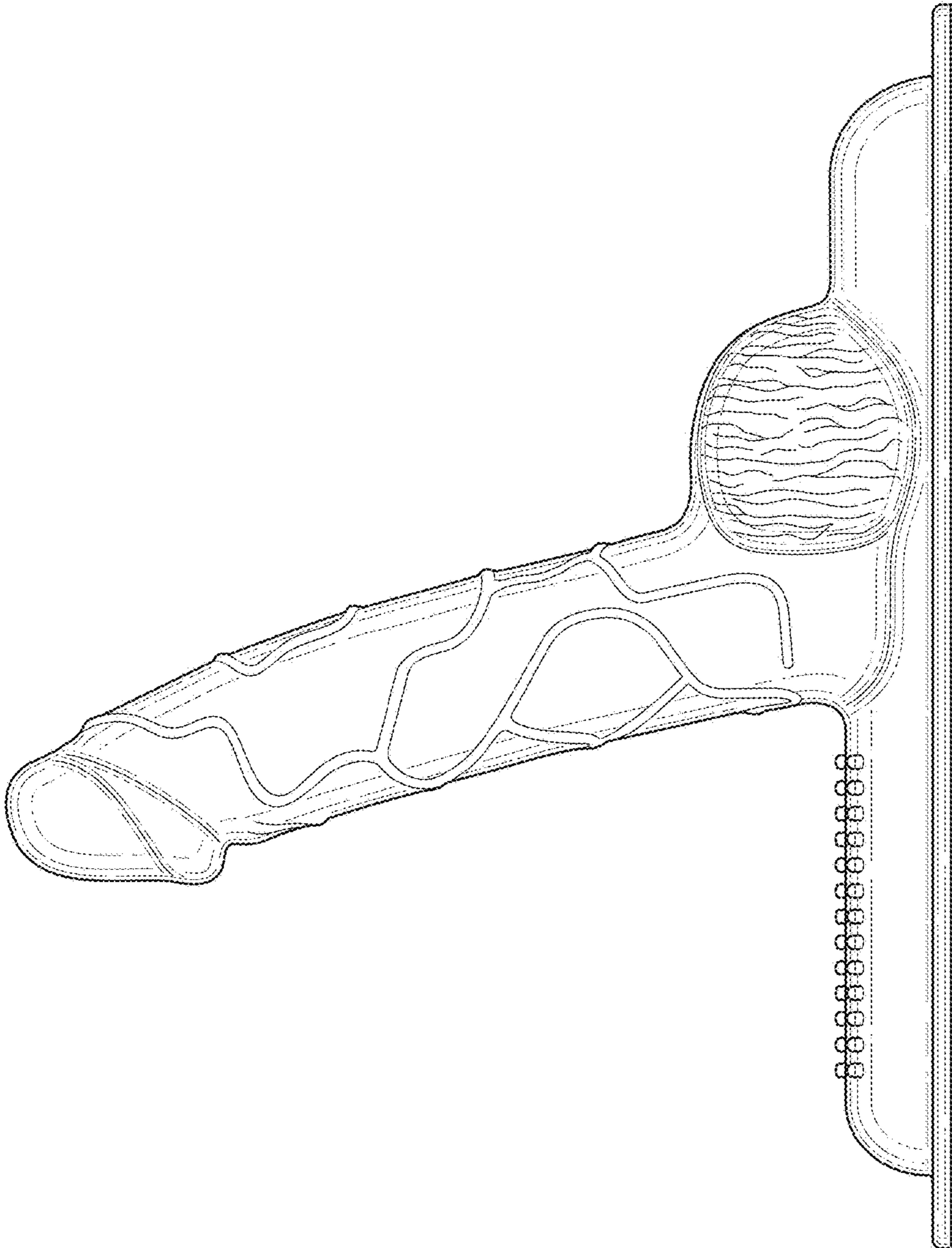

FIG. 2

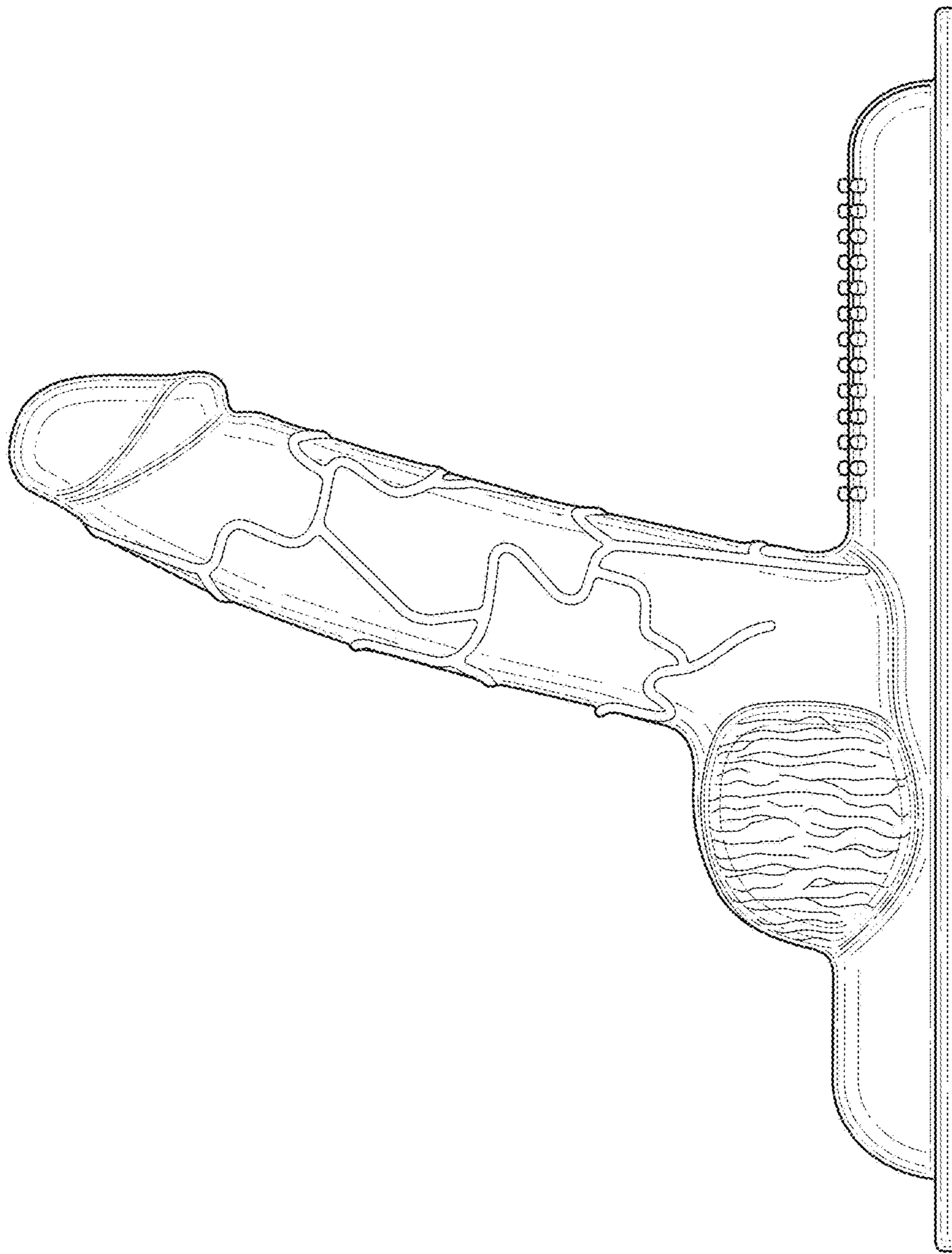

FIG. 3

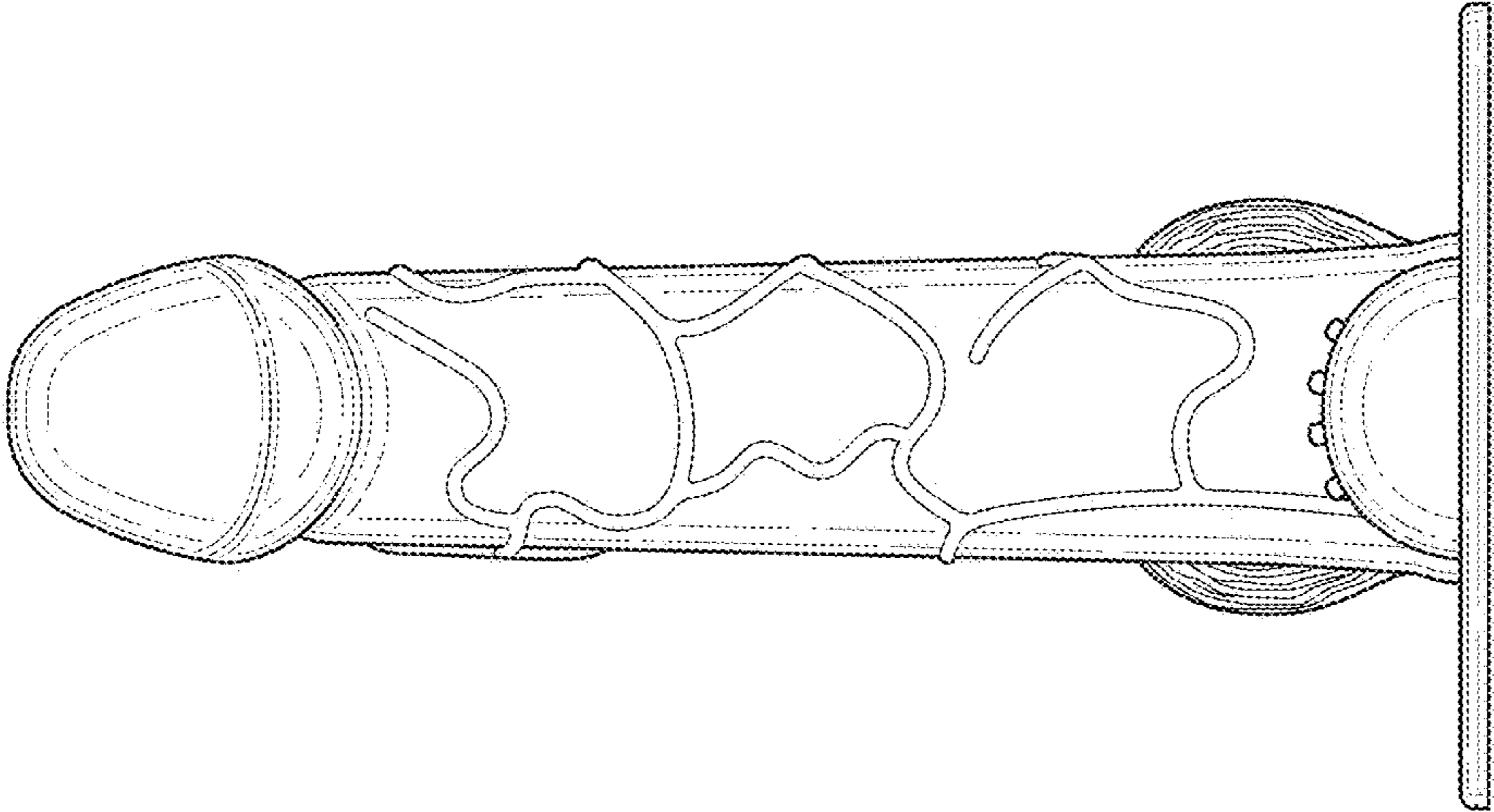

FIG. 4

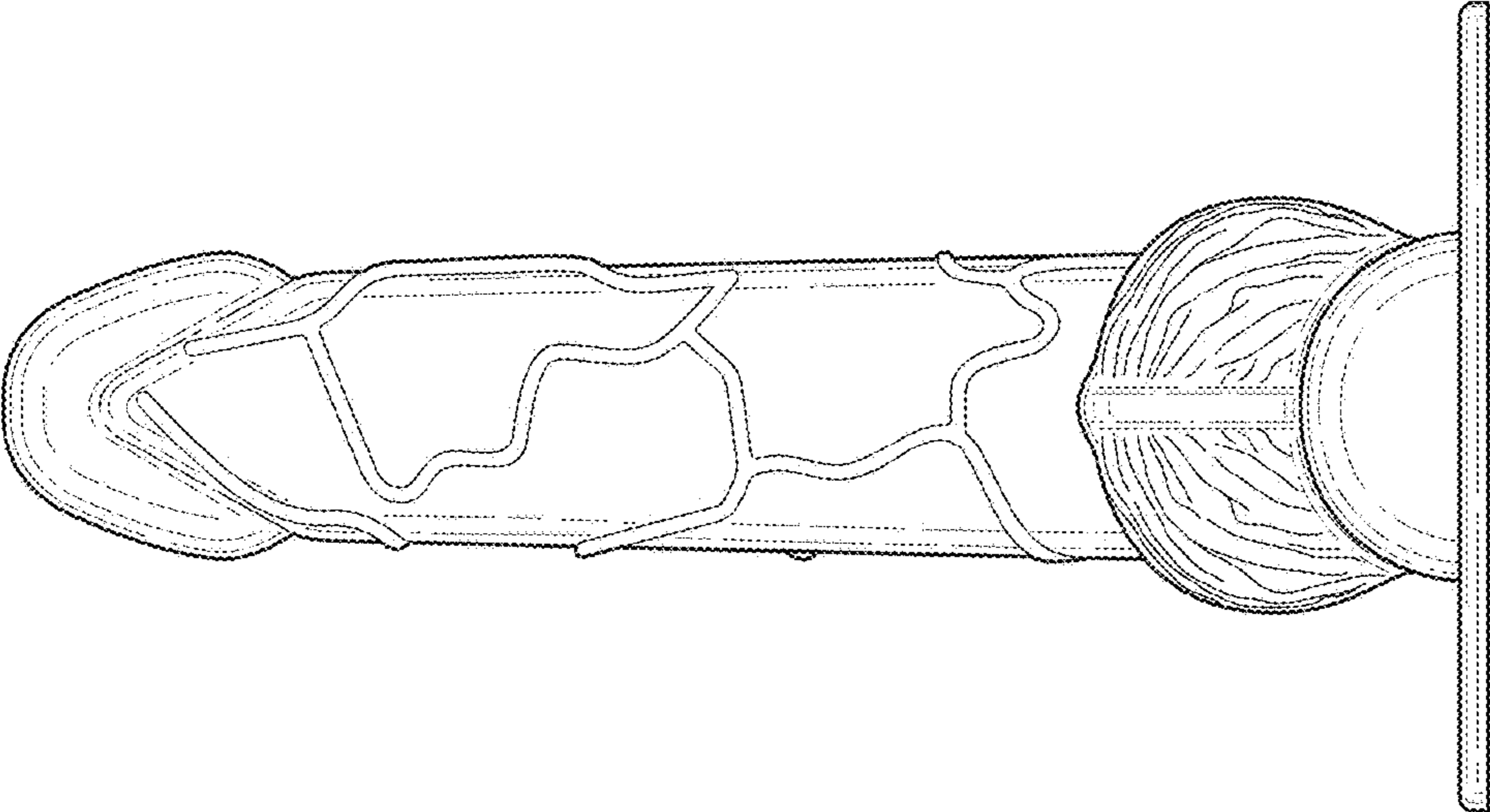

FIG. 5

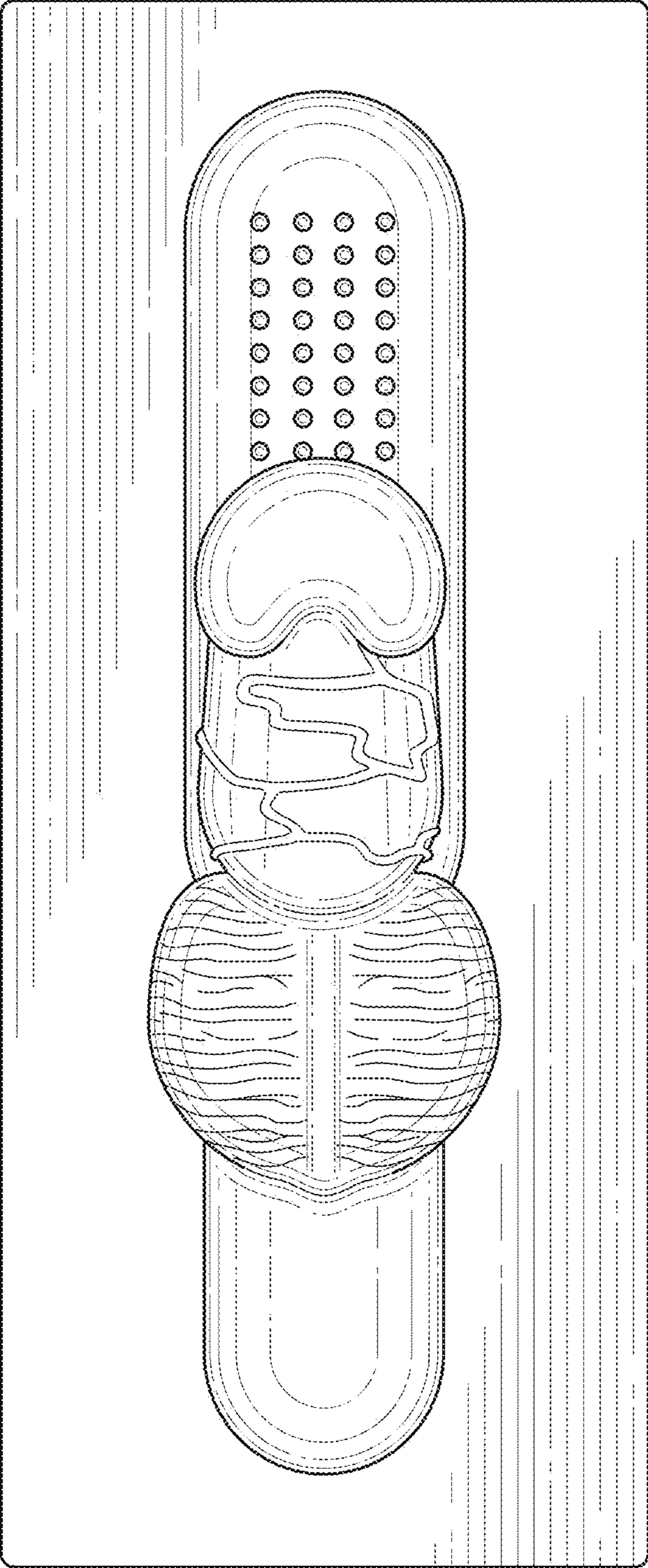

FIG. 6

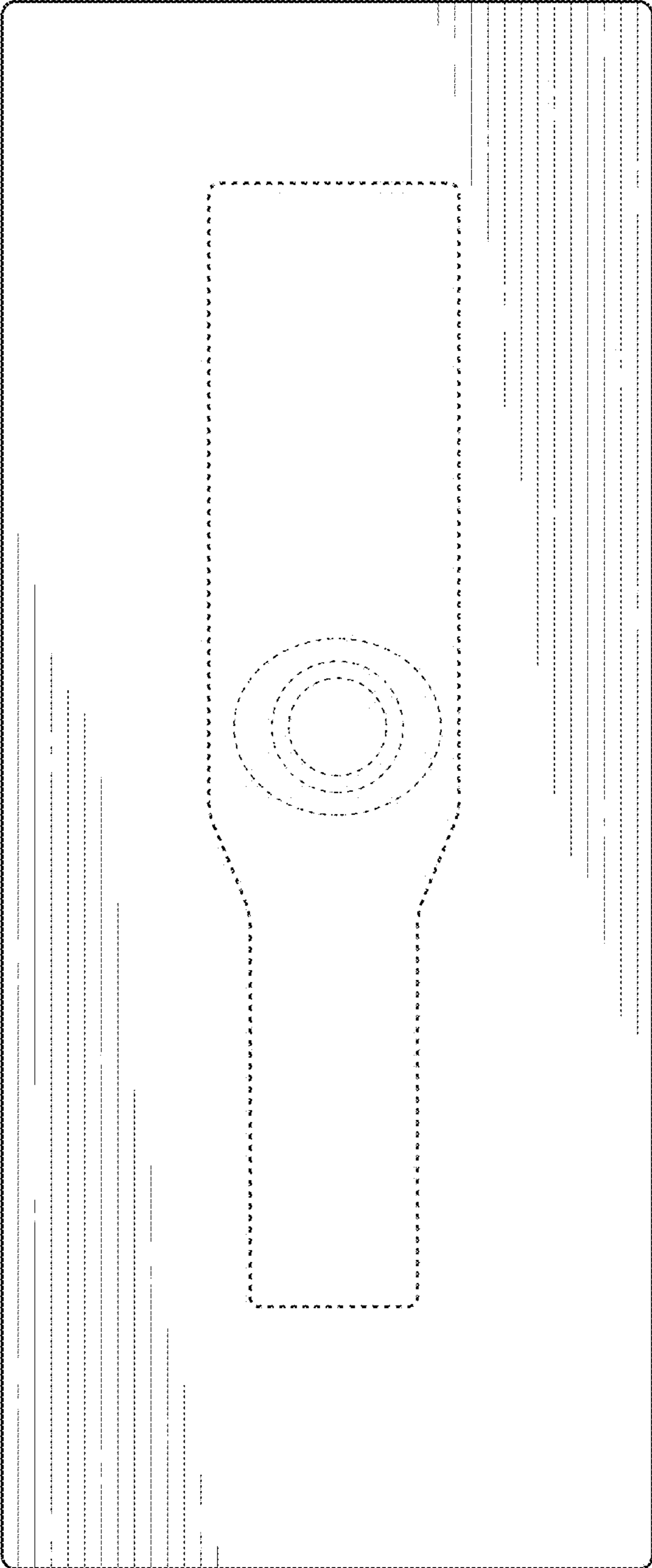

FIG. 7