



US00D827822S

(12) **United States Design Patent** (10) **Patent No.:** **US D827,822 S**  
**Anderson et al.** (45) **Date of Patent:** **\*\* Sep. 4, 2018**

(54) **SUTURING DEVICE**

(71) Applicant: **Dura Tap LLC**, Wayne, PA (US)

(72) Inventors: **David Greg Anderson**, Moorestown, NJ (US); **Mark F. Kurd**, Bryn Mawr, PA (US); **Jay Tapper**, Wayne, PA (US); **Jens Johnson**, Austin, TX (US)

(73) Assignee: **Dura Tap LLC**, Wayne, PA (US)

(\*\*) Term: **15 Years**

(21) Appl. No.: **29/595,042**

(22) Filed: **Feb. 24, 2017**

(51) **LOC (11) Cl.** ..... **24-02**

(52) **U.S. Cl.**  
 USPC ..... **D24/145**

(58) **Field of Classification Search**  
 USPC ..... D24/145-147, 133  
 CPC ..... A61B 17/0469; A61B 17/0483; A61B 17/0482; A61B 17/06166; A61B 2017/2929; A61B 2017/06176  
 See application file for complete search history.

(56) **References Cited**

U.S. PATENT DOCUMENTS

5,104,381 A \* 4/1992 Gresl ..... A61B 17/3496  
 604/158

D342,995 S \* 1/1994 Simmons ..... D24/112

5,364,410 A \* 11/1994 Failla ..... A61B 17/0469  
 606/135

D708,741 S \* 7/2014 Harrison ..... D24/145

8,974,494 B2 \* 3/2015 Paulk ..... A61B 17/0469  
 606/104

D737,971 S \* 9/2015 Wagner ..... D24/145

9,622,741 B2 \* 4/2017 Levine ..... A61B 17/0482

2004/0127915 A1\* 7/2004 Fleenor ..... A61B 17/0469  
 606/144

2007/0049966 A1\* 3/2007 Bonadio ..... A61B 17/00234  
 606/206

2016/0317144 A1\* 11/2016 Popovici ..... A61B 17/0469

2017/0020514 A1\* 1/2017 Paulk ..... A61B 17/0469

2017/0143331 A1\* 5/2017 Kurd ..... A61B 17/0469

\* cited by examiner

*Primary Examiner* — Wan Laymon  
 (74) *Attorney, Agent, or Firm* — Rankin, Hill & Clark LLP

(57) **CLAIM**

The ornamental design for a suturing device, as shown and described.

**DESCRIPTION**

FIG. 1 is a perspective view of a suturing device; FIG. 2 is a right side view thereof; FIG. 3 is a left side view thereof; FIG. 4 is a front view thereof; FIG. 5 is a rear view thereof; FIG. 6 is a top view thereof; and FIG. 7 is a bottom view thereof; FIG. 8 is a perspective view of another embodiment of the suturing device; FIG. 9 is a right side view thereof; FIG. 10 is a left side view thereof; FIG. 11 is a front view thereof; FIG. 12 is a rear view thereof; FIG. 13 is a top view thereof; and FIG. 14 is a bottom view thereof.

The broken away symbols in FIGS. 8-12 and 14 indicate the appearance of any portion of the article between the break lines forms no part of the claimed design.

**1 Claim, 6 Drawing Sheets**

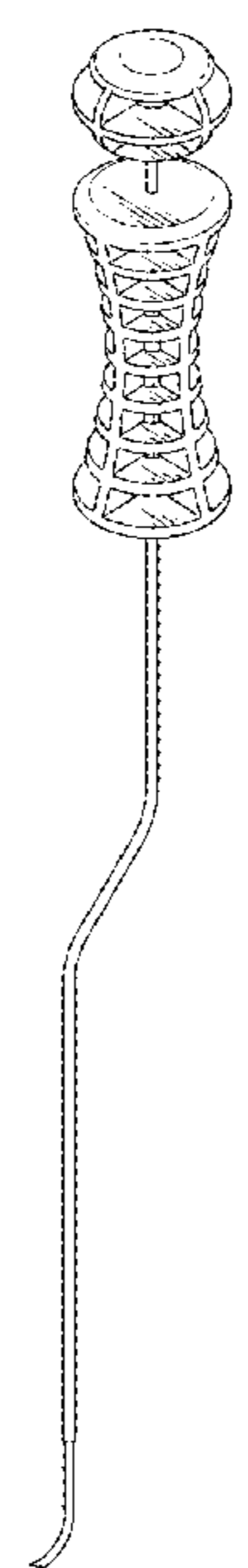

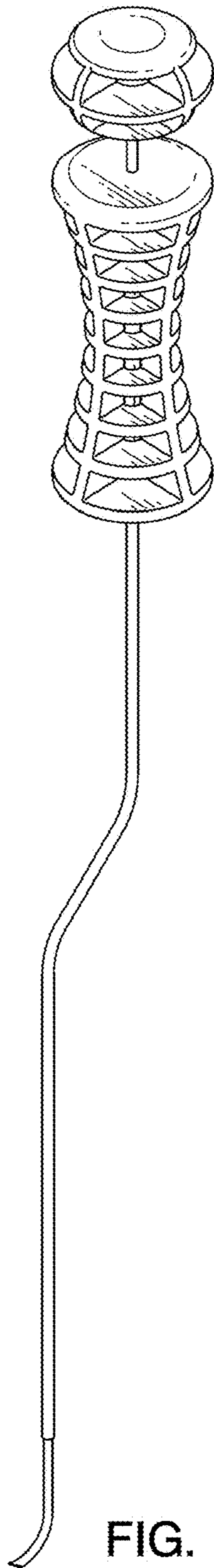

FIG. 1

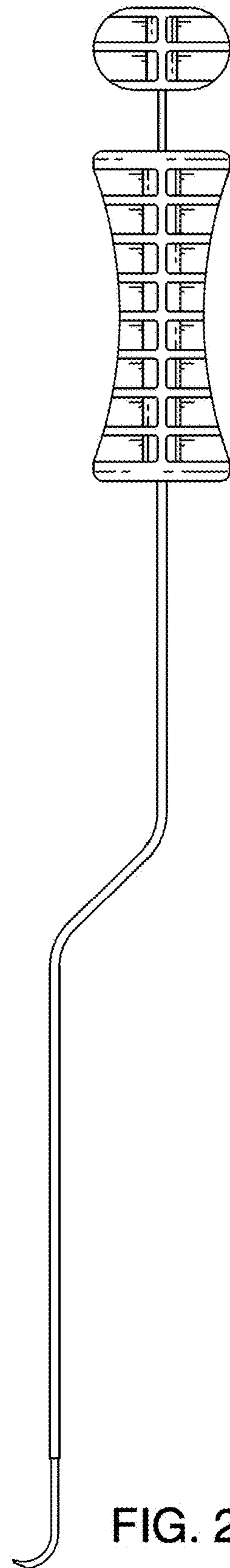

FIG. 2

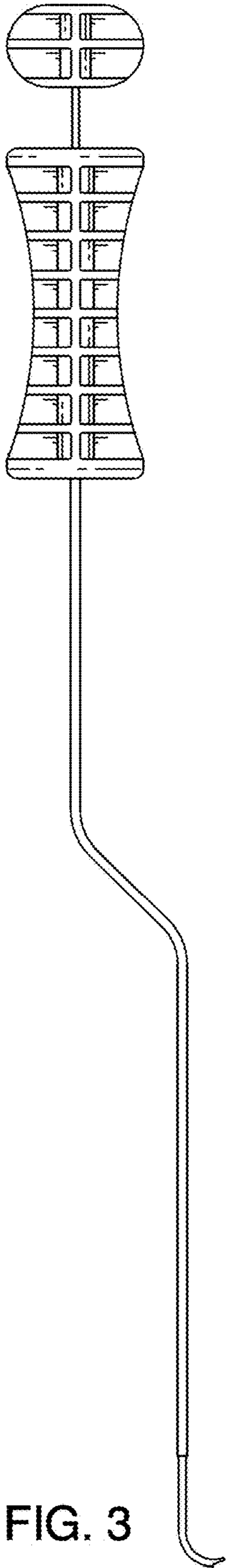

FIG. 3

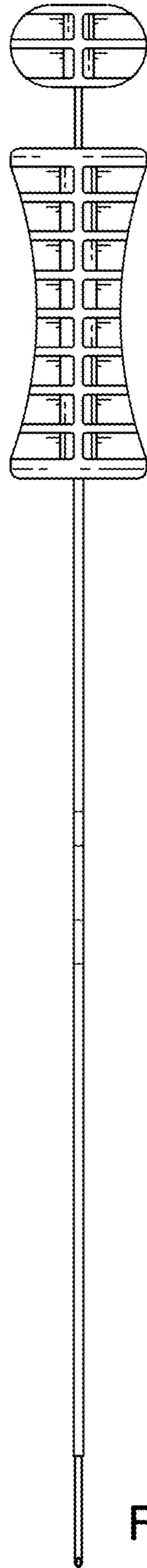

FIG. 4

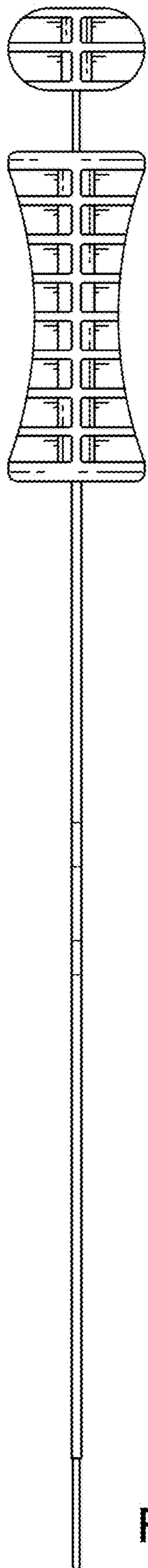

FIG. 5

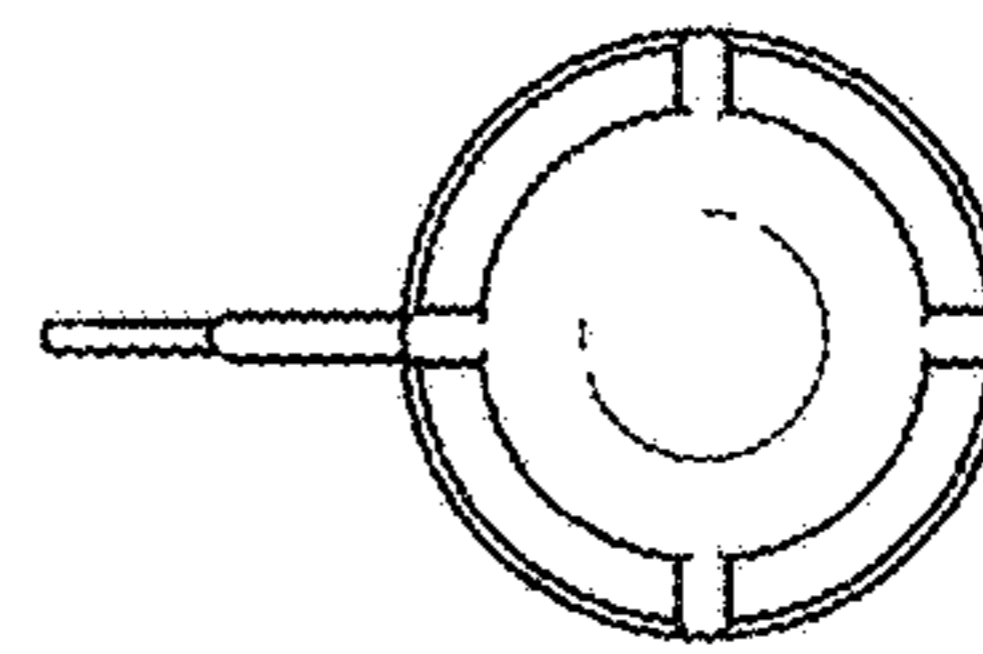

FIG. 6

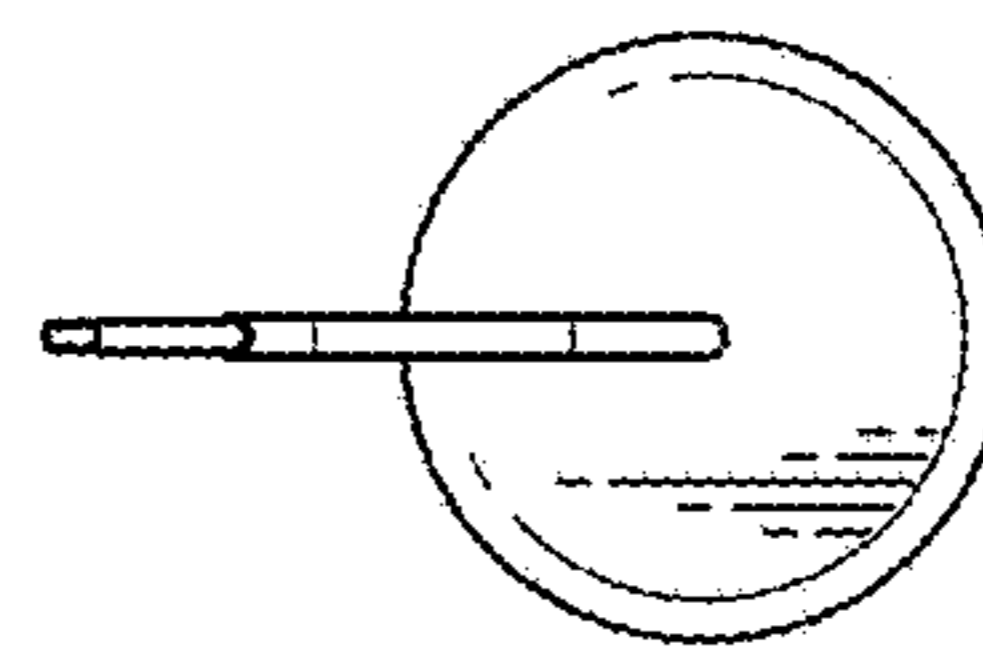

FIG. 7

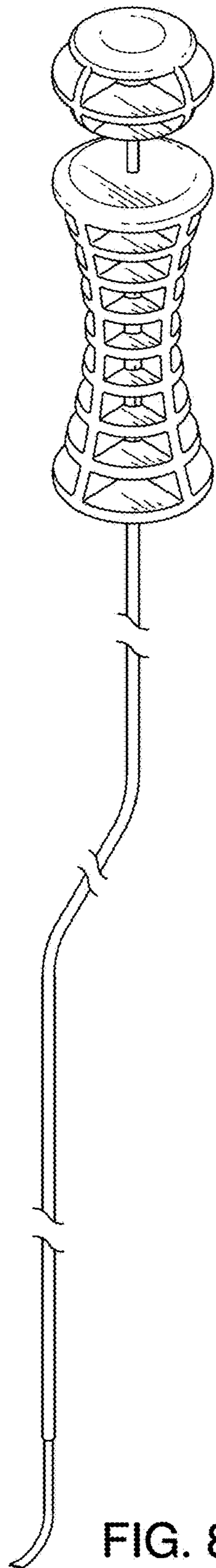

FIG. 8

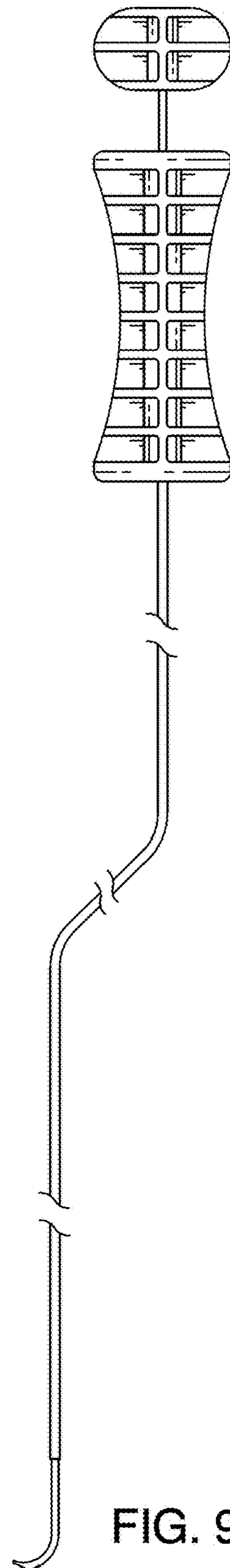

FIG. 9

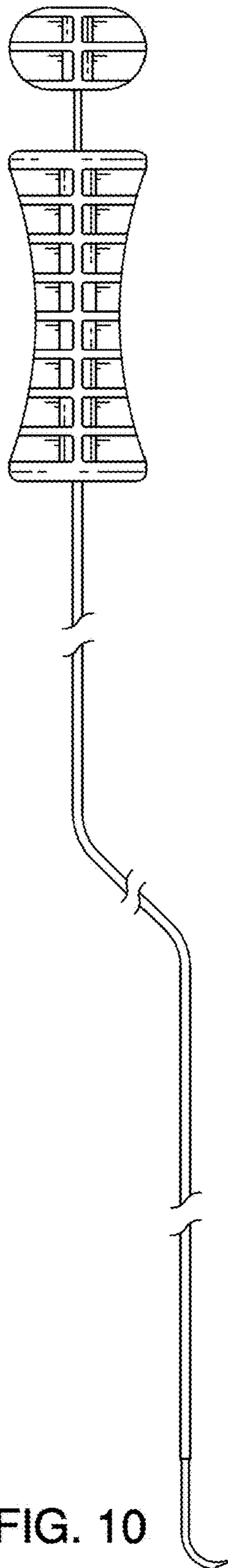

FIG. 10

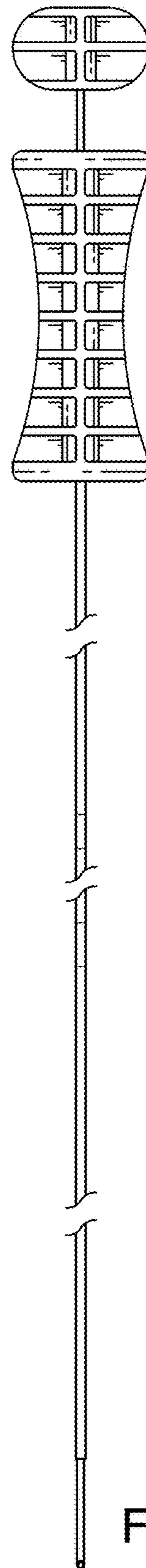

FIG. 11



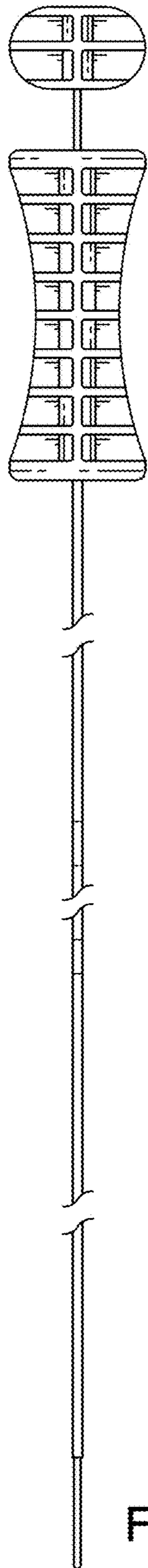

FIG. 12

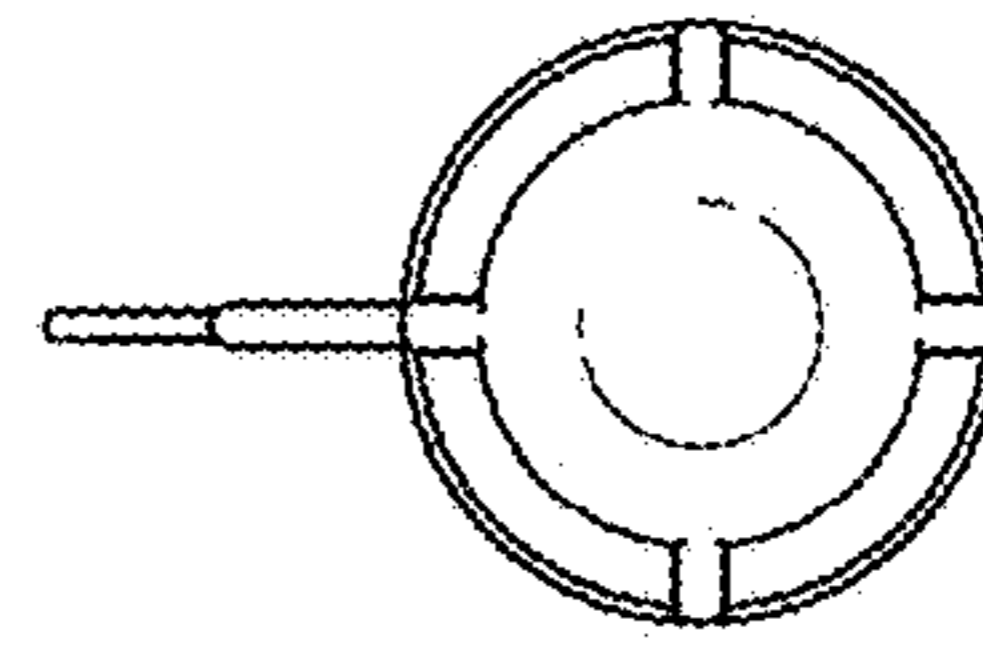

FIG. 13

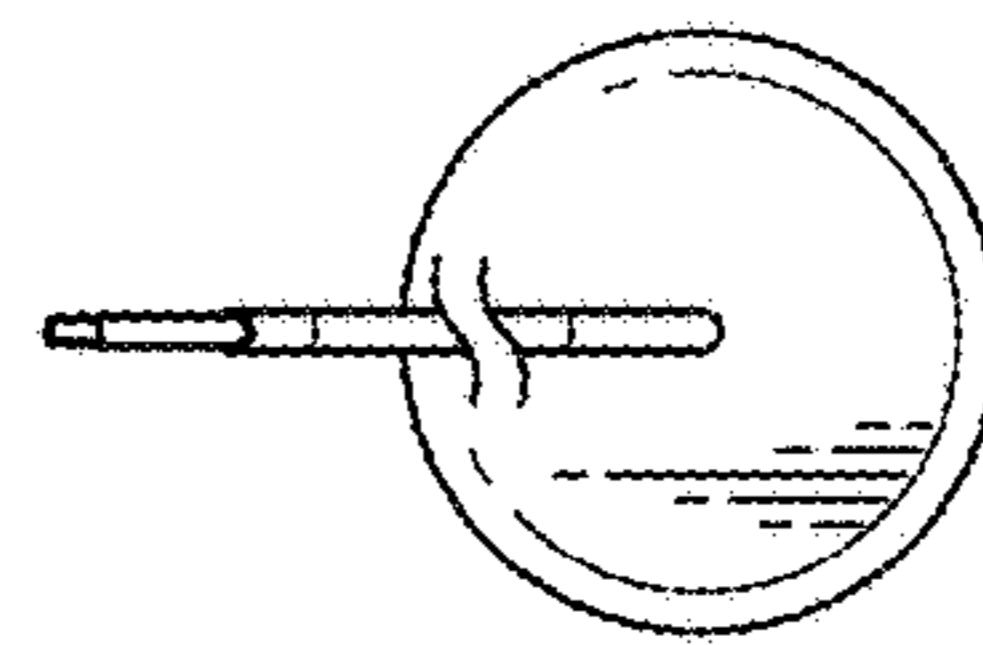

FIG. 14