



US00D827748S

(12) **United States Design Patent**  
**Desberg**

(10) **Patent No.:** **US D827,748 S**

(45) **Date of Patent:** **\*\* Sep. 4, 2018**

(54) **SKATEBOARD**

(71) Applicant: **RAZOR USA LLC**, Cerritos, CA (US)

(72) Inventor: **Ian Desberg**, Cerritos, CA (US)

(73) Assignee: **Razor USA LLC**, Cerritos, CA (US)

(\*\*) Term: **15 Years**

(21) Appl. No.: **29/611,372**

(22) Filed: **Jul. 20, 2017**

D246,065 S 10/1977 Saul  
4,060,253 A 11/1977 Oldendorf  
4,076,267 A 2/1978 Lipscomb  
4,082,306 A 4/1978 Sheldon  
4,092,033 A 5/1978 Swain  
4,093,252 A 6/1978 Rue

(Continued)

**FOREIGN PATENT DOCUMENTS**

GB 2318519 4/1998  
GB 2464676 4/2010

(Continued)

**OTHER PUBLICATIONS**

Micelle' Electric Wave Board [XinCheJian], URL—<http://xinchejian.com/2011/05/07/micelles-electric-wave-board/>, May 7, 2011.

(Continued)

*Primary Examiner* — Cynthia M Chin

(74) *Attorney, Agent, or Firm* — Knobbe Martens Olson & Bear, LLP

**Related U.S. Application Data**

(63) Continuation of application No. 29/582,281, filed on Oct. 26, 2016, now Pat. No. Des. 792,931, which is a continuation of application No. 29/525,837, filed on May 4, 2015, now Pat. No. Des. 770,585.

(51) **LOC (11) Cl.** ..... **21-02**

(52) **U.S. Cl.**

USPC ..... **D21/765**

(58) **Field of Classification Search**

USPC ..... D21/419, 421, 423, 426, 760, 765, 766,  
D21/769, 771, 776, 803; 280/7.14,  
280/11.115, 11.19, 11.27, 11.28, 14.21,  
280/87.01, 87.021, 87.03, 87.041, 87.042,  
280/607, 608, 609, 809; 180/180, 181;  
434/247, 253, 258

CPC ..... A63C 17/01; A63C 17/011; A63C 17/012;  
A63C 17/014; A63C 17/015; A63C  
17/02; A63C 17/26; A63C 5/003; B60Q  
1/326; B62K 3/001

See application file for complete search history.

(57)

**CLAIM**

The ornamental design for a skateboard, as shown and described.

**DESCRIPTION**

FIG. 1 is a front perspective view of a skateboard, which embodies my design.

FIG. 2 is a front view of the skateboard of FIG. 1.

FIG. 3 is a rear view of the skateboard of FIG. 1.

FIG. 4 is a right side view of the skateboard of FIG. 1. The left side view is a mirror image of the right side view.

FIG. 5 is a top view of the skateboard of FIG. 1; and,

FIG. 6 is a bottom view of the skateboard of FIG. 1.

Broken lines are used to illustrate portions of the skateboard which form no part of the claimed design.

(56)

**References Cited**

**U.S. PATENT DOCUMENTS**

2,051,762 A 8/1936 Vincent  
3,399,906 A 9/1968 Portnoff  
3,982,766 A 9/1976 Budge  
D243,206 S 1/1977 Sherwood

**1 Claim, 5 Drawing Sheets**

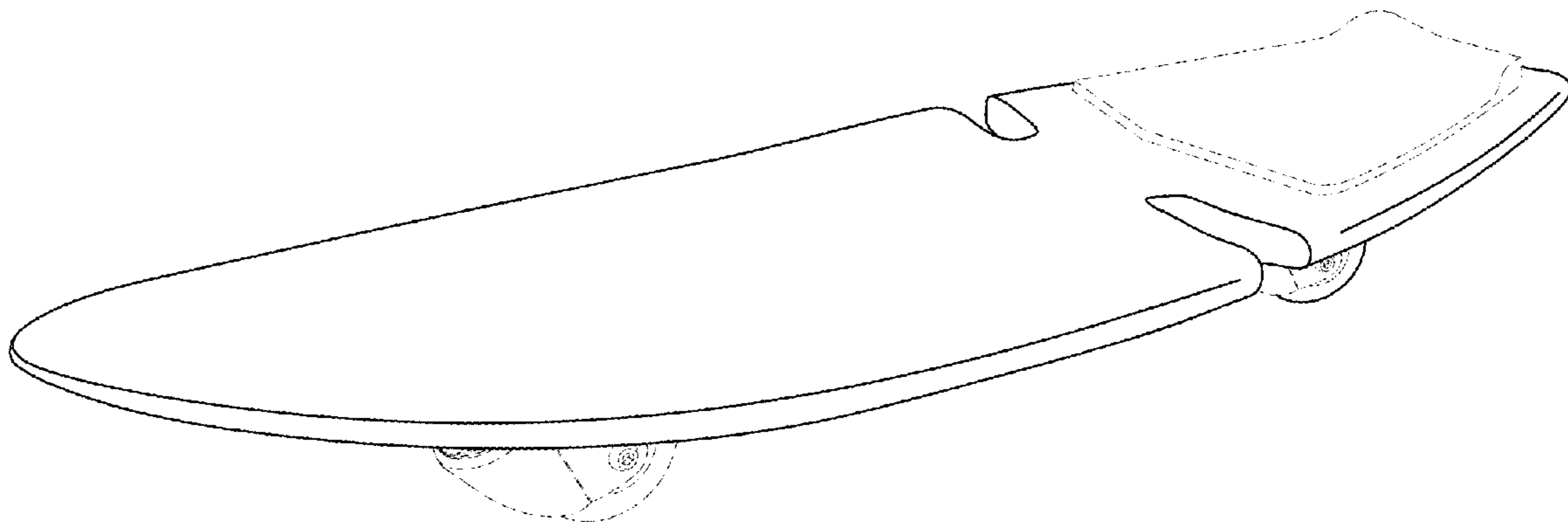

(56)

References Cited

U.S. PATENT DOCUMENTS

D250,492 S 12/1978 Kish  
 4,140,326 A 2/1979 Huber  
 4,245,848 A 1/1981 Dudouyt  
 4,295,656 A 10/1981 Moore  
 4,411,442 A 10/1983 Rills  
 4,915,403 A 4/1990 Wild  
 4,921,513 A 5/1990 Parten  
 4,930,794 A 6/1990 Chan  
 4,955,626 A 9/1990 Smith  
 5,098,087 A 3/1992 Matile  
 5,160,155 A 11/1992 Barachet  
 5,267,743 A 12/1993 Smisek  
 D345,406 S 3/1994 Shankland  
 D346,418 S 4/1994 Fischbach  
 5,330,026 A 7/1994 Hsu et al.  
 5,419,570 A 5/1995 Bollotte  
 5,458,351 A 10/1995 Yu  
 5,505,474 A 4/1996 Yeh  
 5,540,455 A 7/1996 Chambers  
 5,549,331 A 8/1996 Yun  
 5,566,956 A 10/1996 Wang  
 5,601,299 A 2/1997 Yun  
 5,622,759 A 4/1997 Fuster  
 5,707,068 A 1/1998 Bradfield  
 5,826,895 A 10/1998 Bradfield  
 5,853,182 A 12/1998 Finkle  
 5,855,385 A 1/1999 Hambsch  
 5,893,425 A 4/1999 Finkle  
 D410,515 S 6/1999 Alexander  
 D413,954 S 9/1999 Gerlach  
 5,984,328 A 11/1999 Tipton  
 D422,661 S \* 4/2000 Edwards ..... D21/765  
 D422,662 S 4/2000 Edwards et al.  
 6,059,303 A 5/2000 Bradfield  
 6,102,415 A 8/2000 Stewardson  
 6,193,249 B1 2/2001 Buscaglia  
 6,206,389 B1 3/2001 Yagi  
 6,254,113 B1 7/2001 Dornan  
 D456,047 S 4/2002 Mandic  
 6,494,467 B1 12/2002 Menges  
 6,502,850 B1 1/2003 Schaller et al.  
 6,669,215 B2 12/2003 Laporte  
 D503,763 S 4/2005 Morgan  
 D506,427 S 6/2005 Weber  
 6,910,698 B2 6/2005 Turner et al.  
 6,979,006 B2 12/2005 Pierron  
 7,044,486 B2 5/2006 Wright  
 7,083,178 B2 8/2006 Potter  
 7,195,259 B2 3/2007 Gang  
 7,198,280 B2 4/2007 Hara  
 D552,201 S 10/2007 Kwak  
 D556,283 S 11/2007 Hamborg et al.  
 D564,613 S 3/2008 Hamborg  
 7,338,056 B2 3/2008 Chen et al.  
 7,367,572 B2 5/2008 Jiang  
 D572,332 S 7/2008 Sramek et al.  
 D577,789 S 9/2008 Mazur  
 D607,521 S \* 1/2010 Chables Sandoval ..... D21/769  
 D607,524 S \* 1/2010 Marciano ..... D21/769  
 D608,851 S 1/2010 Hillman  
 D614,714 S 4/2010 Walworth  
 7,775,534 B2 8/2010 Chen et al.  
 D638,494 S \* 5/2011 Scolari ..... D21/423  
 D655,772 S 3/2012 Bin  
 D673,233 S \* 12/2012 Baggett ..... D21/769  
 8,414,000 B2 4/2013 Chen  
 8,469,376 B2 6/2013 Kristiansen

D692,079 S \* 10/2013 Mackay ..... D21/765  
 D692,080 S \* 10/2013 Hamborg ..... D21/765  
 8,632,084 B2 1/2014 Lovley, II et al.  
 D698,881 S 2/2014 Hamborg  
 D699,803 S 2/2014 Yamabe  
 D705,372 S 5/2014 Harris  
 8,857,831 B1 10/2014 Rotondo  
 8,915,506 B2 12/2014 Piacessi et al.  
 D724,166 S \* 3/2015 Hamborg ..... D21/765  
 D728,048 S 4/2015 Stover  
 D739,906 S 9/2015 Chen  
 9,186,570 B1 \* 11/2015 Wells ..... A63C 17/013  
 D770,585 S 11/2016 Desberg  
 D785,115 S 4/2017 Ying  
 D790,015 S \* 6/2017 Tan ..... D21/765  
 9,682,309 B2 6/2017 Huang  
 D792,931 S 7/2017 Desberg  
 2002/0043774 A1 4/2002 Chou  
 2002/0149166 A1 10/2002 Potter  
 2003/0124923 A1 7/2003 Mercer  
 2003/0155733 A1 8/2003 Tan et al.  
 2004/0262872 A1 12/2004 Kang  
 2006/0049595 A1 3/2006 Crigler  
 2006/0055137 A1 3/2006 Jiang  
 2006/0163830 A1 7/2006 Kwak  
 2007/0001414 A1 1/2007 Kang  
 2007/0272465 A1 11/2007 Su  
 2007/0273118 A1 11/2007 Conrad  
 2009/0200764 A1 8/2009 Jang et al.  
 2011/0037238 A1 2/2011 Devine  
 2012/0007331 A1 1/2012 Hsieh  
 2012/0187648 A1 7/2012 Chen  
 2013/0001910 A1 1/2013 Hsu  
 2014/0210175 A1 \* 7/2014 Hsu ..... A63C 17/012  
 280/87.042  
 2018/0015354 A1 1/2018 Huang

FOREIGN PATENT DOCUMENTS

JP H01-117385 U 8/1989  
 JP 2001-029663 2/2001  
 KR 1020050060368 6/2005  
 KR 200410530 3/2006  
 SU 1405865 4/1986  
 WO WO 1993/01870 A1 2/1993  
 WO WO 2002/040116 5/2002  
 WO WO 2004/105901 A1 12/2004  
 WO WO 2006/022472 3/2006  
 WO WO 2007/102645 9/2007  
 WO WO 2007/117092 10/2007  
 WO WO 2009/036074 3/2009  
 WO WO 2016/086066 6/2016

OTHER PUBLICATIONS

About: Skateboarding; The Wave <http://skateboard.about.com/cs/fringeboarding/gr/XBoard.html>, retrieved Jan. 17, 2007.  
 PCT Search Report and Written Opinion for International Application No. PCT/US2015/062534 dated Feb. 15, 2016.  
 The Wave, Streetsurfing, <http://www.street surfing .com/wave/ skating .html>, retrieved Mar. 8, 2007.  
 "About: Skateboarding; Other Boardsports", <http://skateboard.about .com/cs/fringeboarding/gr/?once-true&;>, retrieved Mar. 8, 2007.  
 International Preliminary Report on Patentability for International Application No. PCT/US2015/062534, dated Jun. 8, 2017, in 8 pages.

\* cited by examiner

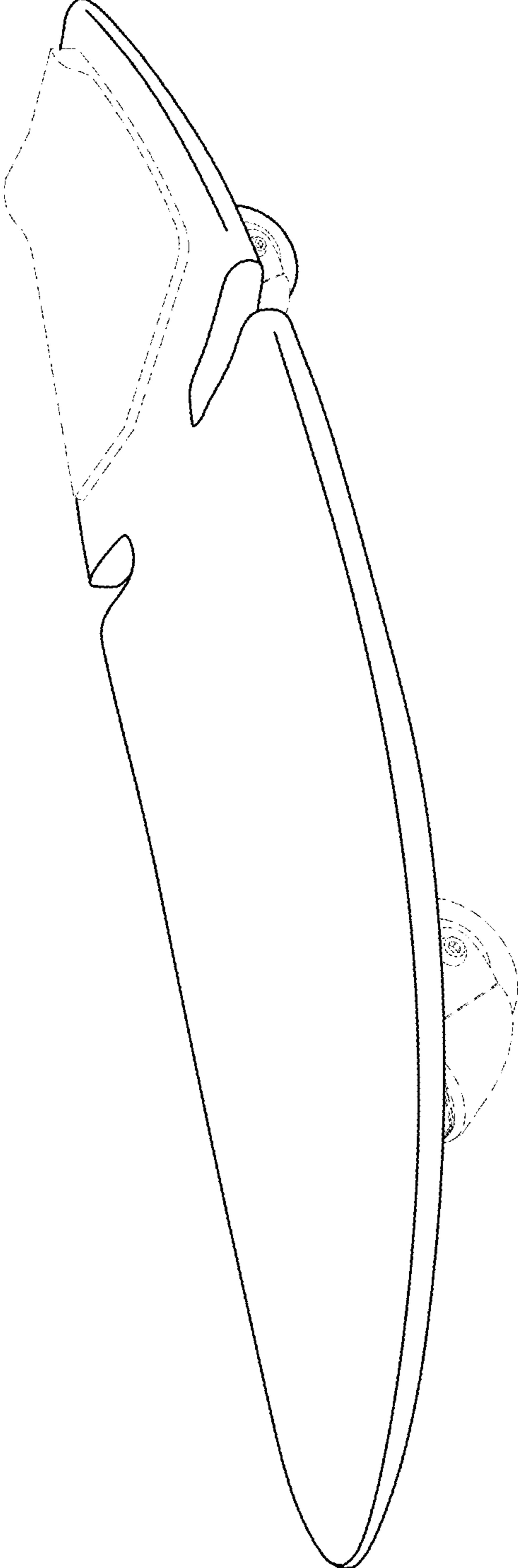

*FIG. 1*

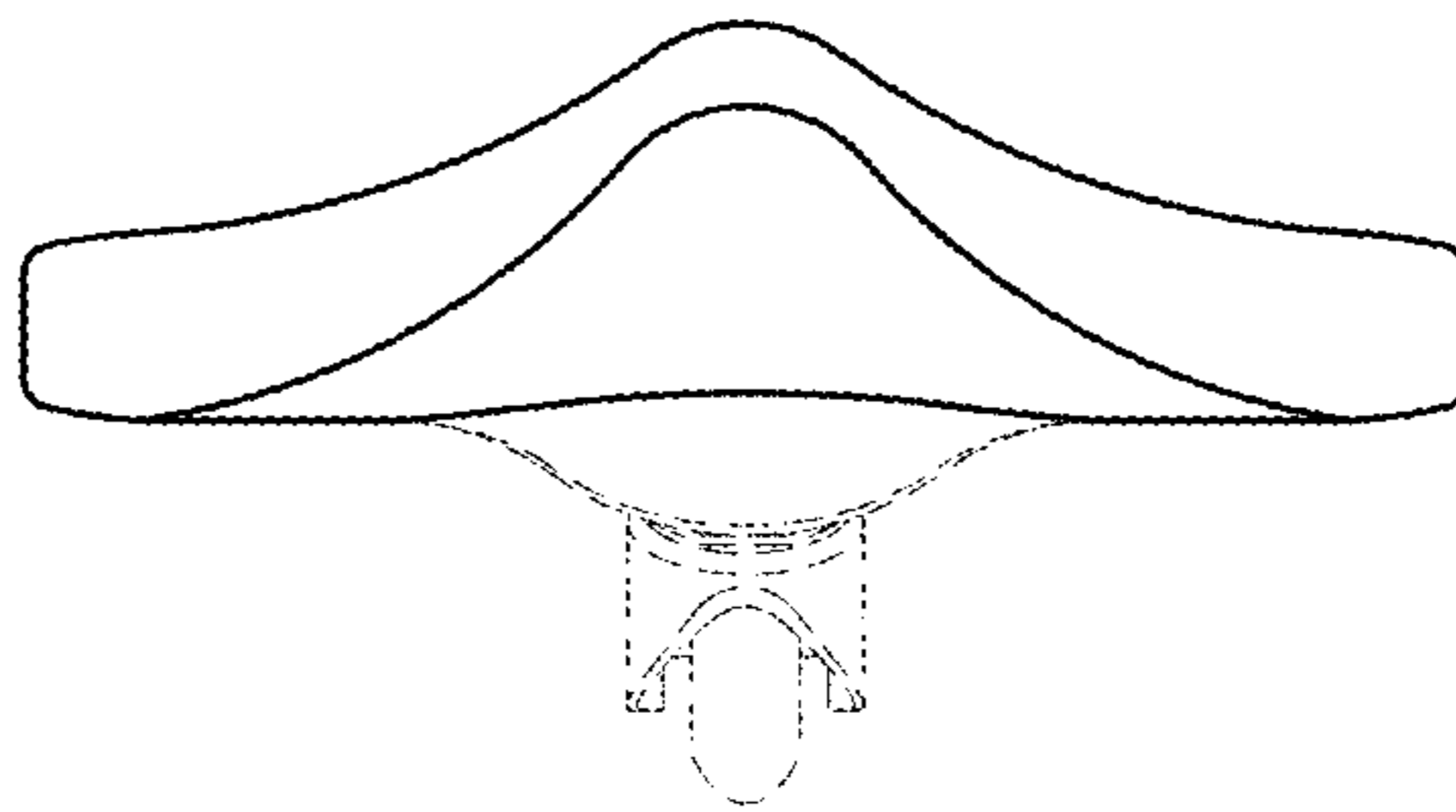

*FIG. 2*

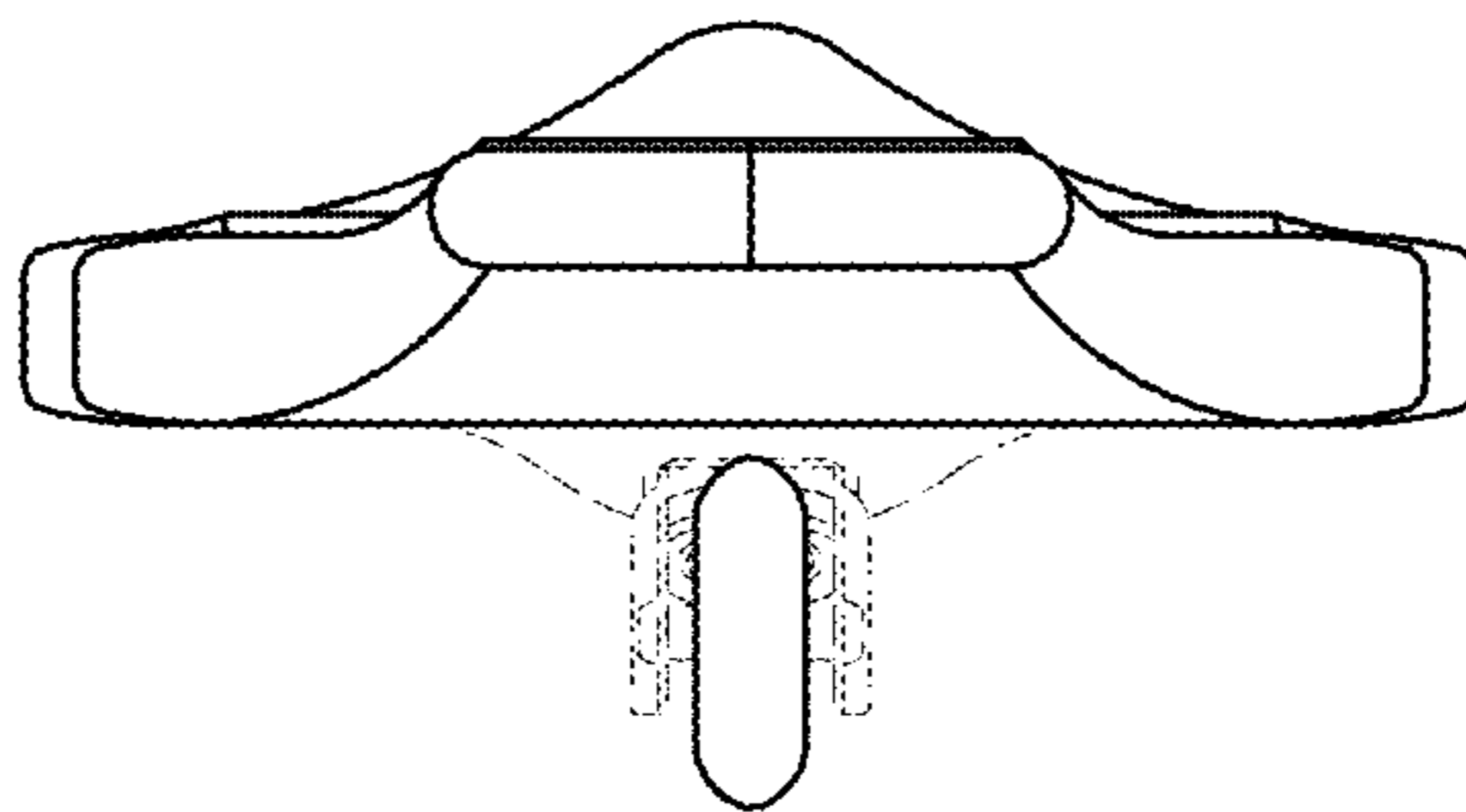

*FIG. 3*

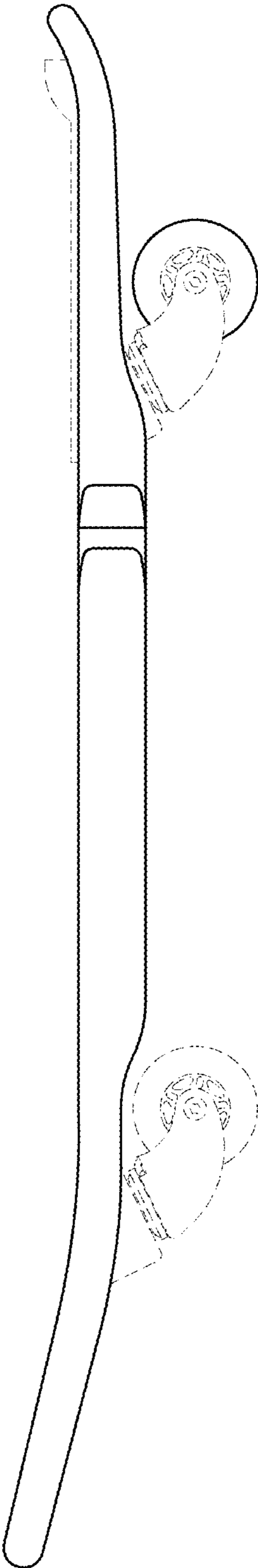

*FIG. 4*

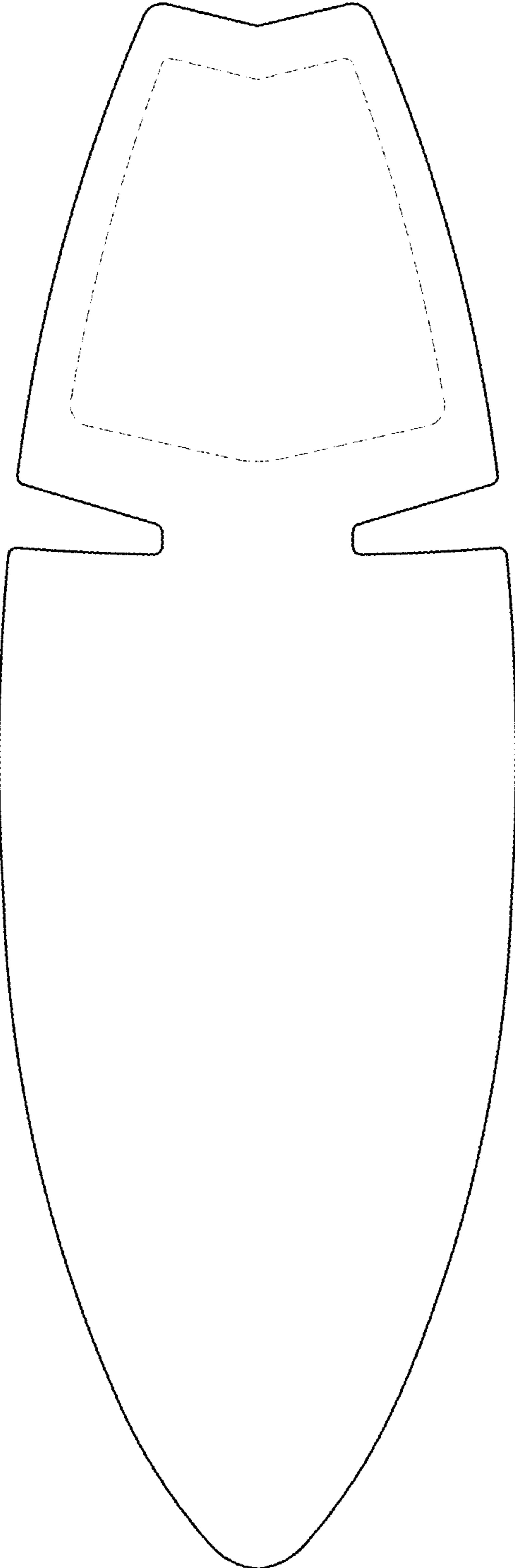

*FIG. 5*

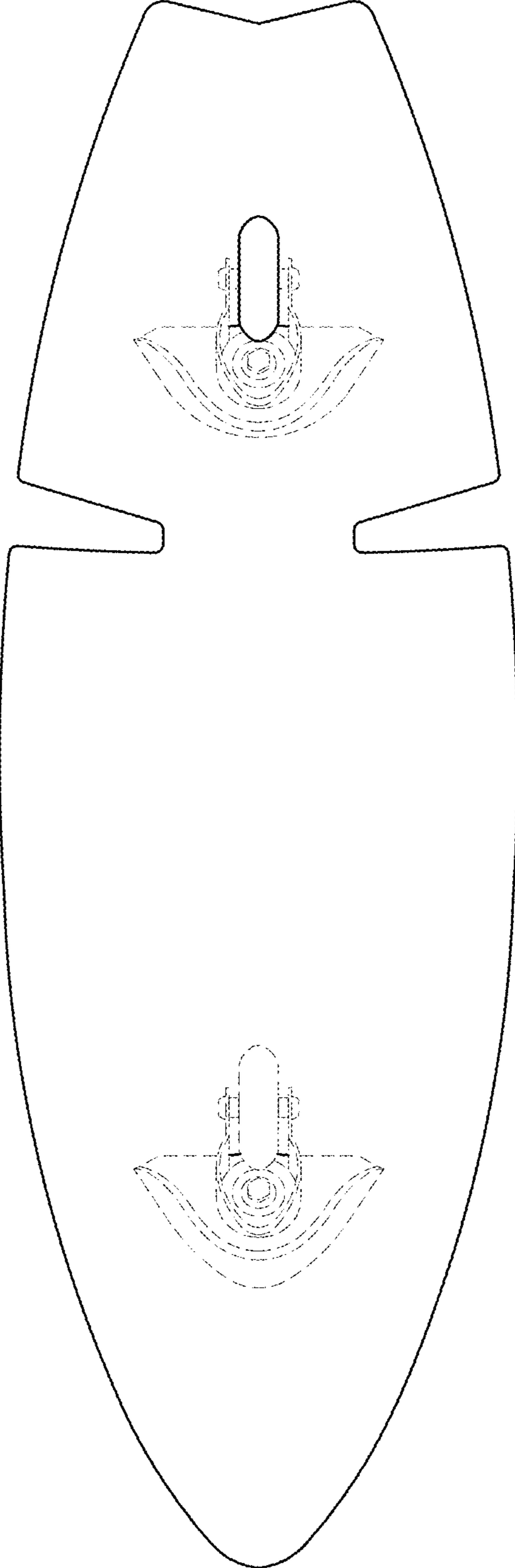

*FIG. 6*