



US00D827735S

(12) **United States Design Patent** (10) **Patent No.:** **US D827,735 S**
Ross (45) **Date of Patent:** **** Sep. 4, 2018**

(54) **KETTLEBELL**
(71) Applicant: **Exemplar Design, LLC**, Mason, OH (US)
(72) Inventor: **Adam L. Ross**, Mason, OH (US)
(73) Assignee: **EXEMPLAR DESIGN, LLC**, Mason, OH (US)
(**) Term: **15 Years**

D653,716 S * 2/2012 Lin D21/682
D654,971 S * 2/2012 Januszek D21/682
D664,613 S * 7/2012 Dalebout D21/682
D683,538 S * 6/2013 Kossman D21/713
D685,866 S * 7/2013 Kinsbourne D21/682
D726,842 S * 4/2015 Ross D21/680
D728,040 S * 4/2015 Peterson D21/680
2006/0035767 A1* 2/2006 Ekhaus A63B 21/0601
482/108
2007/0135274 A1* 6/2007 Blateri A63B 21/075
482/109

(Continued)

(21) Appl. No.: **29/590,275**
(22) Filed: **Jan. 9, 2017**
(51) **LOC (11) Cl.** **21-02**
(52) **U.S. Cl.**
USPC **D21/682**
(58) **Field of Classification Search**
USPC D21/680, 681, 682, 662, 679, 694, 678,
D21/798, 787, 684, 713, 671, 692;
482/93, 108, 107, 106, 109, 44, 47, 50,
482/98, 92, 141, 45, 110, 94; D11/81;
D30/160; D9/533, 535, 532, 668, 575;
473/596
CPC A63B 21/0728; A63B 21/075; A63B
21/00065; A63B 21/0726; A63B 21/072;
A63B 21/0724; A63B 21/063; A63B
21/4035
See application file for complete search history.

OTHER PUBLICATIONS

Bionic Body by Bionic Body dated no date given. Found online [Feb. 22, 2018] https://www.amazon.com/Bionic-Body-Kettle-Handle-Black/dp/B01MT4L92H/ref=pd_ipo_sbs_200_img_2?_encoding=UTF8&psc=1&refRID=ENV3AAG4D6KPA5T24BSE.*

(Continued)

Primary Examiner — Philip S Hyder
Assistant Examiner — Ryan Harvey
(74) *Attorney, Agent, or Firm* — Baker & Hostetler LLP

(57) **CLAIM**

I claim the ornamental design for a kettlebell, as shown and described herein.

DESCRIPTION

FIG. 1 is a top perspective view of the kettlebell showing my new design;
FIG. 2 is a front side elevation view thereof;
FIG. 3 is a back side elevation view thereof;
FIG. 4 is a left side elevation view thereof;
FIG. 5 is a right side elevation view thereof;
FIG. 6 is a top plan view thereof; and,
FIG. 7 is a bottom plan view thereof.
The broken line showing of portions of the kettlebell depicts environment and forms no part of the claim.

1 Claim, 7 Drawing Sheets

(56) **References Cited**
U.S. PATENT DOCUMENTS
5,735,776 A * 4/1998 Swezey A63B 21/0085
473/596
D522,594 S * 6/2006 Donahue D21/682
D522,595 S * 6/2006 Donahue D21/682
7,563,208 B1 * 7/2009 Chen A63B 21/0728
482/108
7,762,933 B1 * 7/2010 Yu A63B 21/075
482/106
D652,877 S * 1/2012 Dalebout D21/682

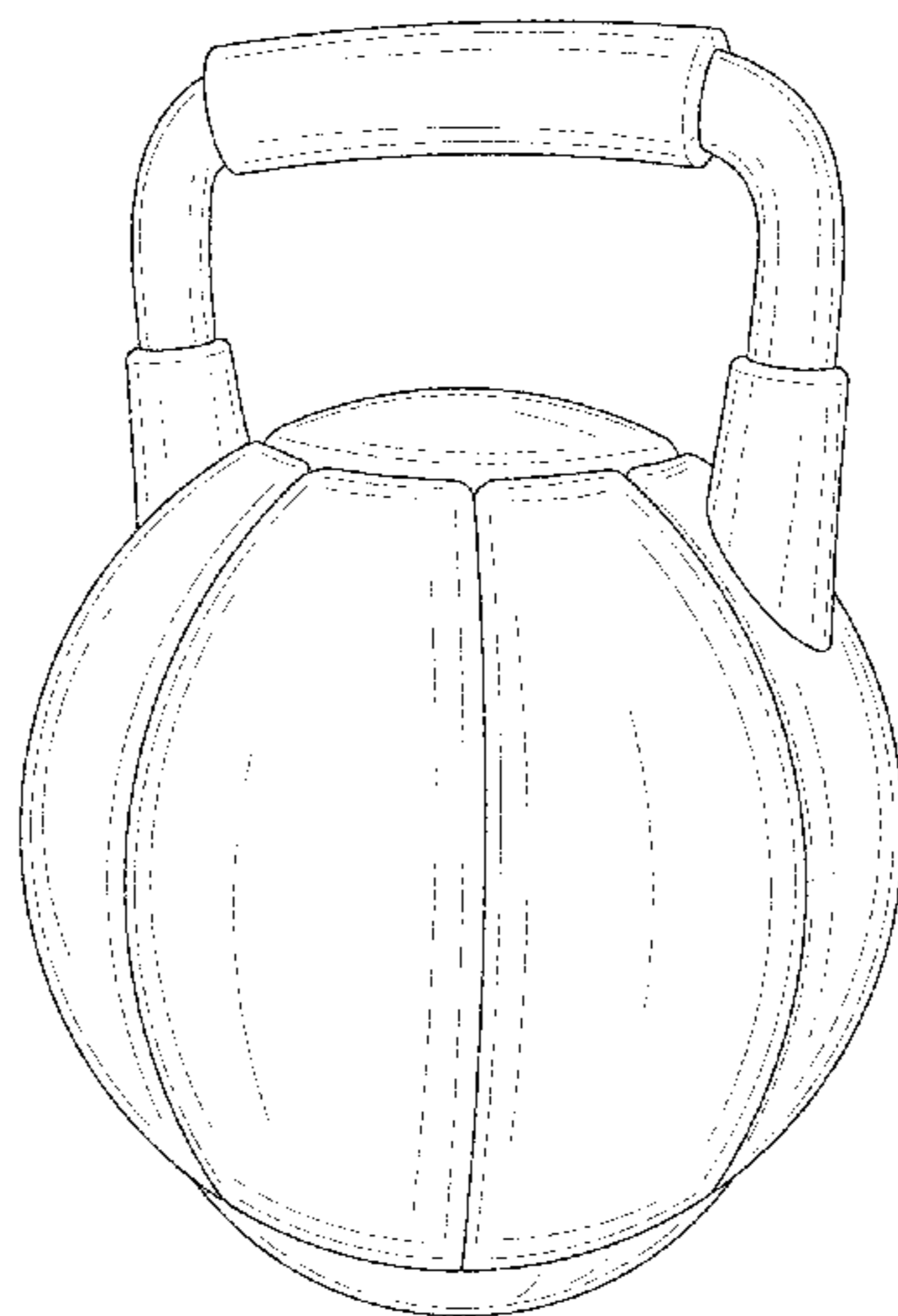

(56)

References Cited

U.S. PATENT DOCUMENTS

2011/0275494 A1* 11/2011 Radi A63B 21/0602
482/93
2012/0322631 A1* 12/2012 Januszek A63B 21/072
482/108
2013/0040789 A1* 2/2013 Kessler A63B 21/072
482/108

OTHER PUBLICATIONS

Valor by Valor dated no date given. Found online [Feb. 22, 2018]
[https://www.amazon.com/Valor-Fitness-Soft-Kettlebell/dp/
B01MQIJNBK/ref=pd_Ipo_sbs_200_img_0?_encoding=UTF8
&refRID=ENV3AAG4D6KPA5T24BSE.*](https://www.amazon.com/Valor-Fitness-Soft-Kettlebell/dp/B01MQIJNBK/ref=pd_Ipo_sbs_200_img_0?_encoding=UTF8&refRID=ENV3AAG4D6KPA5T24BSE.*)
Fuji by Fuji dated. Found online Feb. 6, 2018 [Feb. 22, 2018]
[https://www.amazon.com/Fuji-FF2000A-20-Parent-FUJIFit-Soft-
Kettlebell/dp/B01M9GBC69.*](https://www.amazon.com/Fuji-FF2000A-20-Parent-FUJIFit-Soft-Kettlebell/dp/B01M9GBC69.*)

* cited by examiner

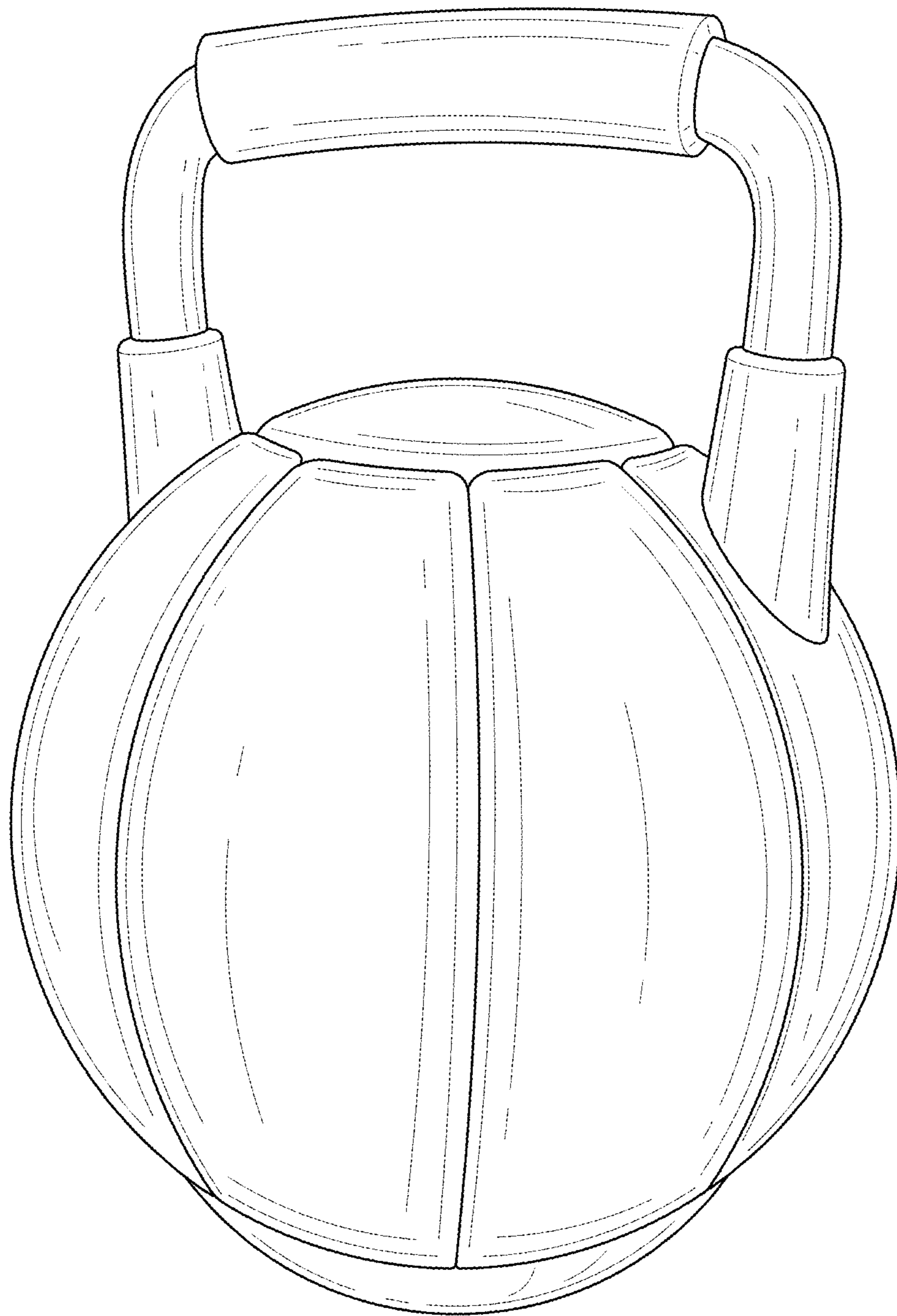

FIG. 1

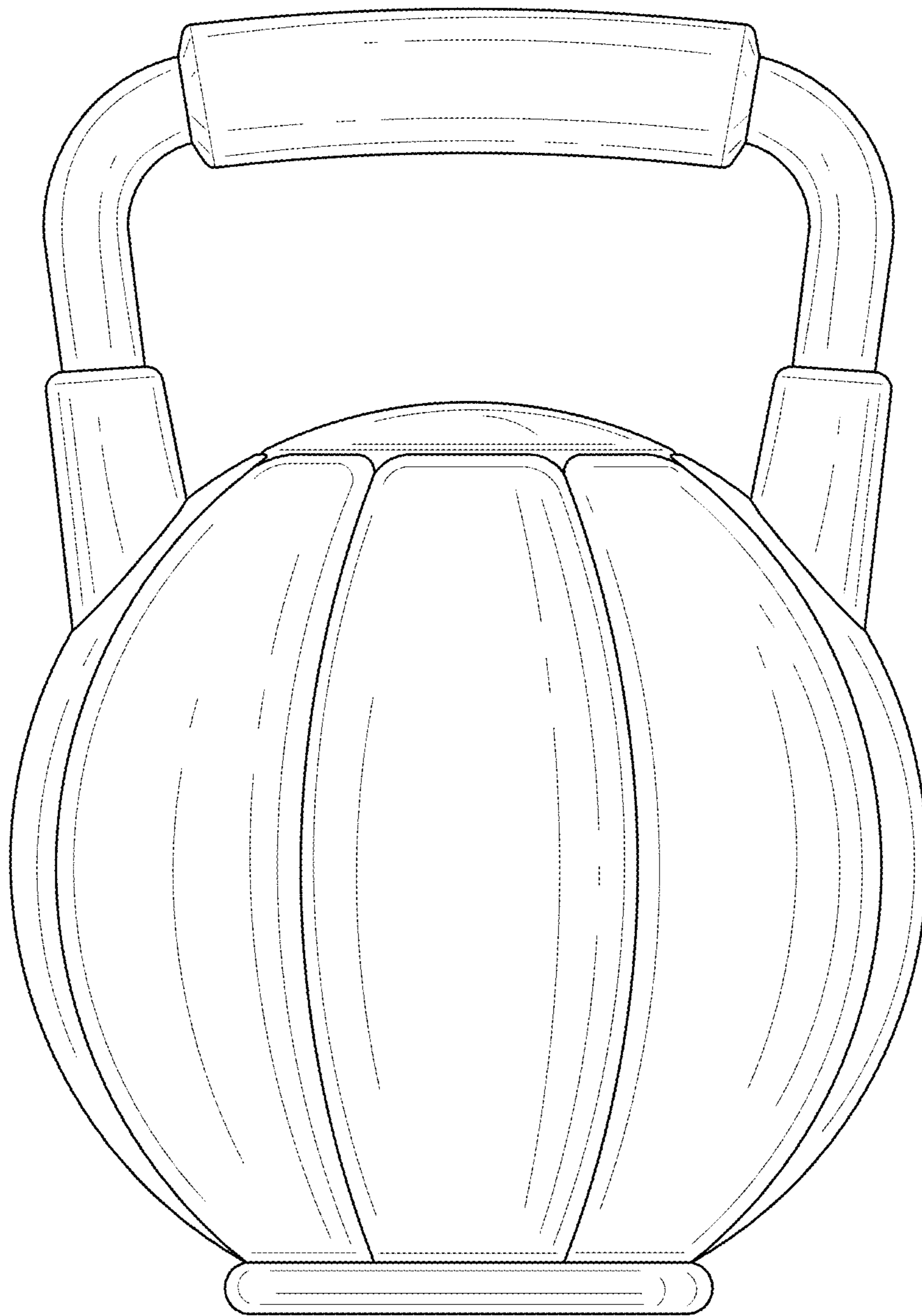

FIG. 2

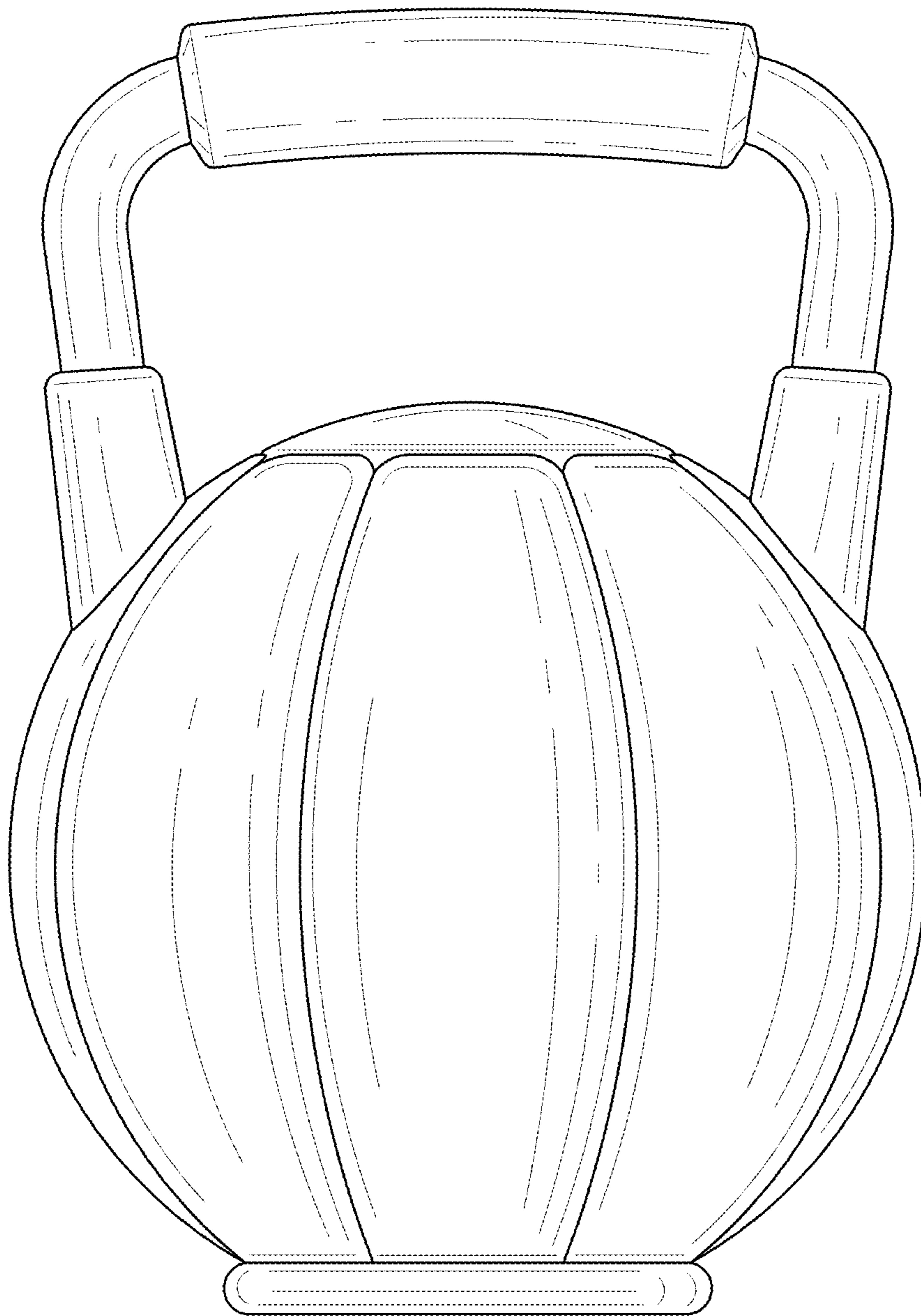

FIG. 3

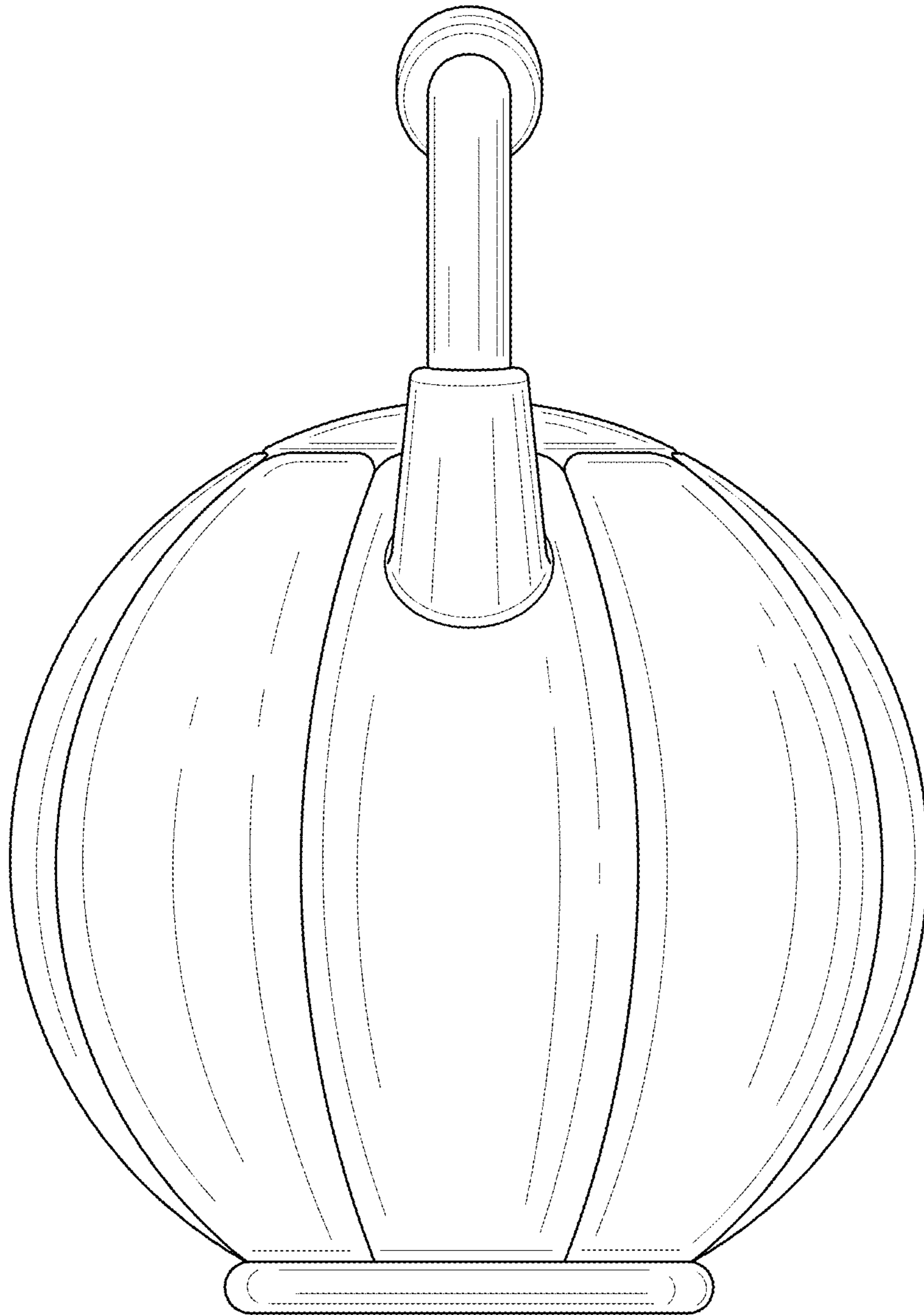

FIG. 4

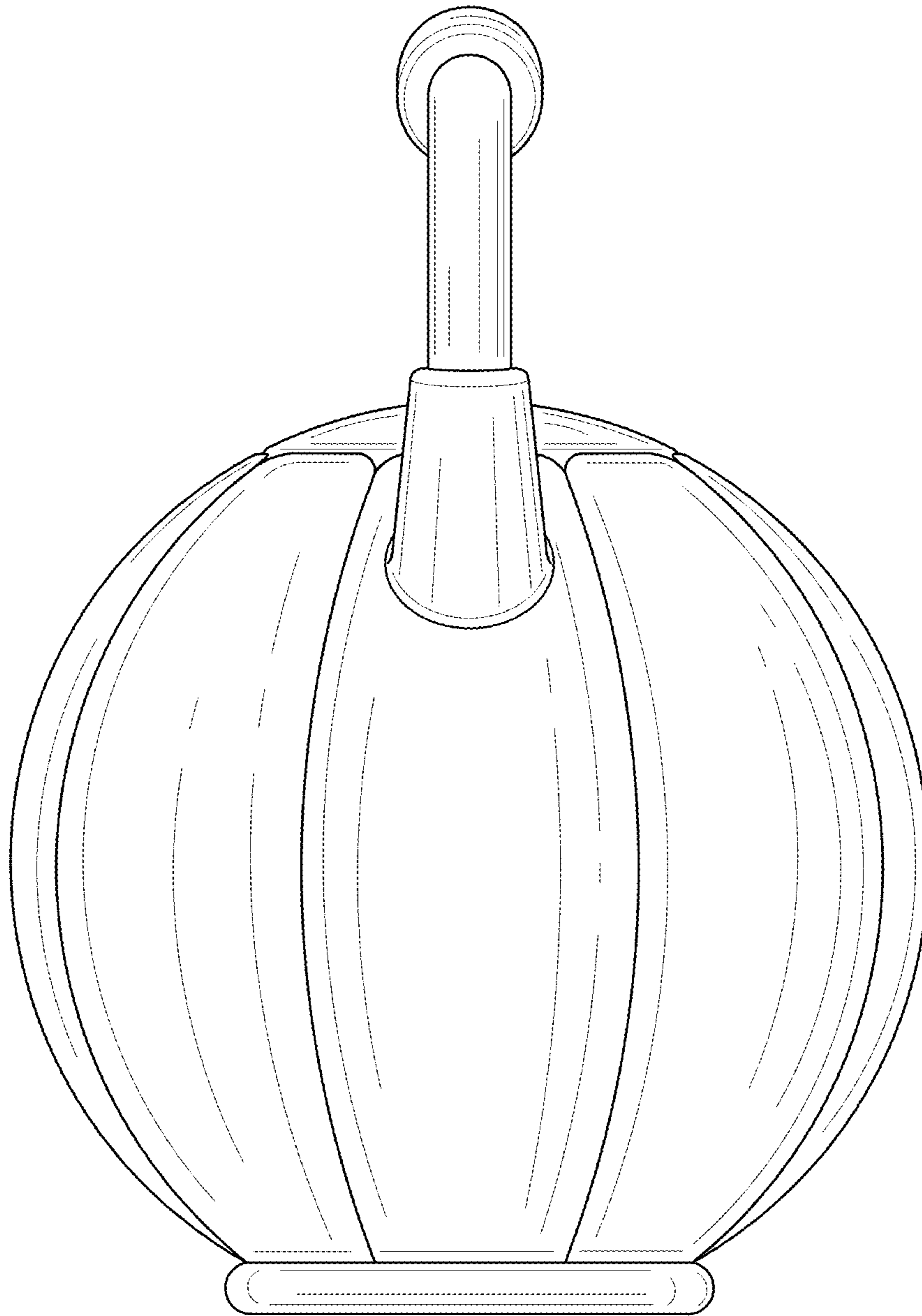

FIG. 5

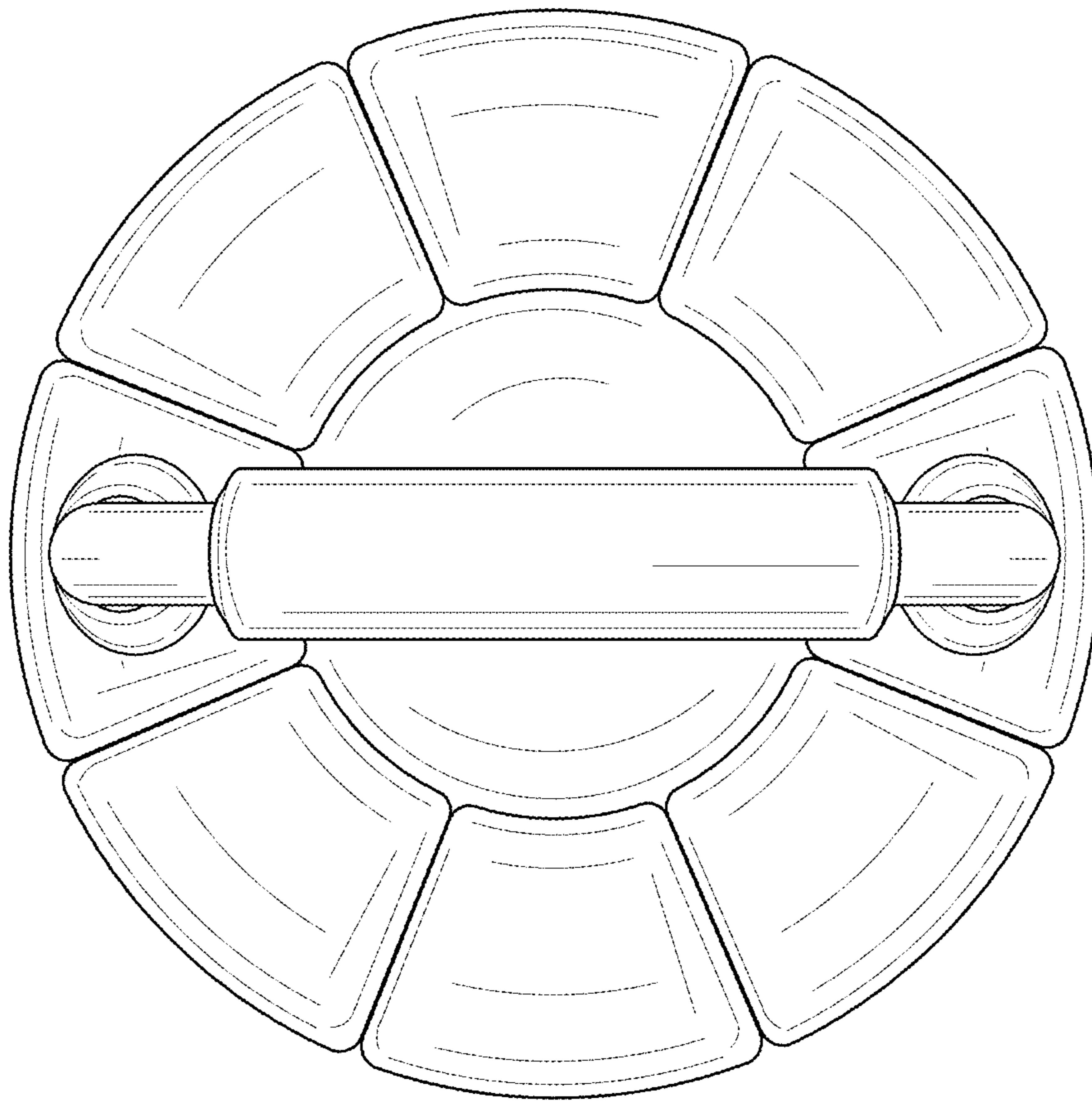

FIG. 6

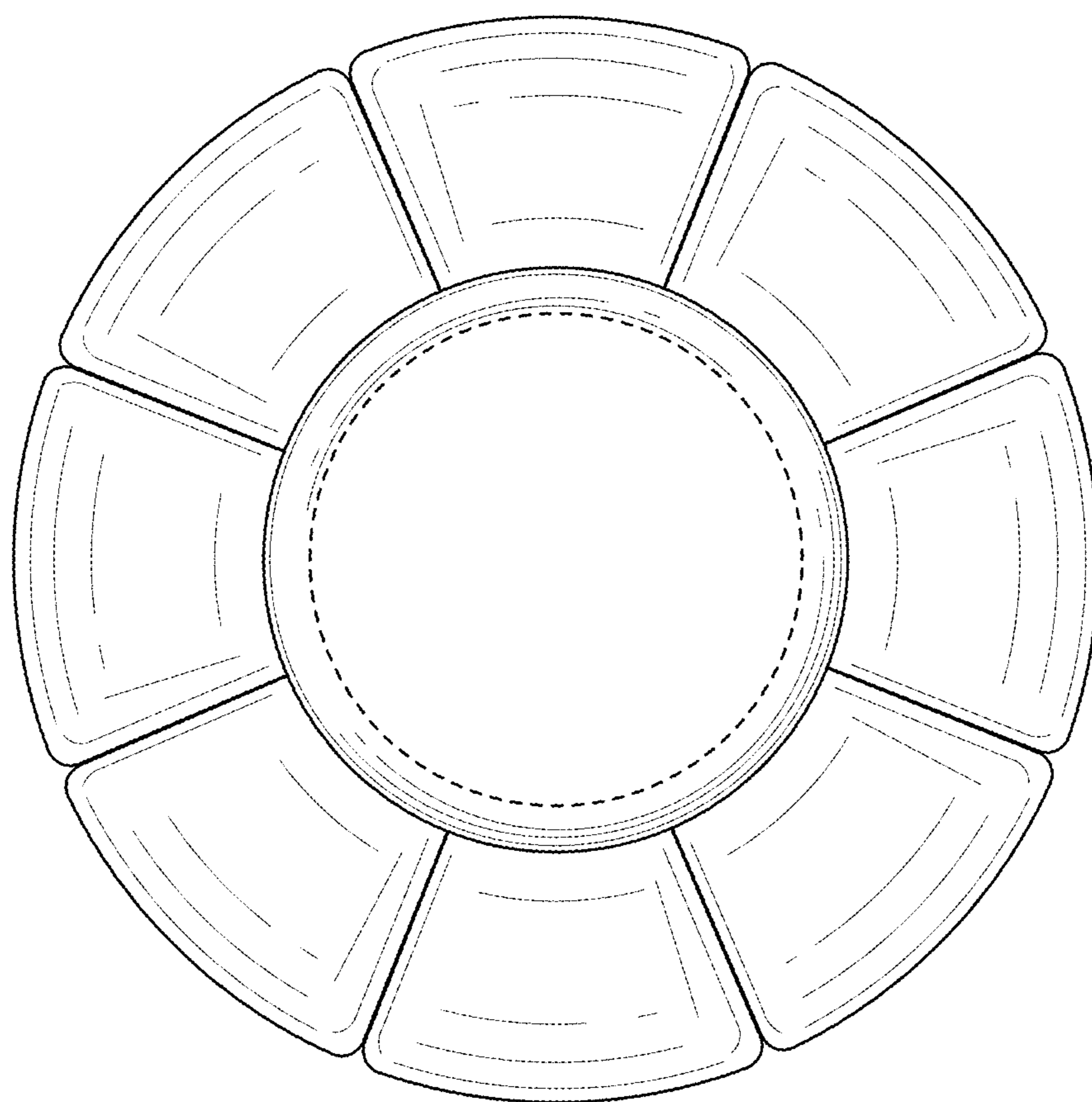

FIG. 7