



US00D827700S

(12) **United States Design Patent**  
**Ganovsky et al.**

(10) **Patent No.:** **US D827,700 S**  
(45) **Date of Patent:** **\*\* Sep. 4, 2018**

(54) **GLASSES WITH FOLDABLE ARMS**

(71) Applicant: **Neckglasses, LLC**, Oxford, MS (US)

(72) Inventors: **Karen June Ganovsky**, Windermere, FL (US); **Peng Lee**, Oxford, MS (US); **Dianna Varner Seddon**, Oxford, MS (US)

(73) Assignee: **NeckGlasses, LLC**, Oxford, MS (US)

(\*\*) Term: **15 Years**

(21) Appl. No.: **29/600,795**

(22) Filed: **Apr. 14, 2017**

(51) **LOC (11) Cl.** ..... **16-06**

(52) **U.S. Cl.**  
USPC ..... **D16/303; D16/315**

(58) **Field of Classification Search**  
USPC ..... **D16/100-101, 300-342**  
CPC . **G02C 5/20; G02C 5/22; G02C 5/006; G02C 5/00; G02C 1/06; G02C 1/08; G02C 5/02**  
See application file for complete search history.

(56) **References Cited**

**U.S. PATENT DOCUMENTS**

1,031,298	A *	7/1912	Spaney et al. ....	G02C 3/04 351/51
4,887,895	A *	12/1989	Tzeng .....	G02C 5/08 351/44
5,028,126	A *	7/1991	Takeuchi .....	G02C 5/08 351/153
5,896,185	A *	4/1999	Huang .....	G02C 5/006 2/454

(Continued)

**OTHER PUBLICATIONS**

Agstum Mens Womens Half Moon Foldable Reading Glasses with Case, date first listed Oct. 17, 2017, <<https://www.amazon.com/Agstum-Womens-Foldable-Reading-Glasses/dp/B076HT6V8X?SubscriptionId=AKIAJTAQJFXQ45MML2MA>>

&tag=bogomash-20&linkCode=xm2&camp=2025  
&creative=165953&creativeASIN=B076HT6V8X>.\*

*Primary Examiner* — Cathron C Brooks

*Assistant Examiner* — Sharon S Oum

(74) *Attorney, Agent, or Firm* — Veritay Group, IP; Susan Fentress

(57) **CLAIM**

The ornamental design for glasses with foldable arms, as shown and described.

**DESCRIPTION**

FIG. 1 is an isometric front view of glasses with foldable arms showing our new design;  
FIG. 2 is an isometric rear view thereof;  
FIG. 3 is a front view thereof;  
FIG. 4 is a right side view thereof;  
FIG. 5 is a rear view thereof;  
FIG. 6 is a left side view thereof;  
FIG. 7 is a top view thereof;  
FIG. 8 is a bottom view thereof;  
FIG. 9 is an isometric front view of FIG. 1, but shown in an unfolded position;  
FIG. 10 is an isometric rear view thereof;  
FIG. 11 is a front view thereof;  
FIG. 12 is a right side view thereof;  
FIG. 13 is a rear view thereof;  
FIG. 14 is a left side view thereof;  
FIG. 15 is a top view thereof;  
FIG. 16 is a bottom view thereof;  
FIG. 17 is an isometric view of FIG. 1, shown with the arms in a first folded position;  
FIG. 18 is an isometric view of FIG. 1, shown with the arms in a second folded position;  
FIG. 19 is an isometric view of FIG. 1, shown with the arms in a third folded position;  
FIG. 20 is an isometric view of FIG. 1, shown with the arms in a fourth folded position; and,  
FIG. 21 is an isometric view of FIG. 1, shown with the arms in a fifth folded position.

**1 Claim, 16 Drawing Sheets**

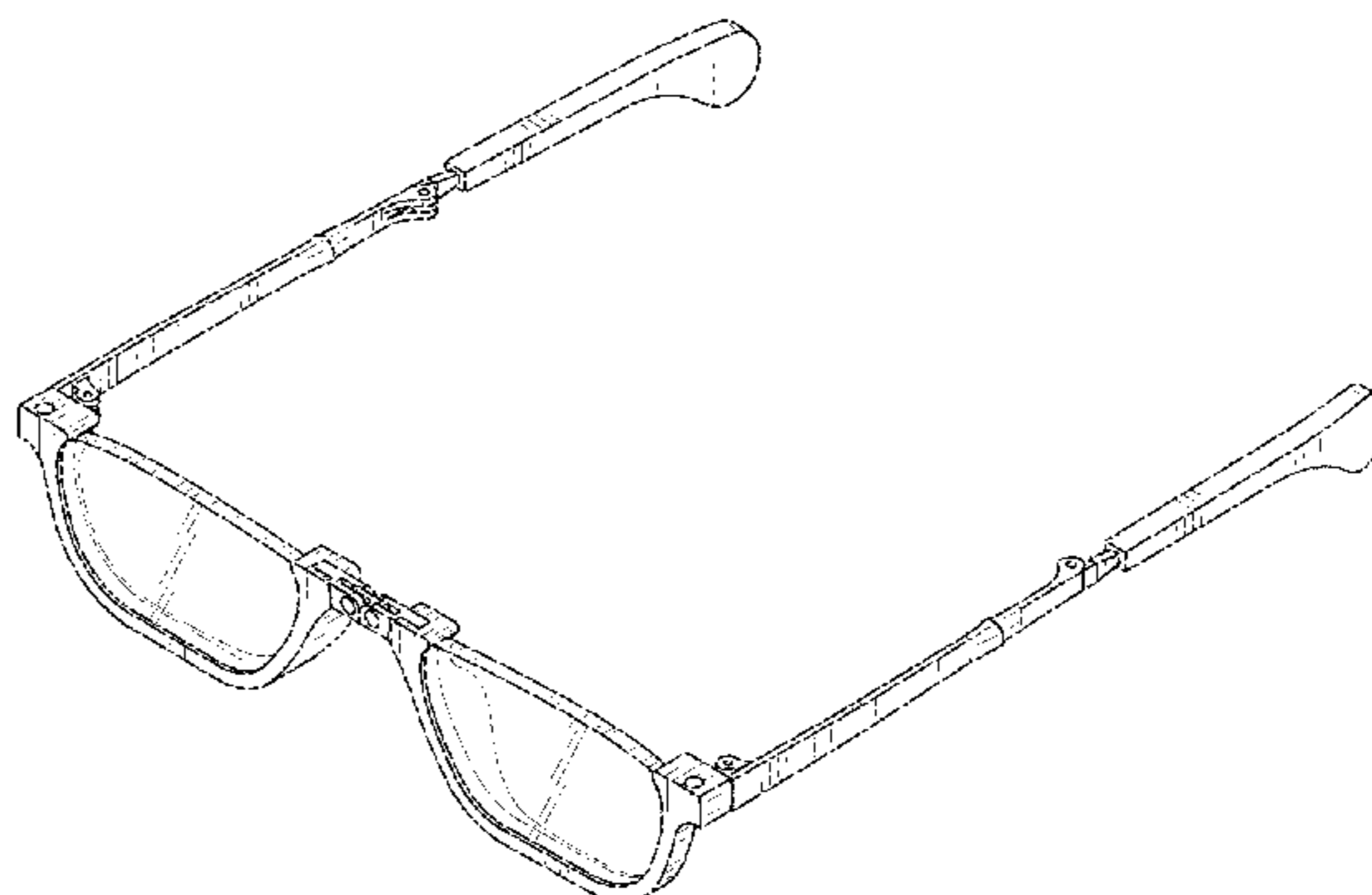
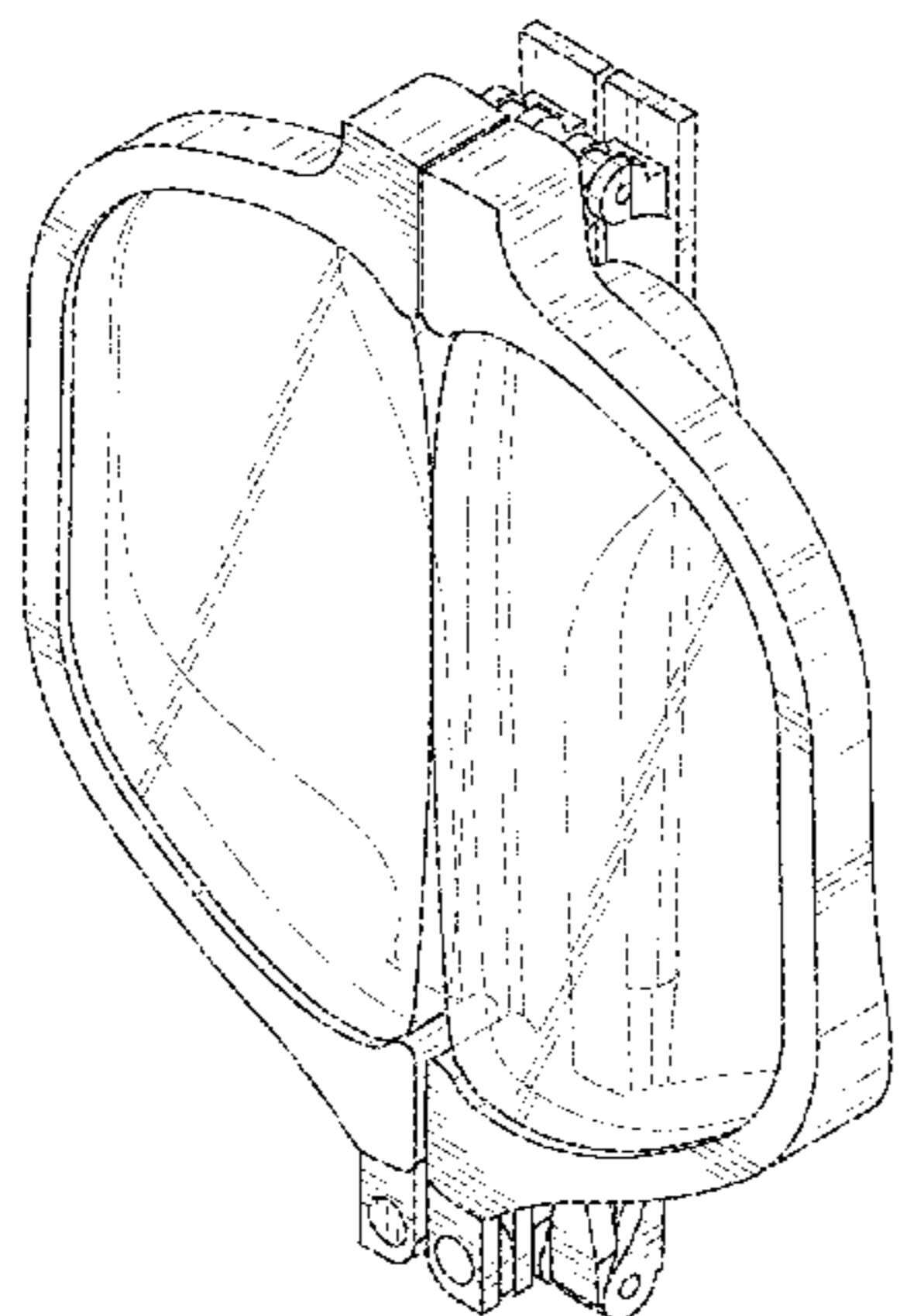

(56)

**References Cited**

## U.S. PATENT DOCUMENTS

6,048,061 A \* 4/2000 Chiu ..... G02C 3/003  
351/41  
6,158,860 A \* 12/2000 Huang ..... G02C 5/006  
351/136  
6,494,573 B1 \* 12/2002 Huang ..... G02C 5/006  
2/454  
8,132,908 B2 \* 3/2012 Cargnel ..... G02C 5/08  
351/119  
8,317,317 B2 \* 11/2012 Pulvino ..... G02C 3/003  
351/112  
D693,398 S \* 11/2013 Rubin ..... D16/303  
D702,281 S \* 4/2014 Szymanski ..... D16/303  
D703,725 S \* 4/2014 Keller ..... D16/303  
D704,763 S \* 5/2014 Keller ..... D16/303  
D713,444 S 9/2014 Lee et al.  
D733,210 S \* 6/2015 Keller ..... D16/303  
D745,595 S \* 12/2015 Szymanski ..... D16/303  
D750,155 S 2/2016 Ganovsky et al.  
D774,122 S 12/2016 Ganovsky et al.  
D777,825 S 1/2017 Ganovsky et al.  
D814,551 S \* 4/2018 Barrina ..... D16/303  
2009/0051868 A1 \* 2/2009 Kwan ..... G02C 5/006  
351/137  
2011/0228210 A1 \* 9/2011 Willett ..... A45C 11/04  
351/63  
2016/0025999 A1 \* 1/2016 Chen ..... G02C 5/006  
351/63  
2018/0074342 A1 \* 3/2018 Boedecker ..... G02C 5/14

\* cited by examiner

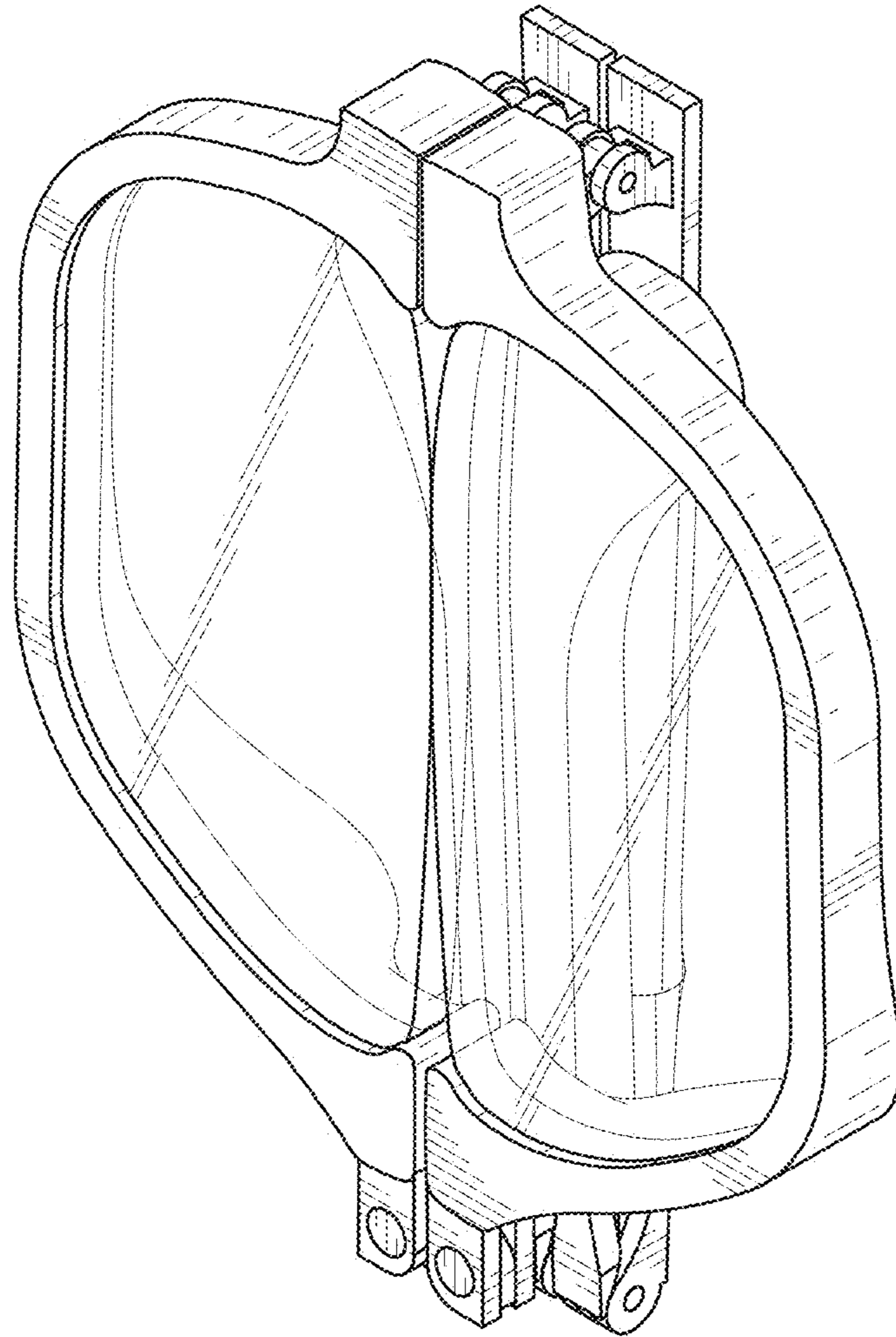

FIG. 1

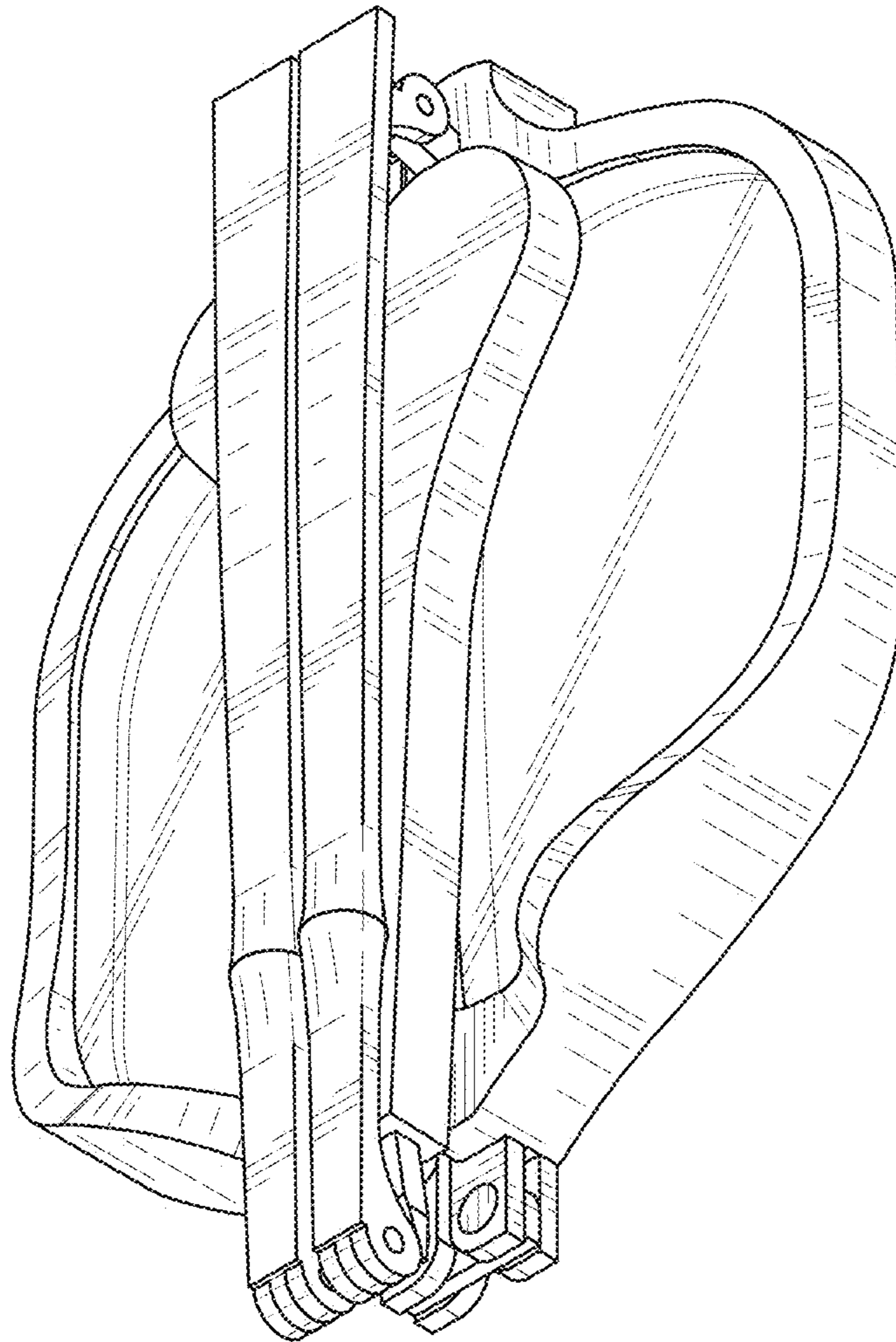

FIG. 2



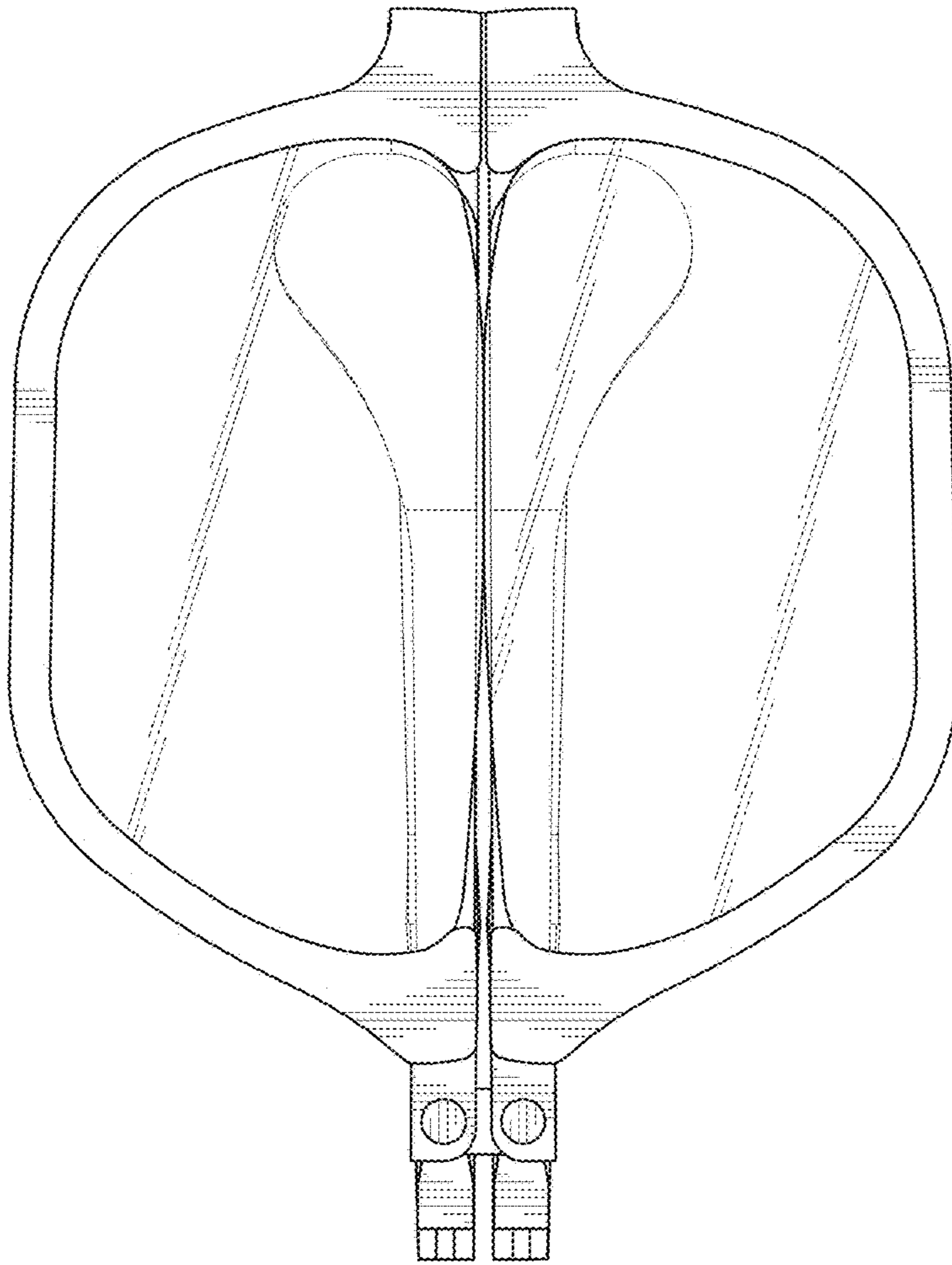

FIG. 3

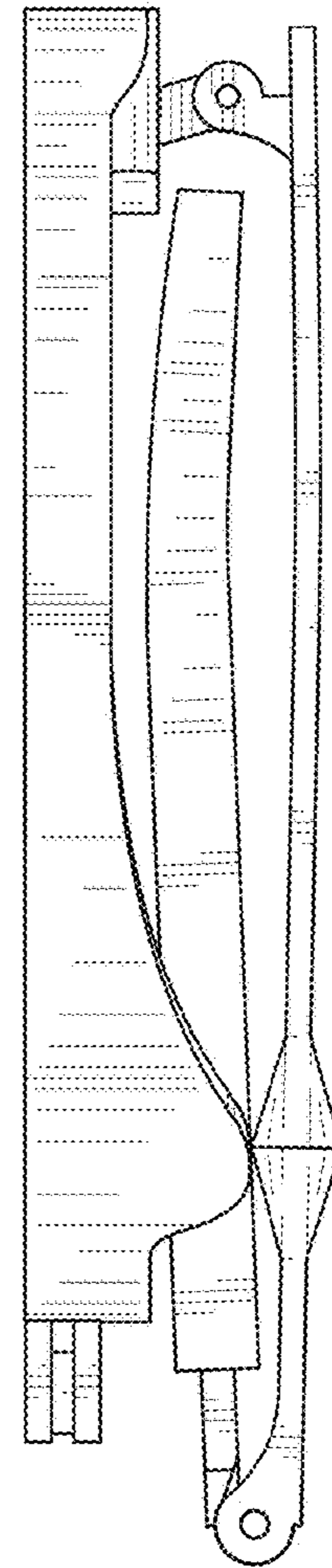

FIG. 4

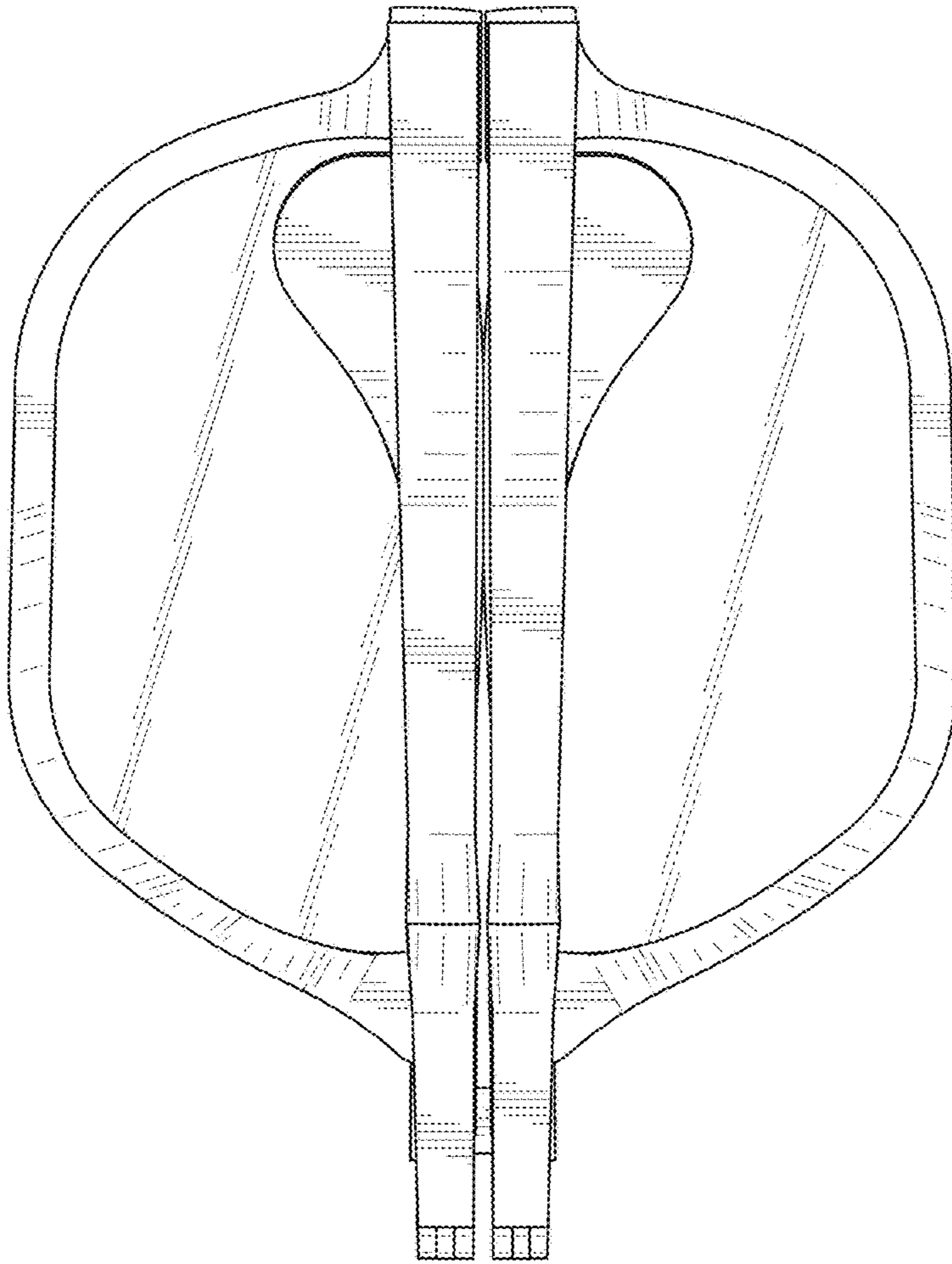

FIG. 5

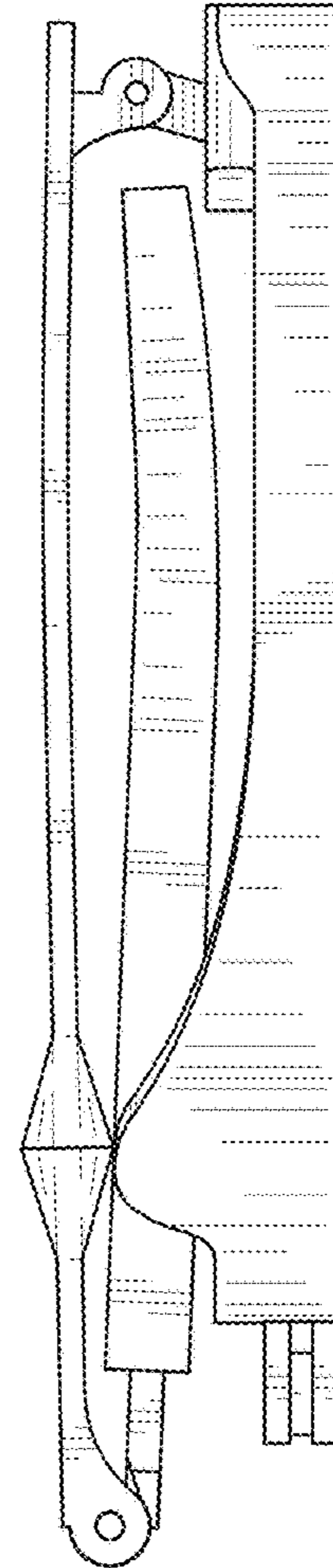

FIG. 6

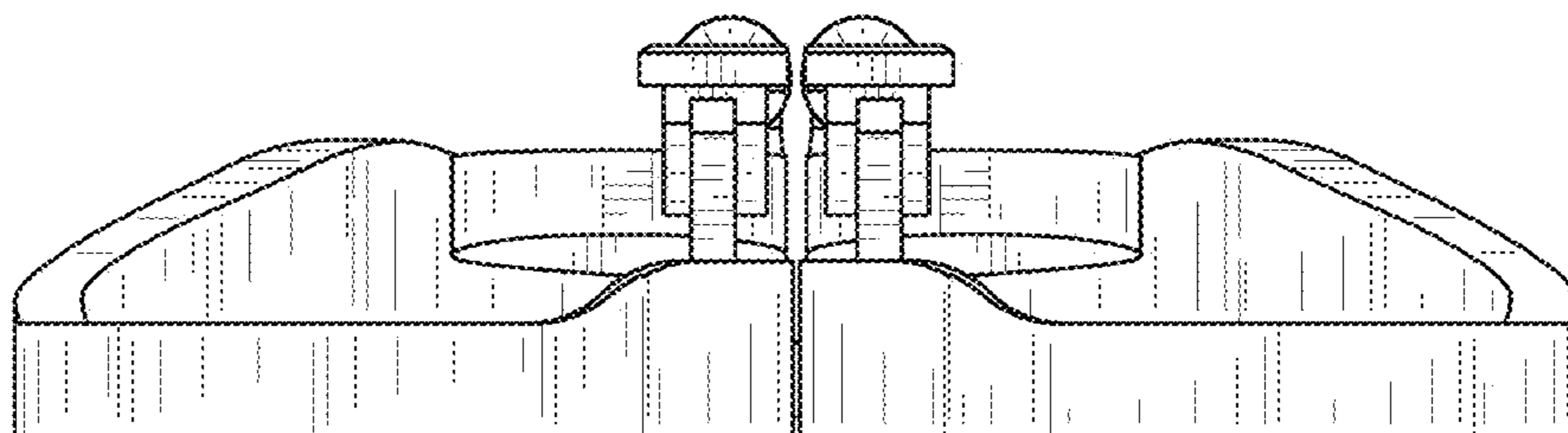

FIG. 7

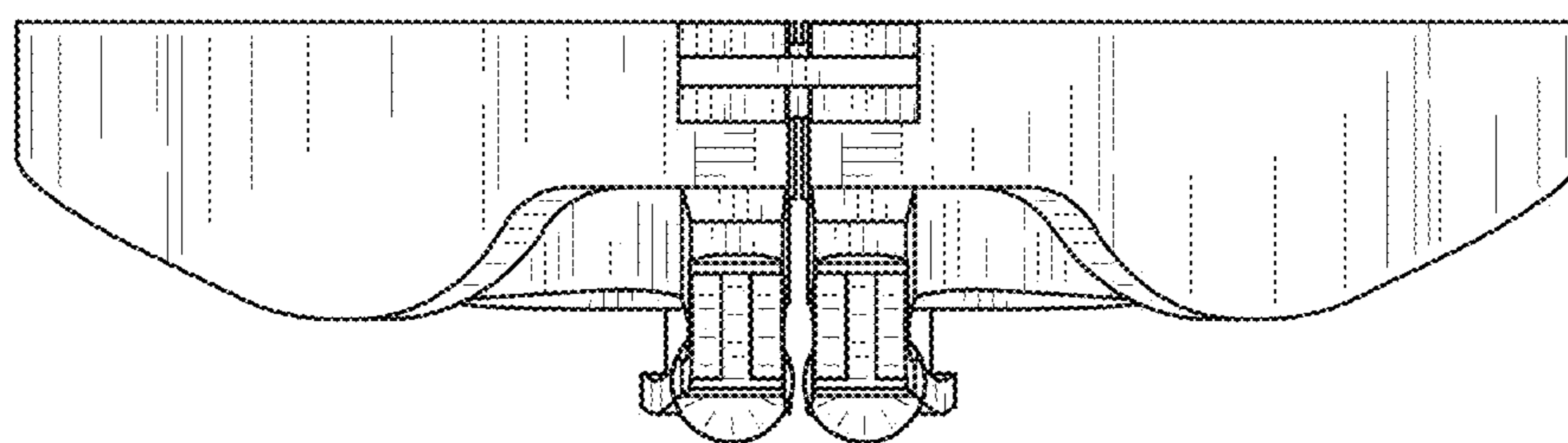

FIG. 8

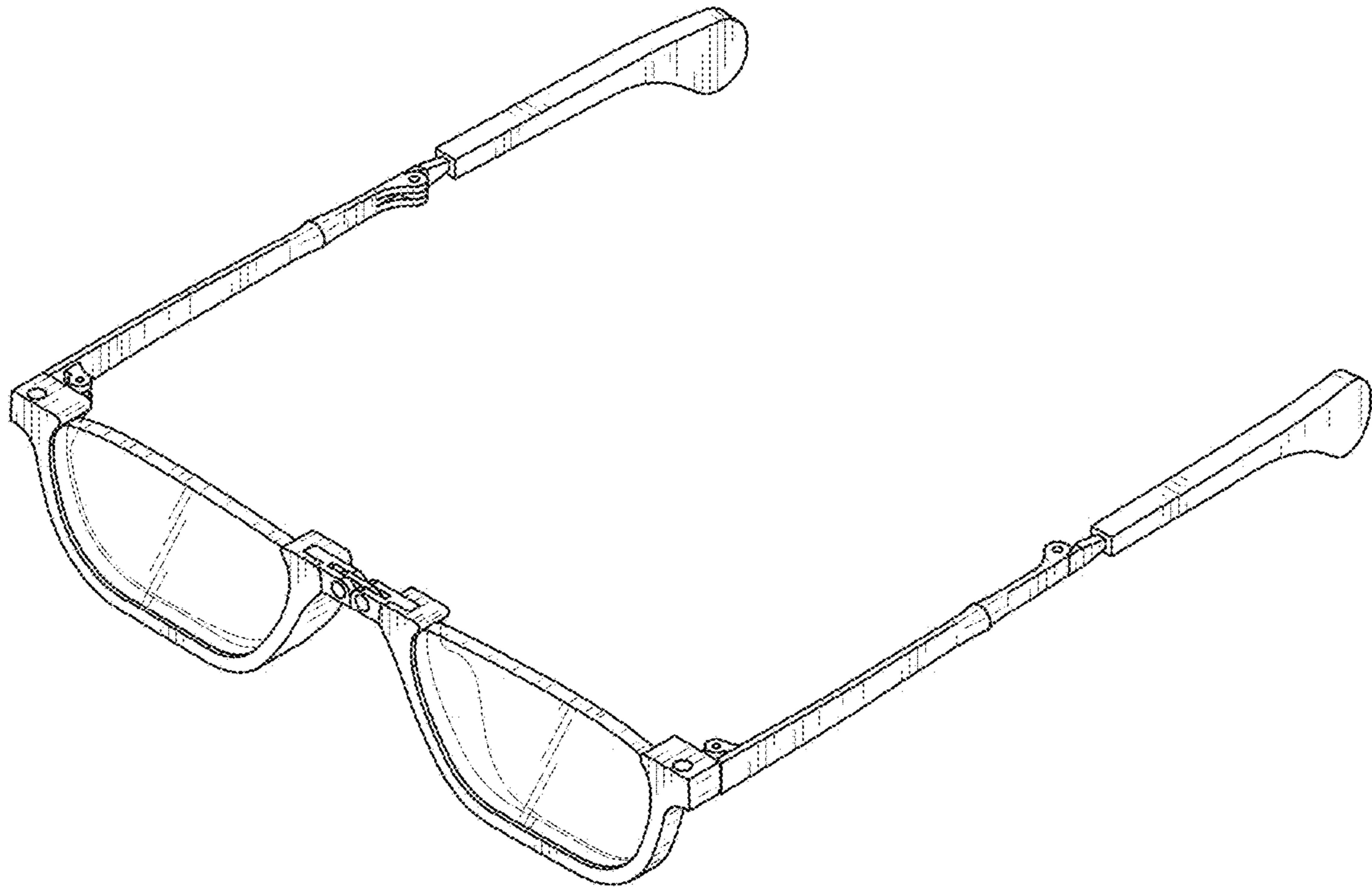

FIG. 9



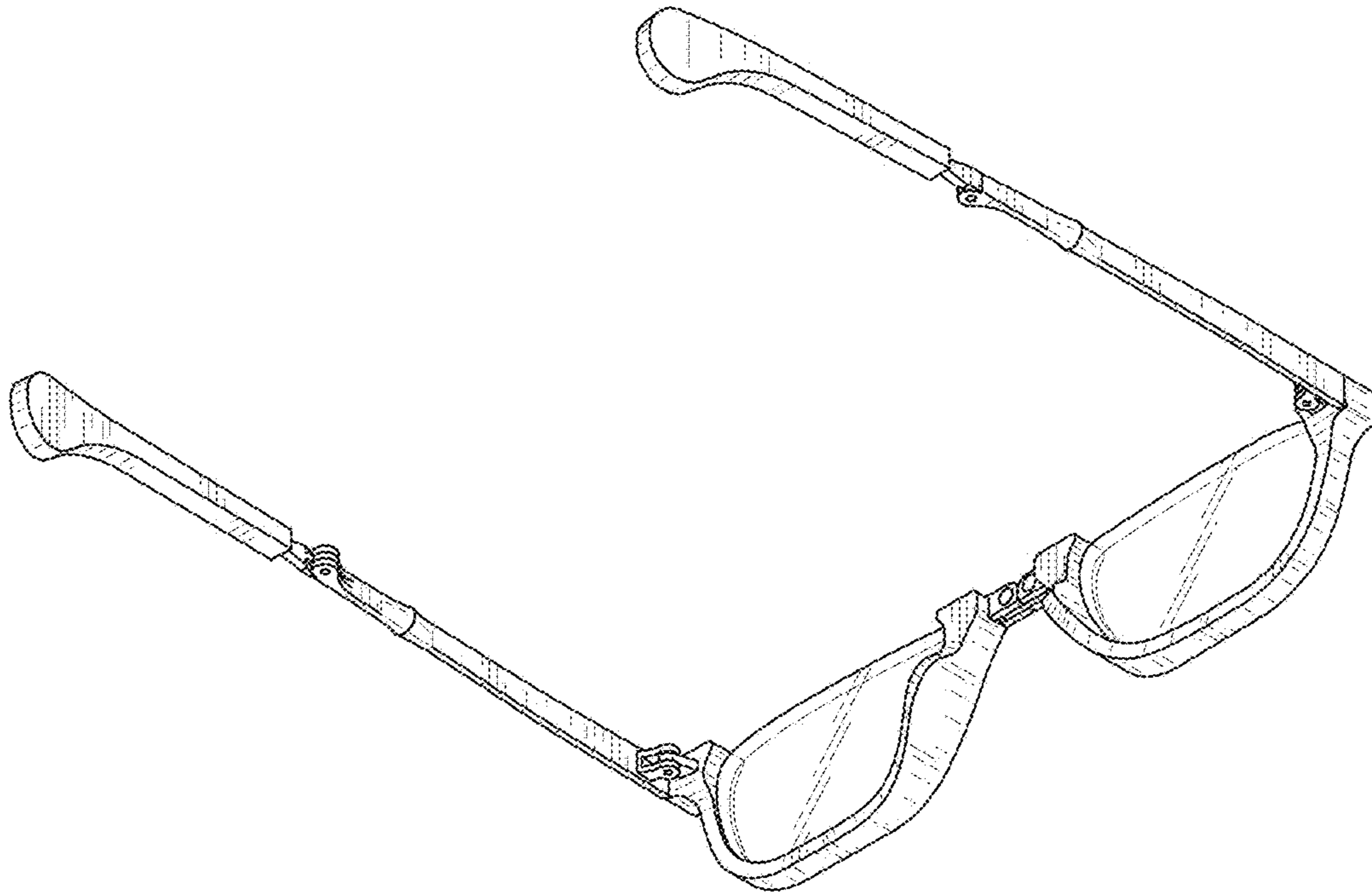

FIG. 10

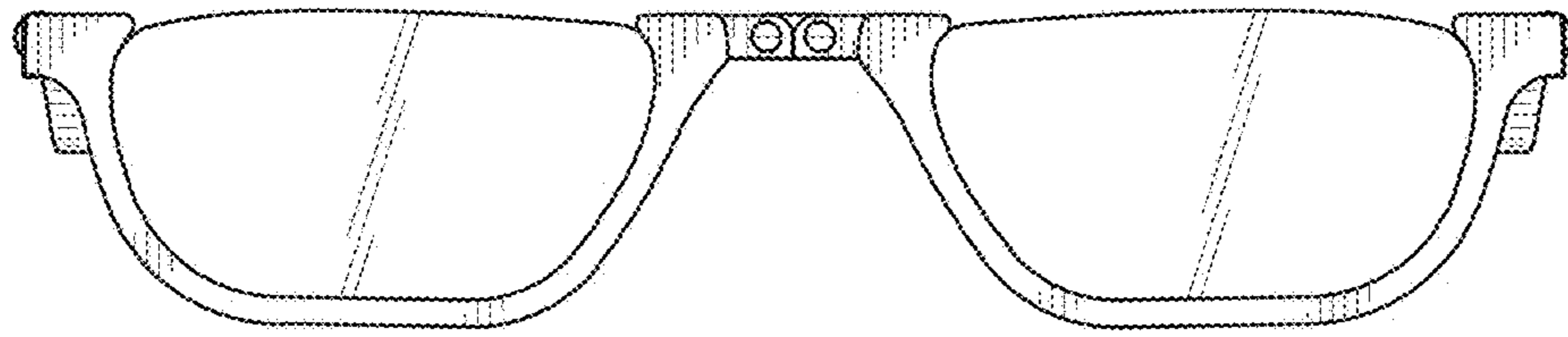

FIG. 11

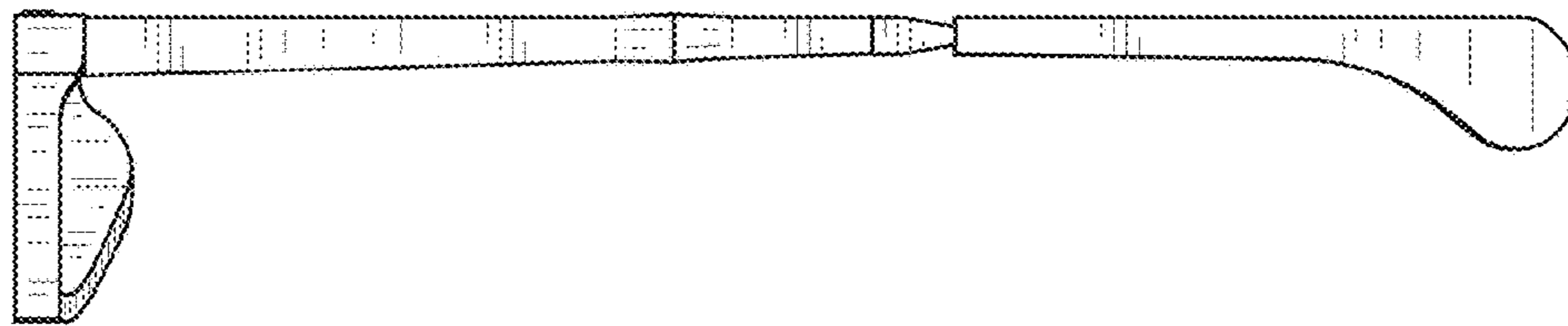

FIG. 12

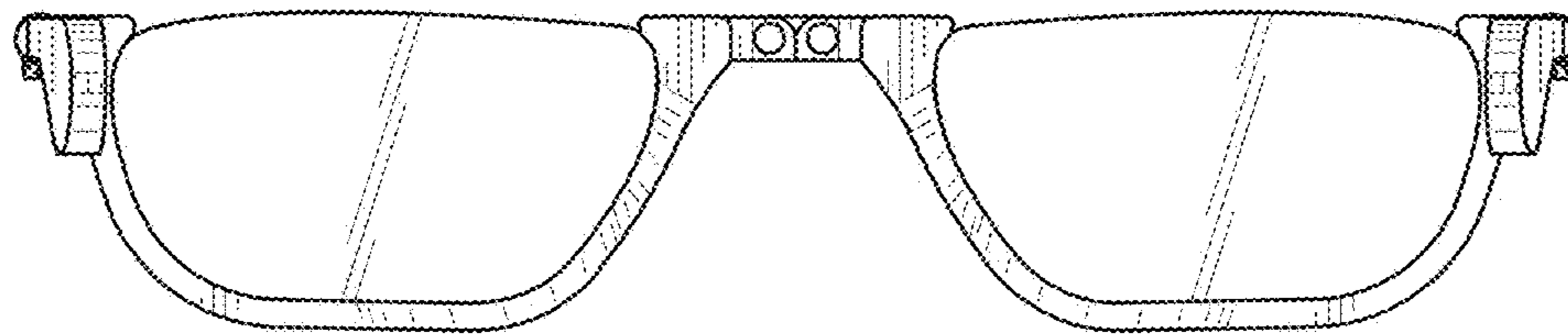

FIG. 13

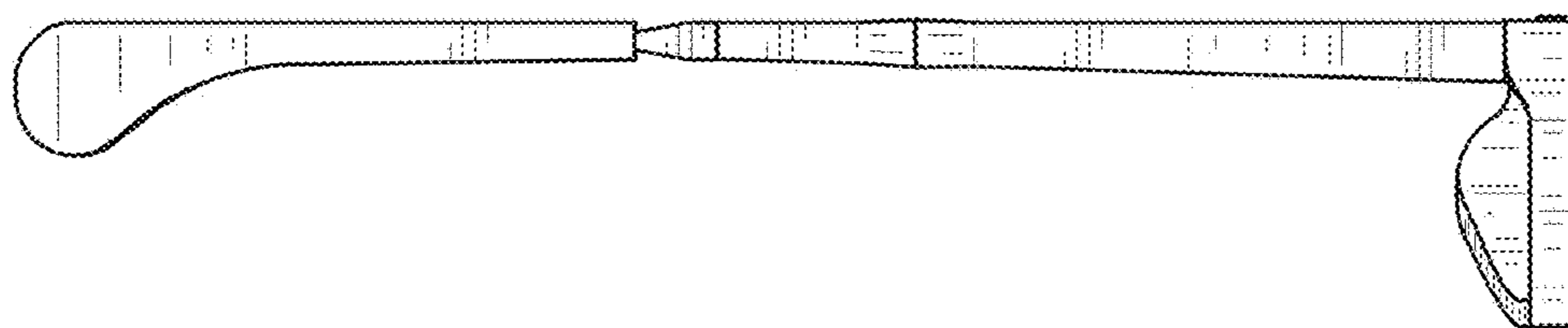

FIG. 14

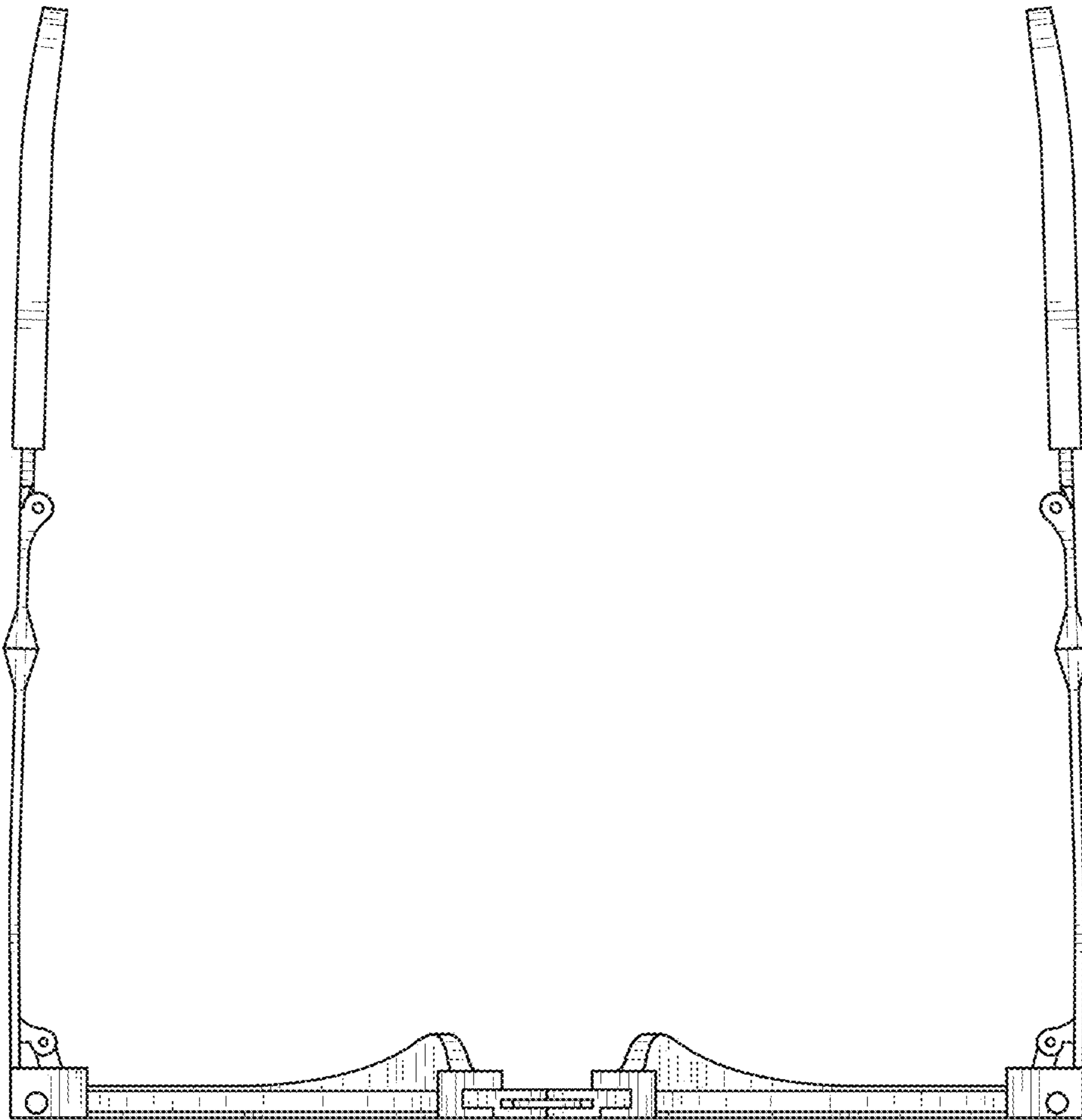

FIG. 15



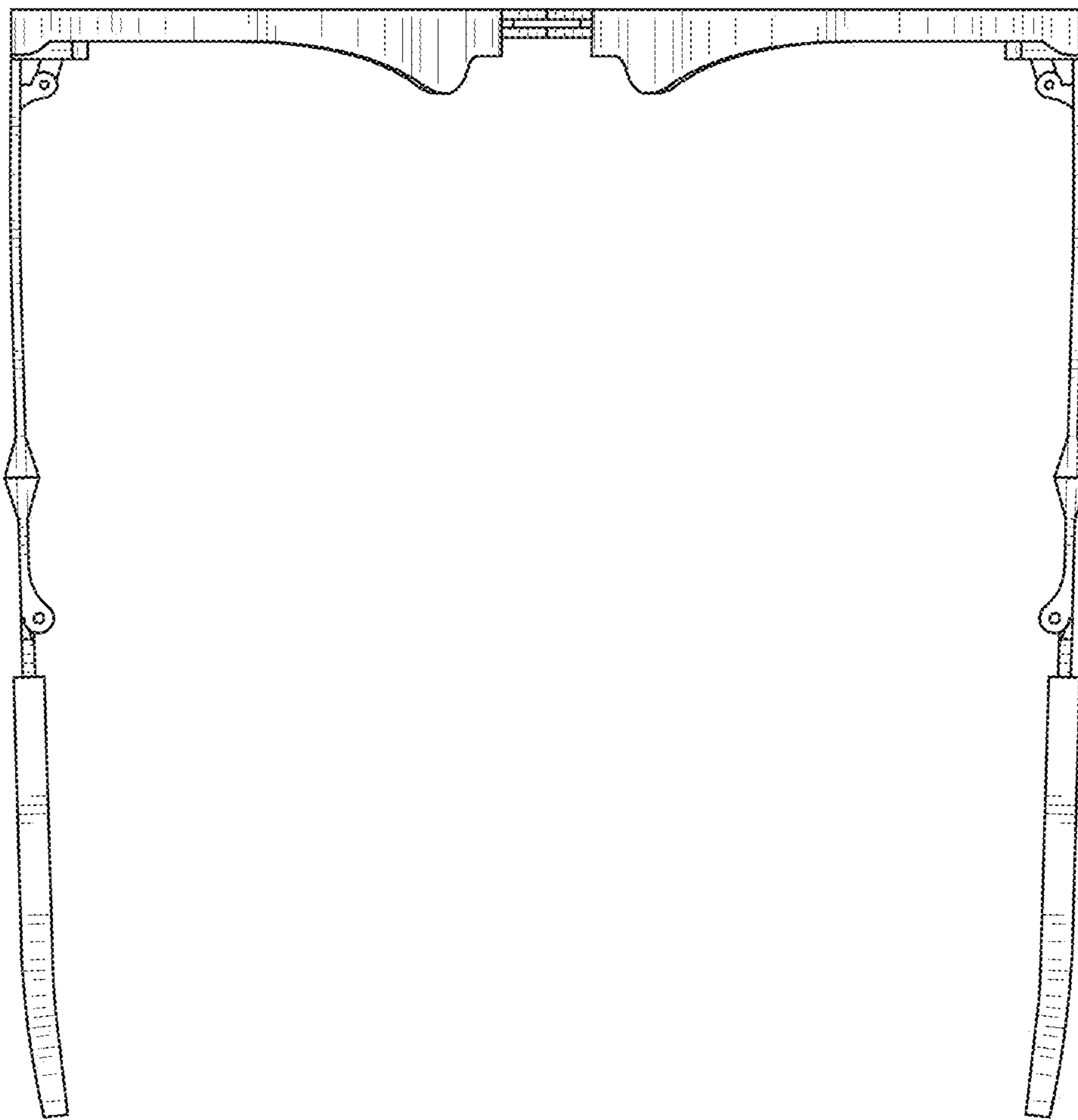

FIG. 16

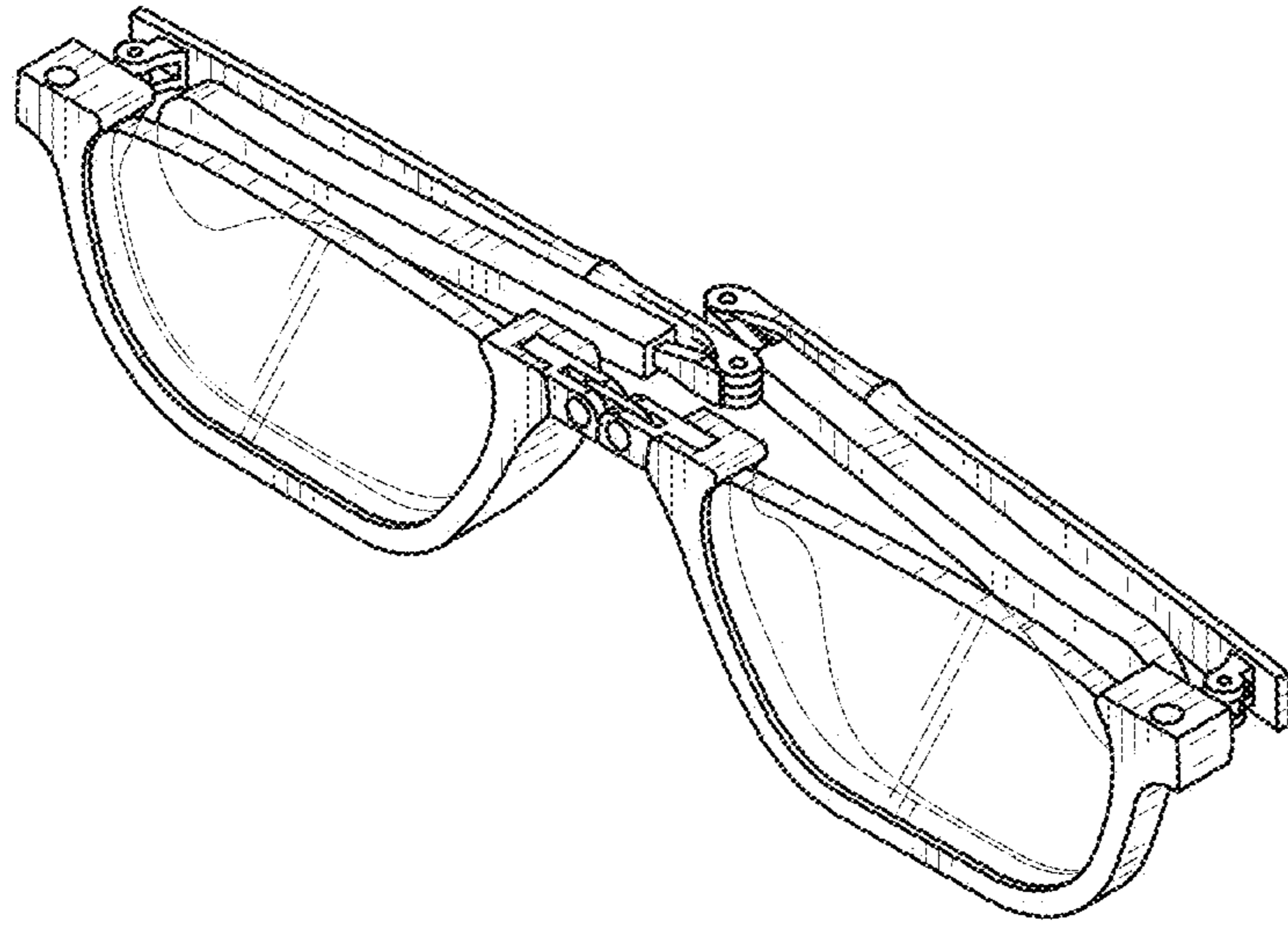

FIG. 17

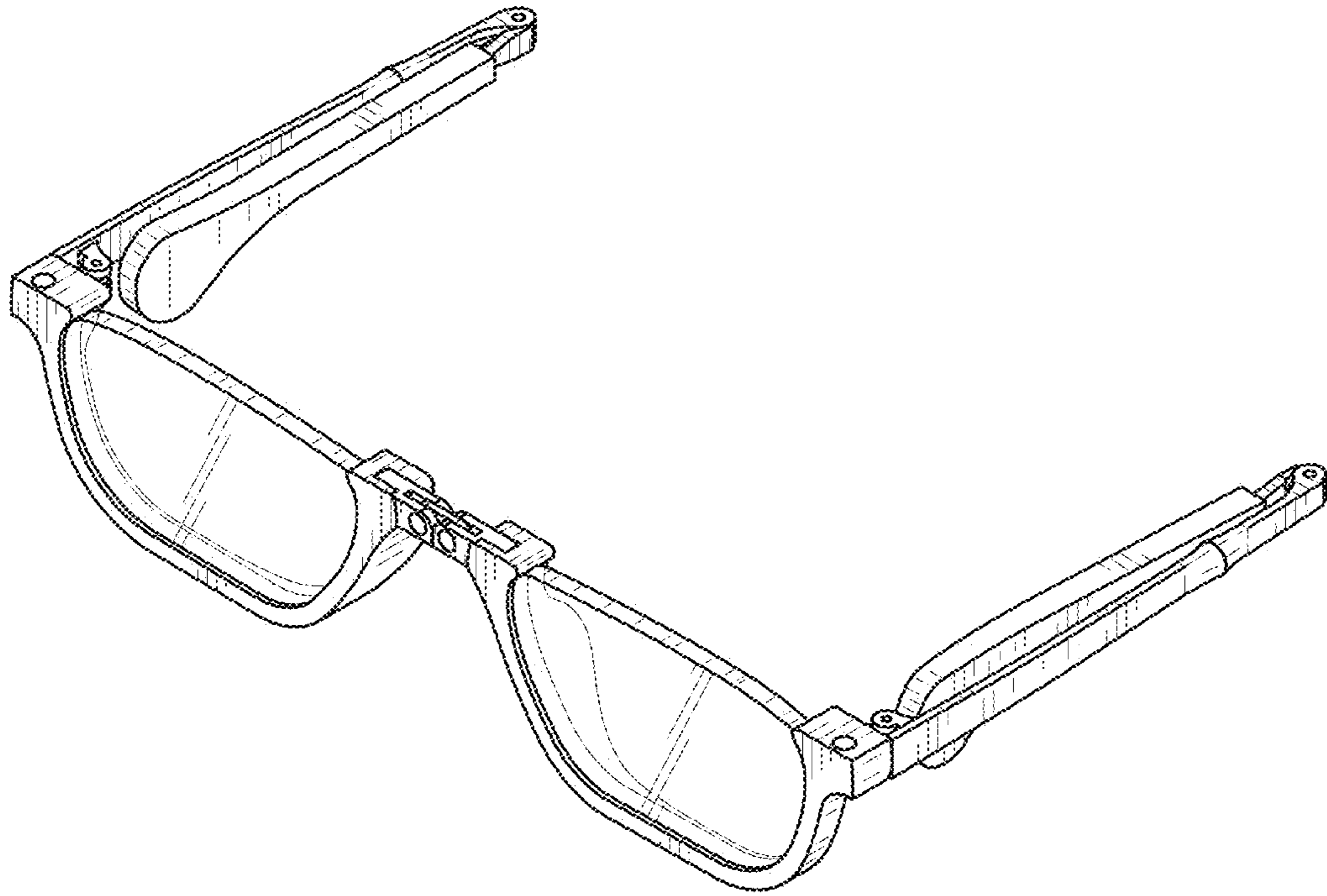

FIG. 18

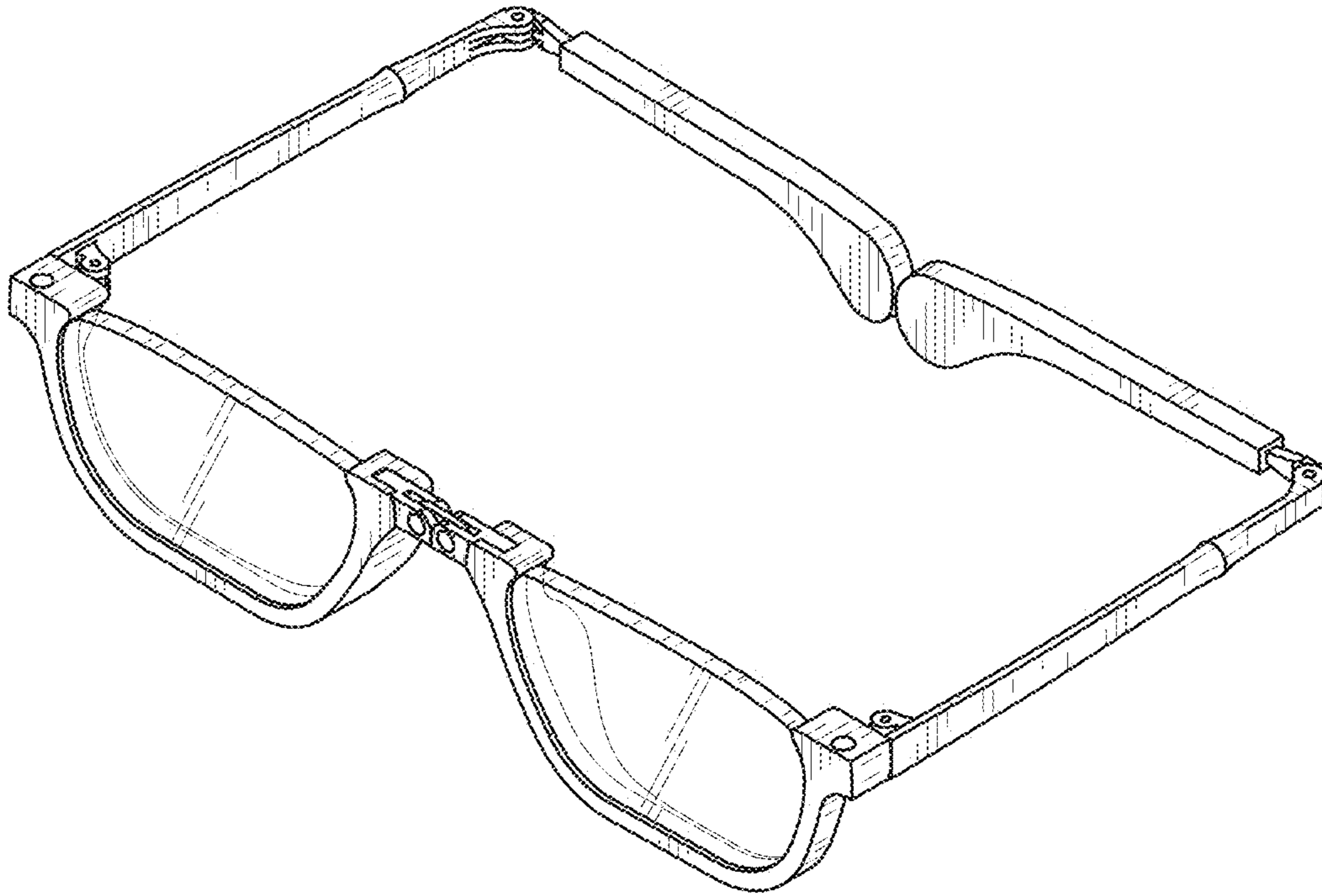

FIG. 19



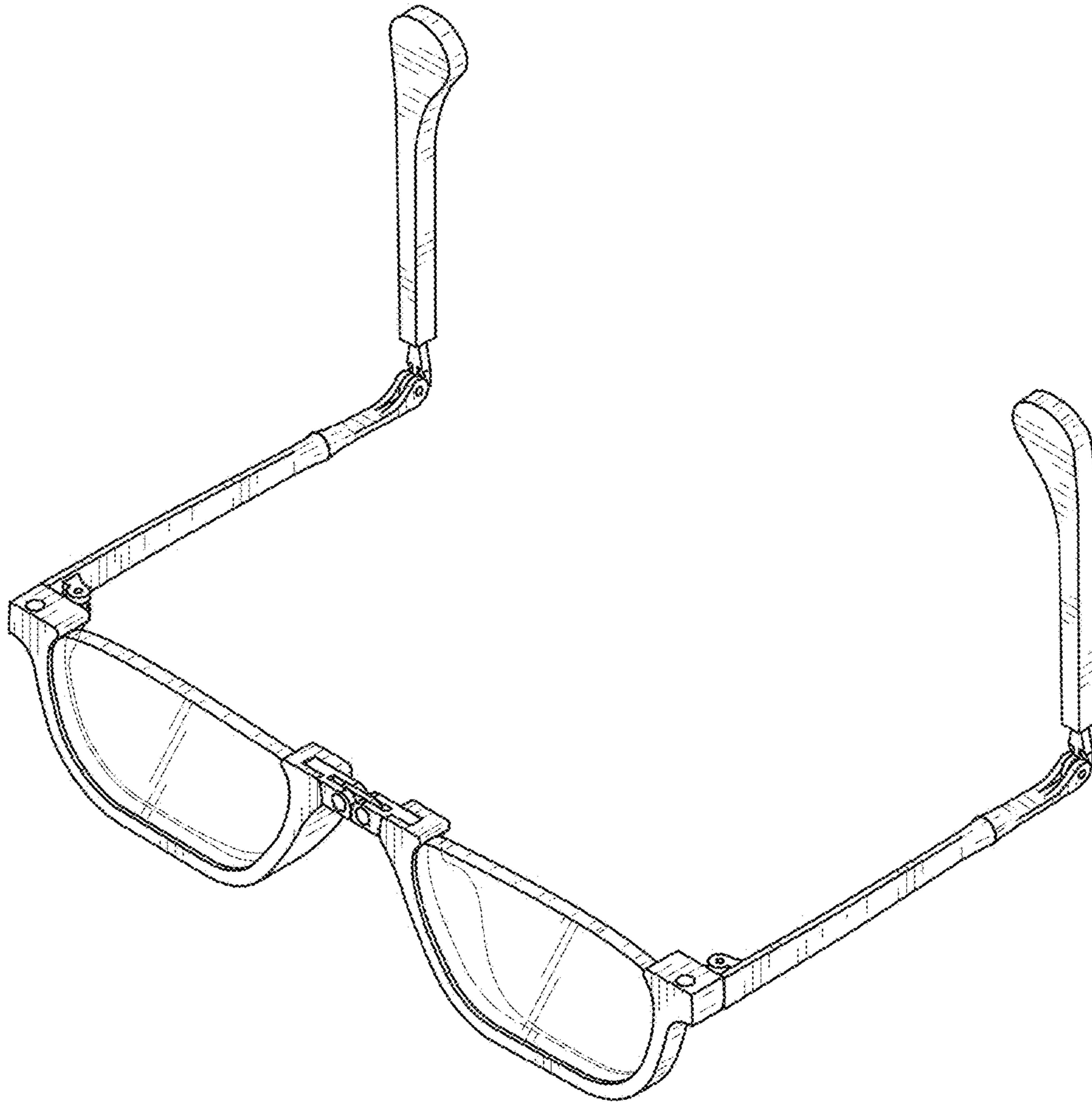

FIG. 20

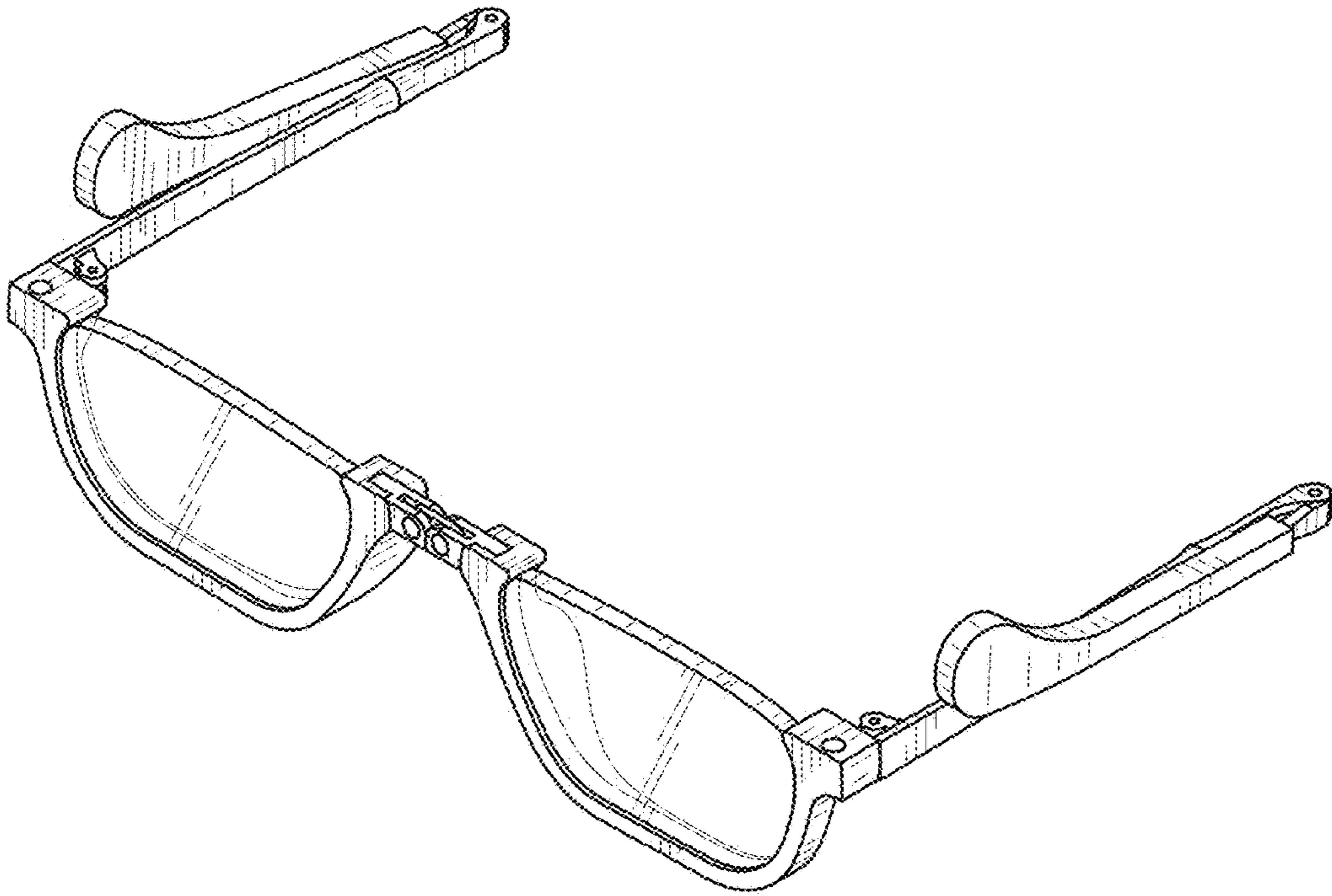

FIG. 21