



US00D827617S

(12) **United States Design Patent**  
**Dillon**

(10) **Patent No.:** **US D827,617 S**  
(45) **Date of Patent:** **\*\* Sep. 4, 2018**

- (54) **VIRTUAL REALITY HEADSET STAND**
- (71) Applicant: **Tree Cloud LLC**, Houston, TX (US)
- (72) Inventor: **Christopher Charles Dillon**, Houston, TX (US)
- (73) Assignee: **TREE CLOUD, LLC.**, Houston, TX (US)
- (\*\*) Term: **15 Years**
- (21) Appl. No.: **29/602,260**
- (22) Filed: **Apr. 28, 2017**
- (51) **LOC (11) Cl.** ..... **14-01**
- (52) **U.S. Cl.**  
USPC ..... **D14/224**
- (58) **Field of Classification Search**  
USPC ... D14/224, 224.1, 451, 155, 168, 149, 137, D14/461, 372, 229; D6/682.1, 672, 683; D8/356; D9/434; D13/107, 108; 174/154; D28/17, 61, 64.1, 38; 320/110, 320/111, 112; 381/368, 370, 336; 379/430, 431; 248/158; 211/33; 455/90.3, 575.1, 569.1  
CPC .. A47F 5/08; H04R 25/00; H04R 1/02; A47B 97/04; D04R 1/28; H05K 5/00; H05K 5/02; A47K 5/04  
See application file for complete search history.

- 2,552,921 A \* 5/1951 Anderson ..... G10G 5/00 248/167
- 3,192,894 A \* 7/1965 Staver ..... A47K 5/05 118/200
- D216,520 S \* 1/1970 Court ..... D6/681.1
- 4,040,547 A \* 8/1977 Dickey ..... F16M 13/04 224/247
- D251,426 S \* 3/1979 Molyneux ..... D14/229
- D257,083 S \* 9/1980 Gauthier ..... D14/224
- D300,214 S \* 3/1989 Adams ..... D13/108
- 4,984,076 A \* 1/1991 Watanabe ..... H04N 19/176 375/240.2
- D318,280 S \* 7/1991 Sumrell ..... D14/224
- 5,029,796 A \* 7/1991 Schoenig ..... G10G 5/00 248/166
- 5,046,131 A \* 9/1991 Takahashi ..... H04B 1/3877 455/572

(Continued)

*Primary Examiner* — Paula Allen Greene

(56) **References Cited**

**U.S. PATENT DOCUMENTS**

- 1,502,597 A \* 7/1924 Taylor ..... B65B 67/1227 248/100
- 1,627,652 A \* 5/1927 Kornicker ..... A47F 7/00 211/33
- 1,747,628 A \* 2/1930 Hagel ..... A41H 17/00 211/13.1
- 1,829,455 A \* 10/1931 Riley ..... B42D 5/005 248/460
- D140,701 S \* 3/1945 Somers ..... D14/229

(57) **CLAIM**

The ornamental design for a virtual reality headset stand, as shown and described.

**DESCRIPTION**

FIG. 1 is a perspective view of a virtual reality headset stand in accordance with one implementation;  
 FIG. 2 is a side view of the virtual reality headset stand of FIG. 1;  
 FIG. 3 is a side view of the virtual reality headset stand of FIG. 1;  
 FIG. 4 is a top view of the virtual reality headset stand of FIG. 1;  
 FIG. 5 is a bottom view of the virtual reality headset stand of FIG. 1;  
 FIG. 6 is a front view of the virtual reality headset stand of FIG. 1; and,  
 FIG. 7 is a rear view of the virtual reality headset stand of FIG. 1.

**1 Claim, 4 Drawing Sheets**

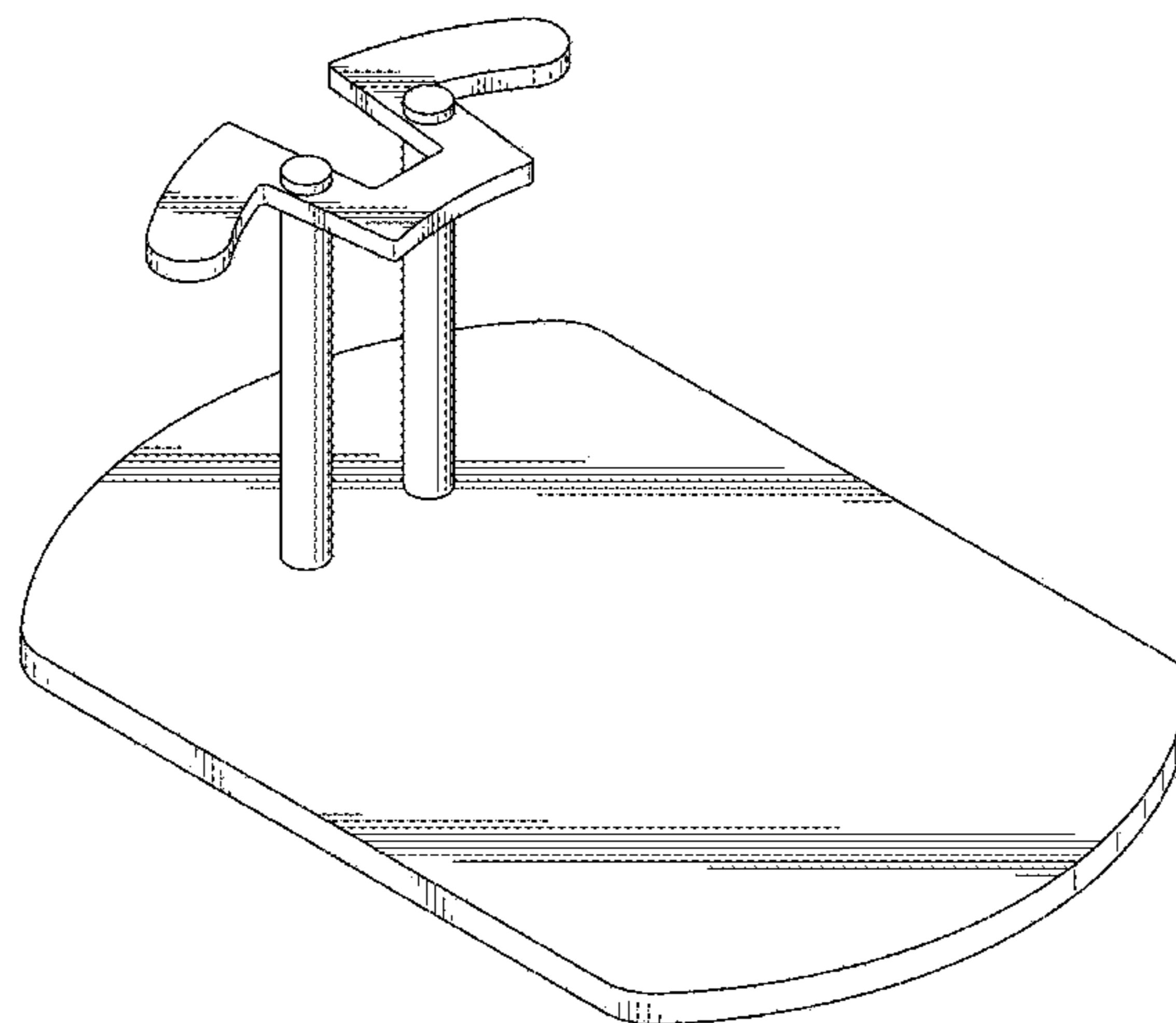

(56)

References Cited

U.S. PATENT DOCUMENTS

D323,753 S *	2/1992	Johnston	D11/131	D560,206 S *	1/2008	Hermansen	D14/206
5,095,382 A *	3/1992	Abe	H04B 10/114 320/107	D564,501 S *	3/2008	Rath	D14/224
D325,578 S *	4/1992	Daido	D14/155	D582,901 S *	12/2008	Bentley	D14/224
5,169,104 A *	12/1992	Kwoh	F16F 15/00 248/176.1	D589,031 S *	3/2009	Bentley	D14/224
D355,913 S *	2/1995	Chong	D14/155	D592,509 S *	5/2009	Lecoutre	D9/434
D357,248 S *	4/1995	Cheng	D14/137	D593,998 S *	6/2009	Bentley	D14/224
D357,481 S *	4/1995	Giuntoli	D14/227	D600,925 S *	9/2009	Guffey	D6/327
D360,887 S *	8/1995	Karnaze	D14/224	D602,008 S *	10/2009	Bentley	D14/205
D365,564 S *	12/1995	Luther	D14/227	D610,084 S *	2/2010	Christopher	D13/107
D387,784 S *	12/1997	Nakamura	D14/155	D625,183 S *	10/2010	Bartsch	D9/434
D392,290 S *	3/1998	Andrea	D14/206	D634,737 S *	3/2011	Lippert	D14/229
D397,120 S *	8/1998	Liou	D14/229	D662,089 S *	6/2012	Gougherty	D14/224
D399,210 S *	10/1998	Rozier	D14/224	D663,292 S *	7/2012	Hoggarth	D14/224
D409,020 S *	5/1999	Hardin	D6/654.21	D669,888 S *	10/2012	Gougherty	D14/223
D410,968 S *	6/1999	Swan	D20/22	D684,145 S *	6/2013	Rath	D14/206
D461,794 S *	8/2002	Polito	D14/224	D685,806 S *	7/2013	Kim	D14/451
D496,029 S *	9/2004	Skulley	D14/224	8,838,029 B2 *	9/2014	Goldman	H04M 1/04 455/41.2
6,813,771 B2 *	11/2004	Weaver	G11B 33/0455 720/600	D723,011 S *	2/2015	Symons	D14/224
D510,905 S *	10/2005	Thirouin	D13/108	D730,327 S *	5/2015	Mun	D14/229
D511,492 S *	11/2005	Allende Fritsch	D13/108	D761,045 S *	7/2016	Hassinen	D6/683
D517,519 S *	3/2006	Skulley	D13/108	D761,759 S *	7/2016	He	D14/204
D519,975 S *	5/2006	Skulley	D13/108	D780,490 S *	3/2017	James	D6/682
D523,412 S *	6/2006	Ham	D13/108	D788,080 S *	5/2017	Turksu	D14/224
				D813,850 S *	3/2018	Young, III	D14/224
				2004/0011932 A1 *	1/2004	Duff	F16M 11/10 248/157
				2005/0103957 A1 *	5/2005	Chang	F16M 13/00 248/127

\* cited by examiner

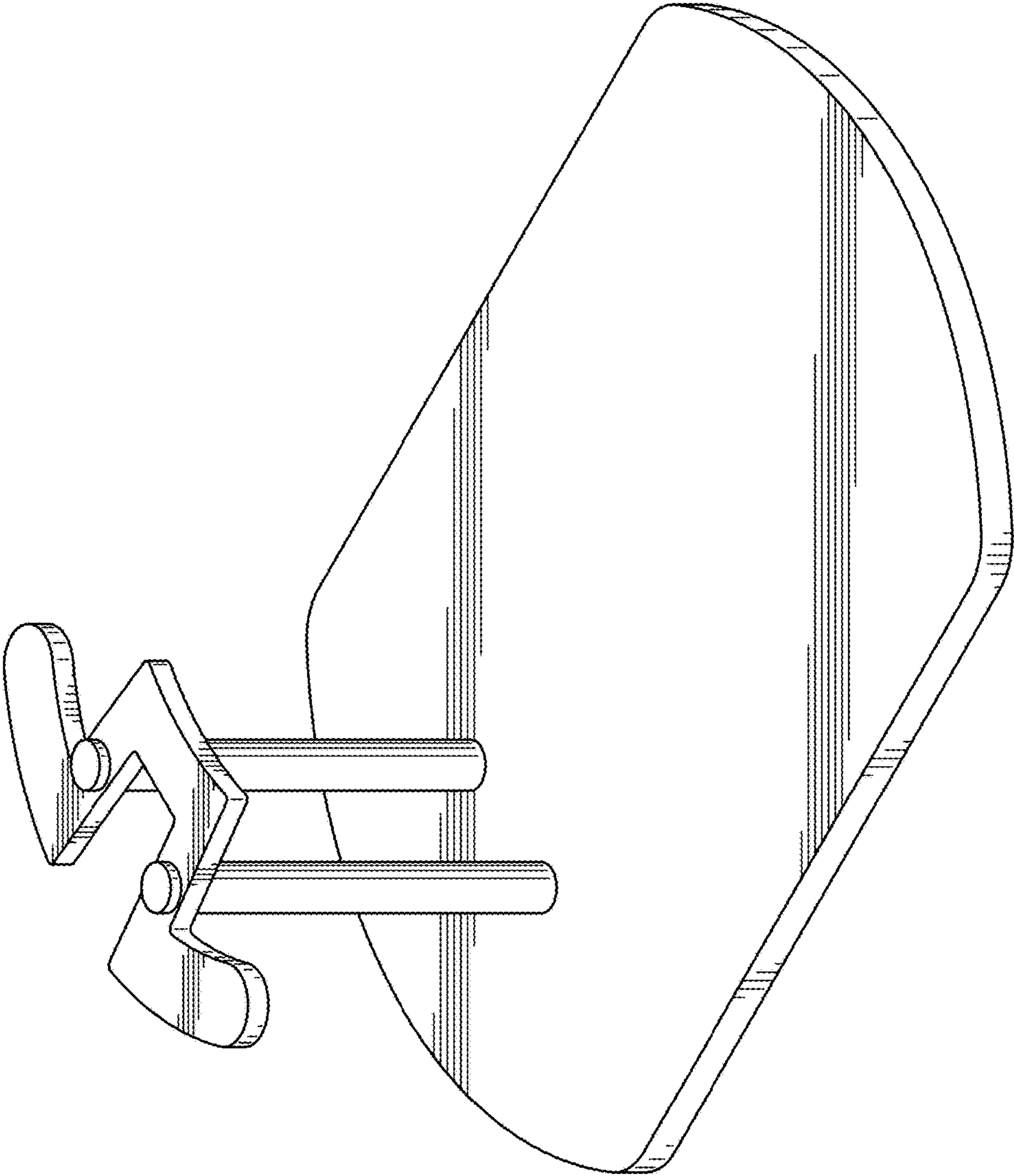

FIG. 1

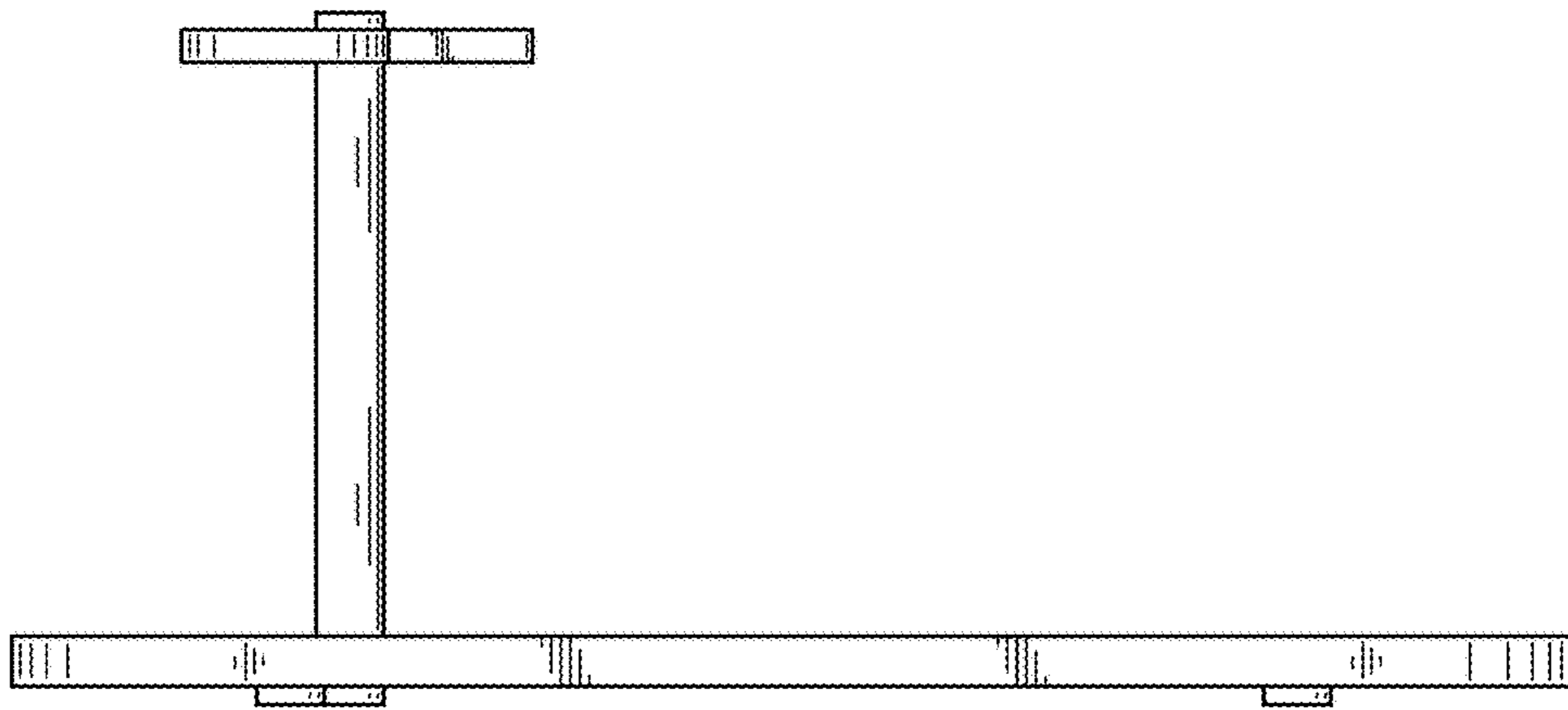

FIG. 2

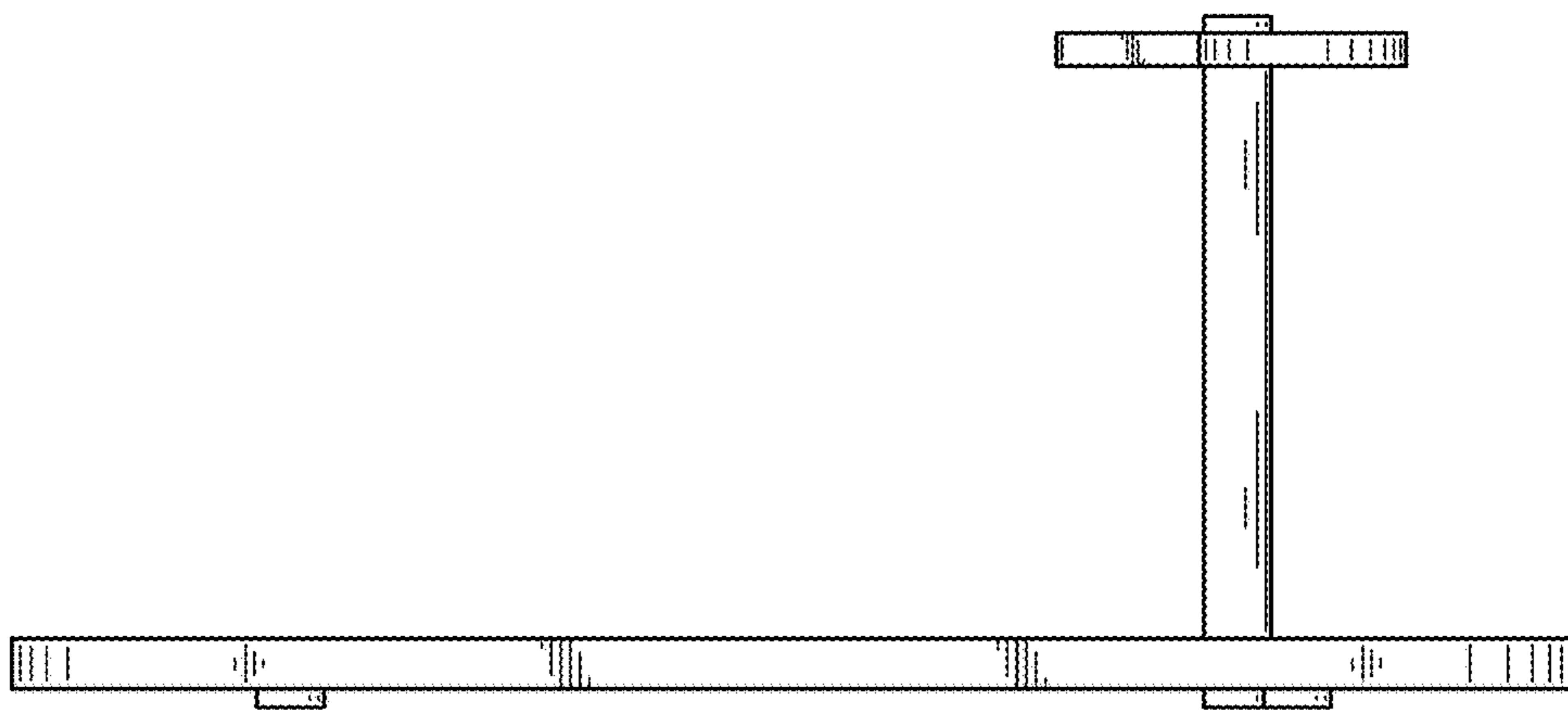

FIG. 3

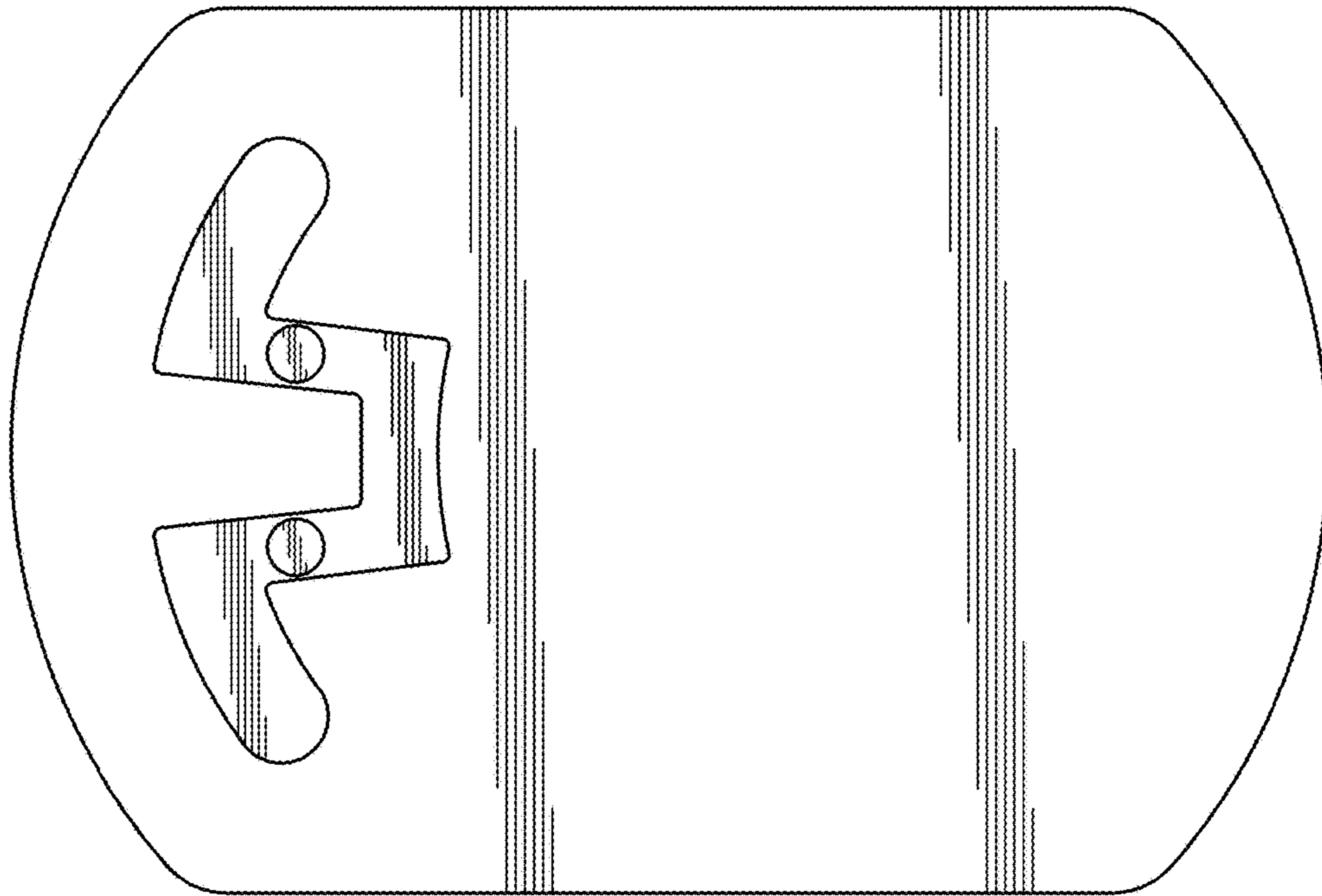

FIG. 4

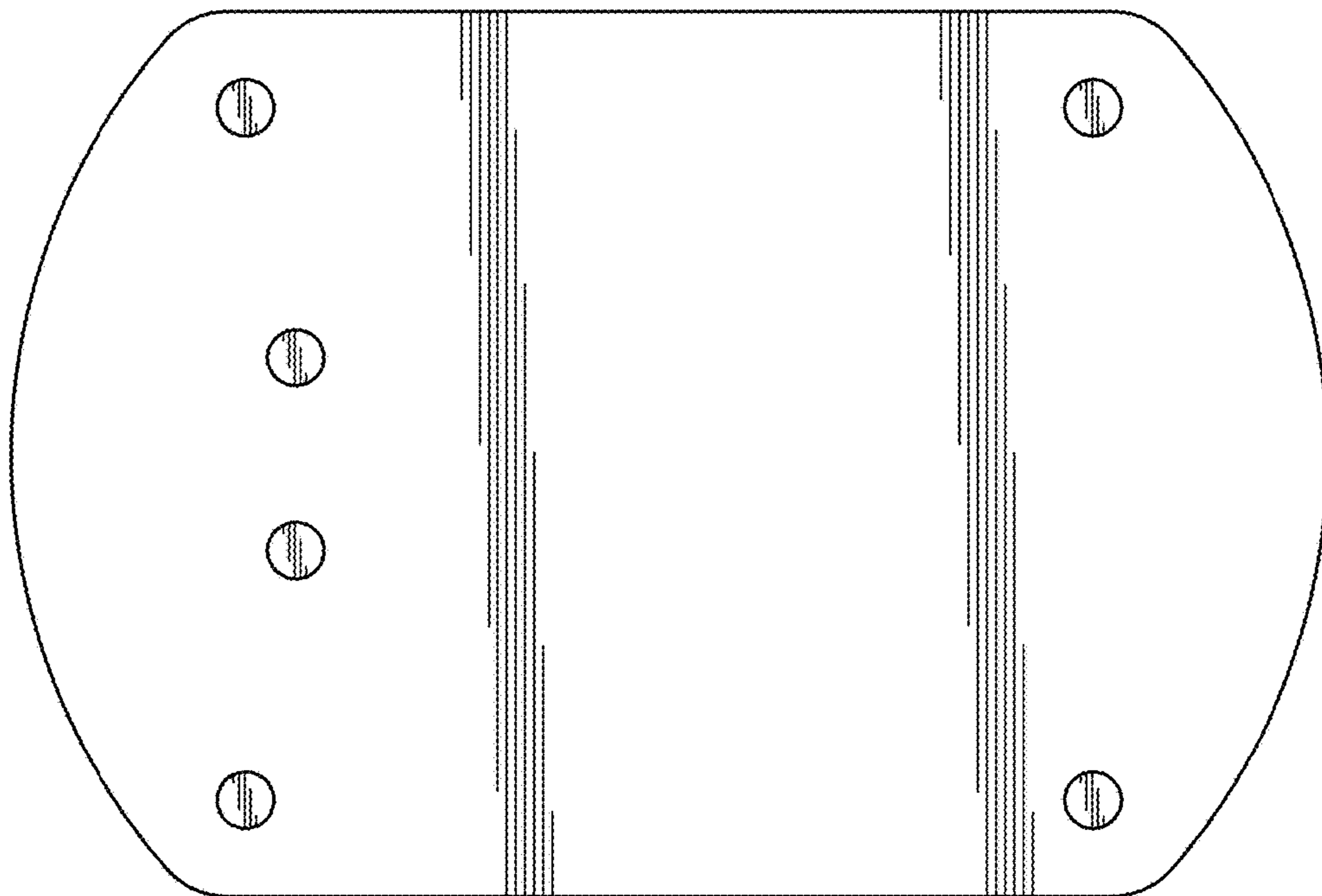

FIG. 5

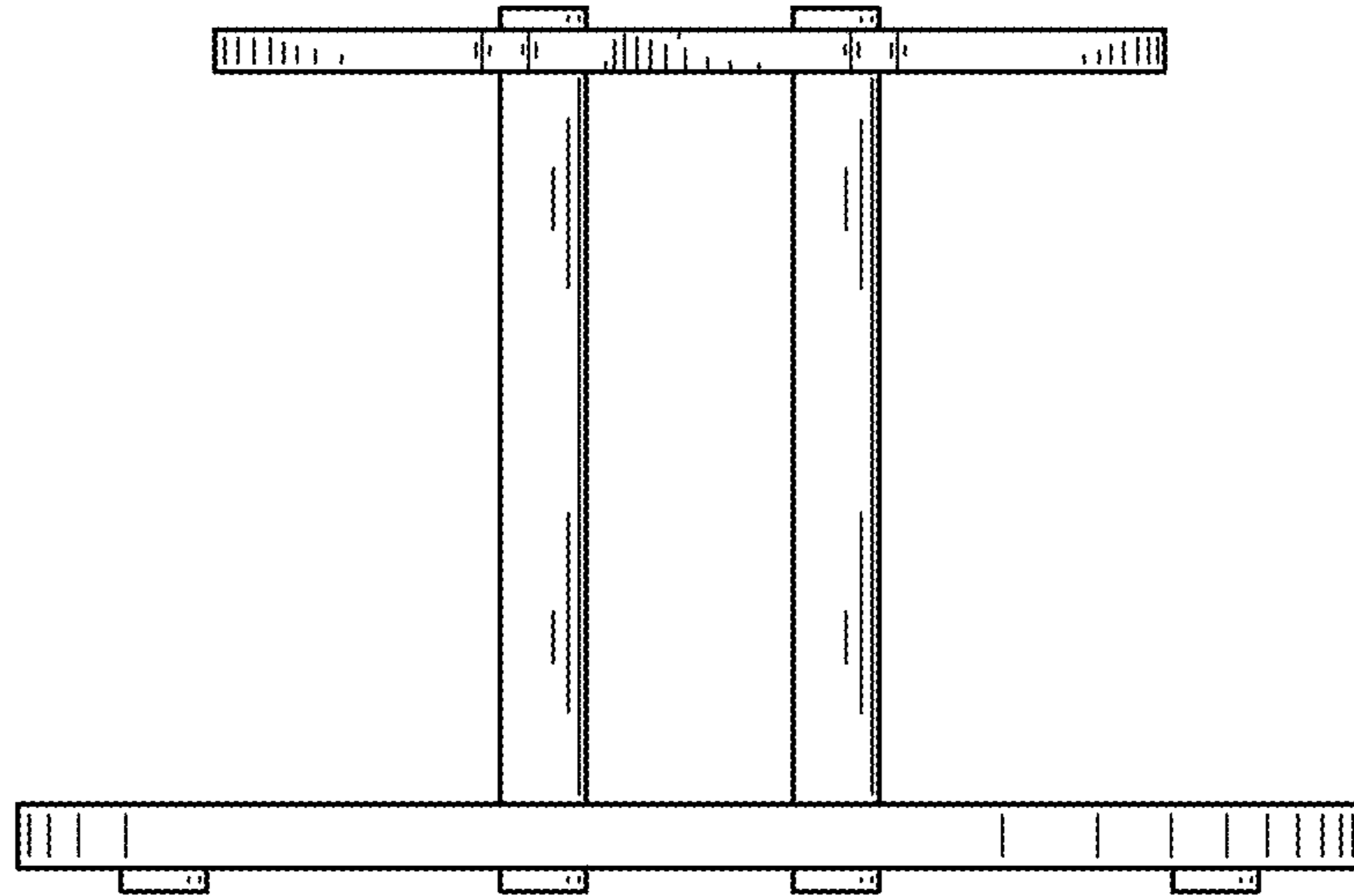

FIG. 6

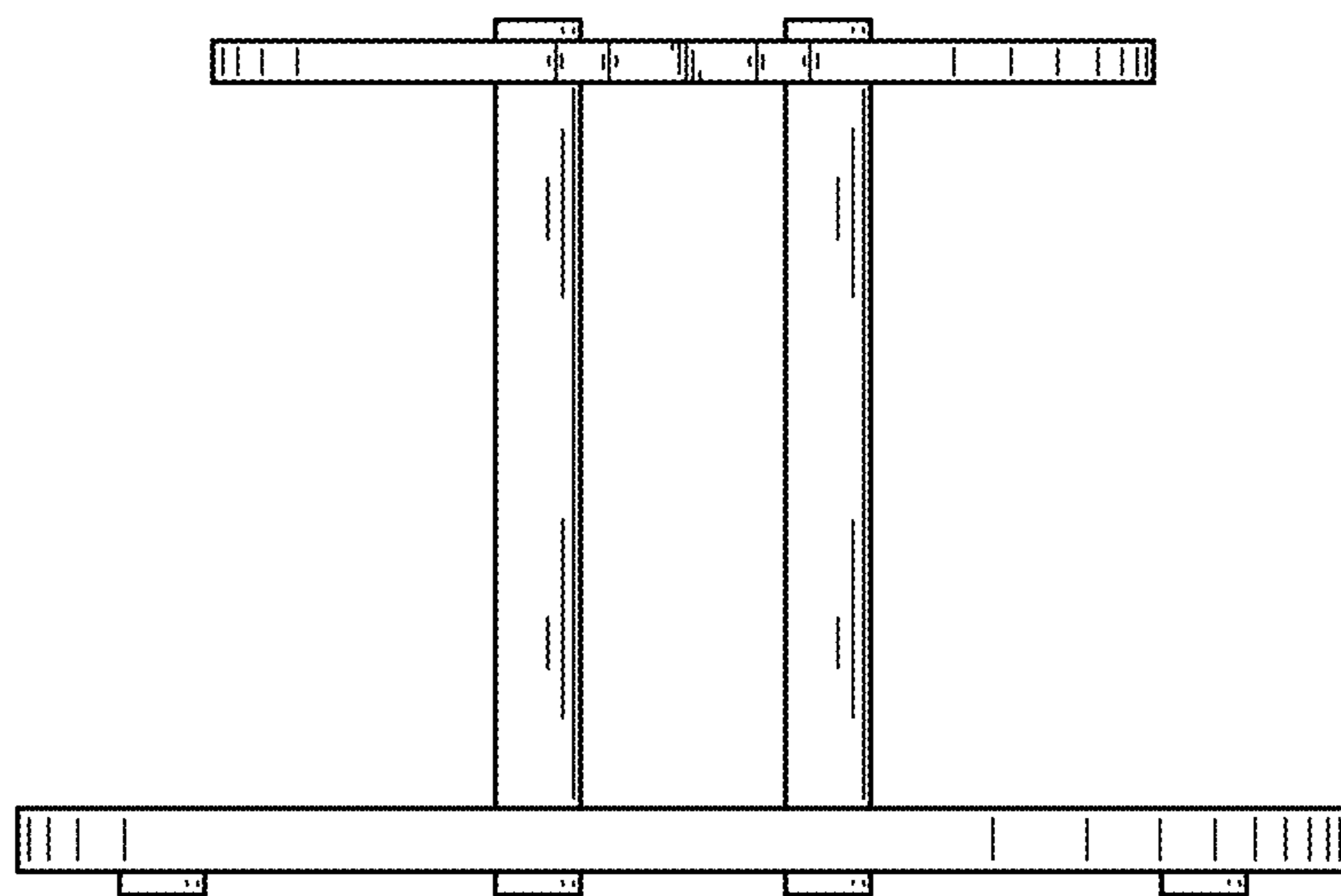

FIG. 7