



US00D827484S

(12) **United States Design Patent** (10) **Patent No.:** **US D827,484 S**  
**McSpadden et al.** (45) **Date of Patent:** **\*\* Sep. 4, 2018**

(54) **COMBINED HEART HOOK AND OPEN HEART EYE CLASP FOR JEWELRY**

(71) Applicant: **Texas Automation Products, Inc.**, Mesquite, TX (US)

(72) Inventors: **Karen Rae Womack McSpadden**, Forney, TX (US); **Joe Edward McSpadden, II**, Forney, TX (US)

(73) Assignee: **Texas Automation Products, Inc.**, Mesquite, TX (US)

(\*\*) Term: **15 Years**

(21) Appl. No.: **29/594,482**

(22) Filed: **Feb. 17, 2017**

(51) **LOC (11) Cl.** ..... **11-01**

(52) **U.S. Cl.**  
USPC ..... **D11/87; D11/211**

(58) **Field of Classification Search**  
USPC ..... **D11/40-47, 75, 79, 85-89; 63/1.11, 3, 63/3.1, 3.2, 5.1, 5.2, 7-11, 22, 23, 38;**  
(Continued)

(56) **References Cited**

**U.S. PATENT DOCUMENTS**

5,203,183 A \* 4/1993 Salerno ..... A44C 7/00  
63/12  
D538,531 S \* 3/2007 Chua ..... D3/211  
(Continued)

**OTHER PUBLICATIONS**

Open Heart Catch Bracelet, available Sep. 25, 2014, [online], [site visited Dec. 4, 2017]. Available from internet, <URL: [https://www.amazon.com/dp/B00M1OM6XW/ref=asc\\_df\\_B00M1OM6XW1512298800000?tag=merbethomgardivinecaroline-20&creative=395261&creativeASIN=B00M1OM6XW&linkCode=asn&ascsubtag=245315620](https://www.amazon.com/dp/B00M1OM6XW/ref=asc_df_B00M1OM6XW1512298800000?tag=merbethomgardivinecaroline-20&creative=395261&creativeASIN=B00M1OM6XW&linkCode=asn&ascsubtag=245315620)> (Year: 2014).\*

(Continued)

*Primary Examiner* — Cathron C Brooks

*Assistant Examiner* — W. A. Teddy Falloway

(74) *Attorney, Agent, or Firm* — Ferguson Braswell  
Fraser Kubasta PC; Elizabeth Philip Dahm; Kelly J. Kubasta

(57) **CLAIM**

The ornamental design for a combined heart hook and open heart eye clasp for jewelry, as shown and described.

**DESCRIPTION**

FIG. 1 is a front view of a first embodiment of a combined heart hook and open-heart eye clasp for jewelry;

FIG. 2 is a top, front perspective view thereof, shown in an alternative position, wherein the jewelry is bent and the hook and eye clasp are unclashed;

FIG. 3 is a top, front perspective view thereof, wherein the hook and eye clasp are clasped;

FIG. 4 is a top, rear perspective view thereof;

FIG. 5 is a first side view thereof;

FIG. 6 is a second side view thereof;

FIG. 7 is a bottom, front perspective view thereof;

FIG. 8 is a front view of the design shown in FIG. 1, but shown with a heart and shield in broken lines;

FIG. 9 is a front view of the design shown in FIG. 1, but shown with an encircled star in broken lines;

FIG. 10 is a front view of the design shown in FIG. 1, but shown with a nameplate in broken lines;

FIG. 11 is a single, top, front perspective view of a second embodiment, shown with chain links in broken lines;

FIG. 12 is a front view of a third embodiment of the design shown in FIG. 1, but shown with a heart-shaped opening in the hook;

FIG. 13 is a front view of the design shown in FIG. 12, but shown with a heart and shield in broken lines;

FIG. 14 is a partial front view of a fourth embodiment of the design shown in FIG. 1; the only difference being the shape of the heart hook; and,

FIG. 15 is a partial front view of a fifth embodiment of the design shown in FIG. 1; the only difference being the shape of the heart eye clasp.

The broken lines showing a heart-shaped opening in FIGS. 12 and 13 illustrate portions of the combined heart hook and open-heart eye clasp for jewelry. The broken lines showing

(Continued)

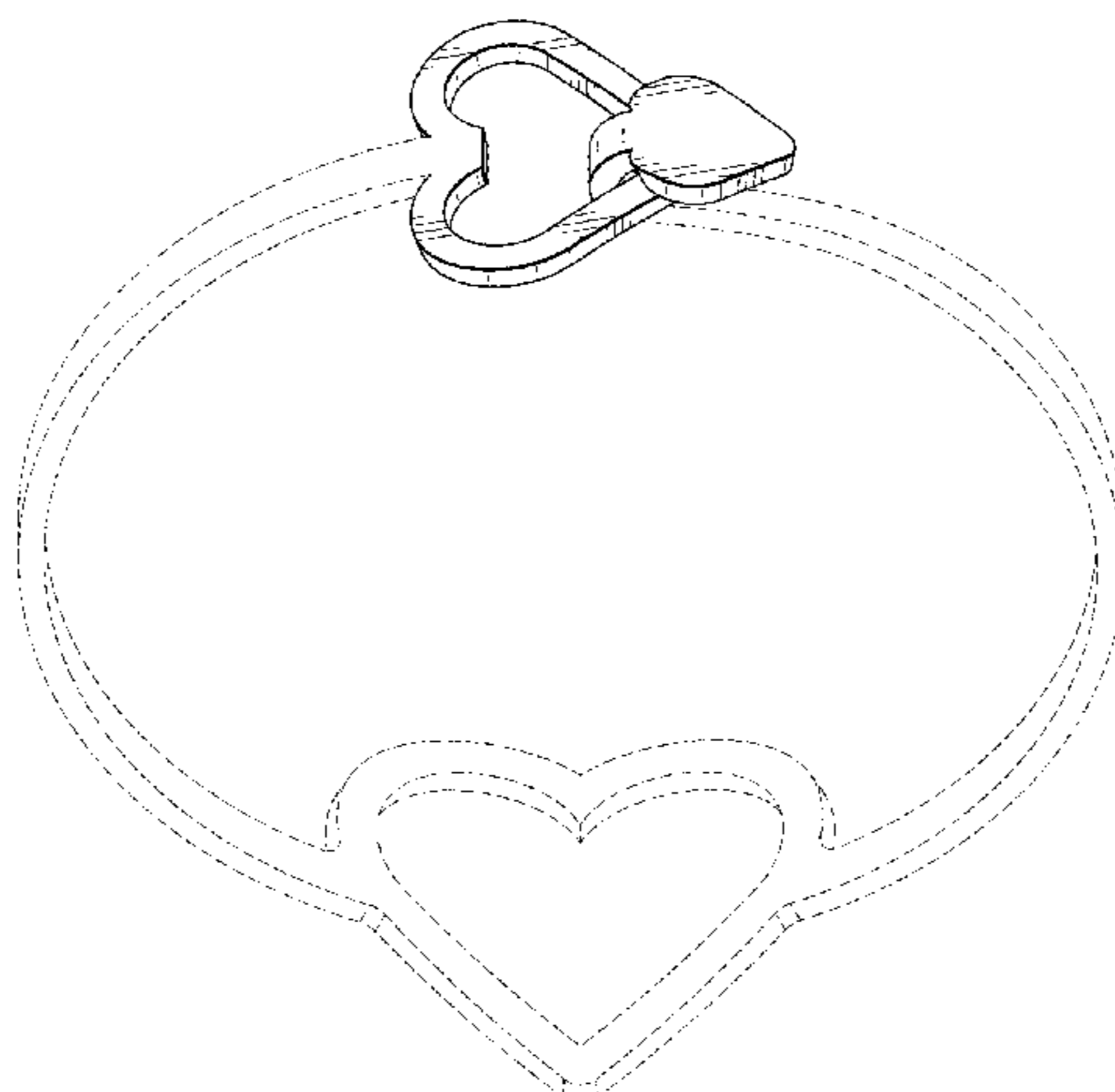

portions of bracelets represent environmental structure. The broken lines form no part of the claimed design.

**1 Claim, 10 Drawing Sheets**

(58) **Field of Classification Search**

USPC ..... 59/80–90, 93, 78, 79.2, 95; 24/647, 24/116 R, 684, 43, 572.1, 574.1  
 CPC ..... A44C 5/185; A44C 5/2009; A44C 5/2019; A44C 5/0053; A44C 5/0085; A44C 5/005; A44C 5/2057; A44B 13/00  
 See application file for complete search history.

(56) **References Cited**

U.S. PATENT DOCUMENTS

D542,171 S *	5/2007	Olson	.....	D11/1
D550,113 S *	9/2007	Osterbaek	.....	D11/56
D636,693 S *	4/2011	Hegi	.....	D11/1
D654,390 S *	2/2012	Sivriere	.....	D11/26
D656,053 S *	3/2012	Bax Stas	.....	D11/1
D657,281 S *	4/2012	Psaute	.....	D11/11
D715,942 S *	10/2014	Allen	.....	D24/158
D724,472 S *	3/2015	Blondet	.....	D11/5
D766,125 S *	9/2016	Behney	.....	D11/56
D767,438 S *	9/2016	Behney	.....	D11/56

D783,437 S *	4/2017	Gruosi-Scheufele	.....	D11/4
D801,210 S *	10/2017	Behney	.....	D11/81
2015/0075218 A1 *	3/2015	Stepper	.....	A44C 5/12 63/3.2

OTHER PUBLICATIONS

Heartfelt Bangle, available Oct. 17, 2015, [online], [site visited Dec. 4, 2017]. Available from internet, <URL: <https://web.archive.org/web/20151017163142/https://www.blingjewelry.com/bling-jewelry-gold-plated-thin-stackable-modern-heart-bangle-bracelet-925-silver.html> (Year: 2015).\*

Double Heart Classic Bangle, available Dec. 4, 2017, [online], [site visited Dec. 4, 2017]. Available from internet, <URL: <https://www.mydailystyles.com/collections/womens-bracelets/products/ab855?variant=19640688582> (Year: 2017).\*

Gold Heart Bangles, available Dec. 4, 2017, [online], [site visited Dec. 4, 2017]. Available from internet, <URL: <https://jewelrytoolbox.com/products/gold-heart-bangles-stainless-steel-bracelet-finding-charm-bracelet-component-60mm-diameter-lot-size-10-1805-g> (Year: 2017).\*

Double Heart Classic Bangle, available Dec. 4, 2017, [online], [site visited Dec. 4, 2017]. Available from internet, <URL: [http://www.pukudesign.co.nz/women-jewellery-sc-1\\_4/women-silver-silver-sterling-simply-heart-and-mini-heart-catch-bangle-jewellery-sp-16317.html](http://www.pukudesign.co.nz/women-jewellery-sc-1_4/women-silver-silver-sterling-simply-heart-and-mini-heart-catch-bangle-jewellery-sp-16317.html) (Year: 2017).\*

\* cited by examiner

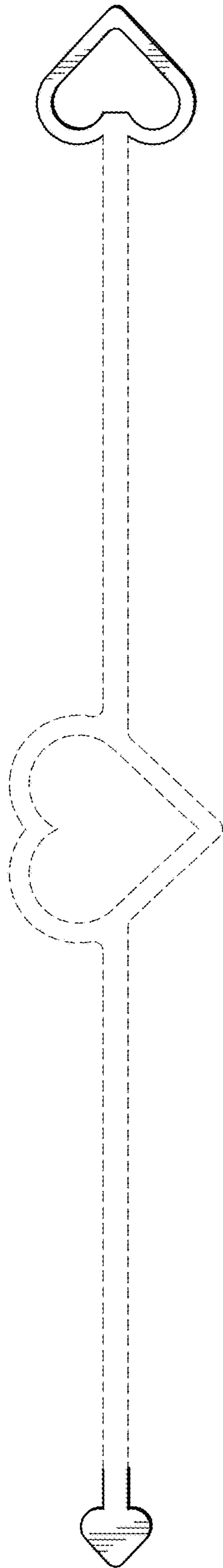

FIG. 1

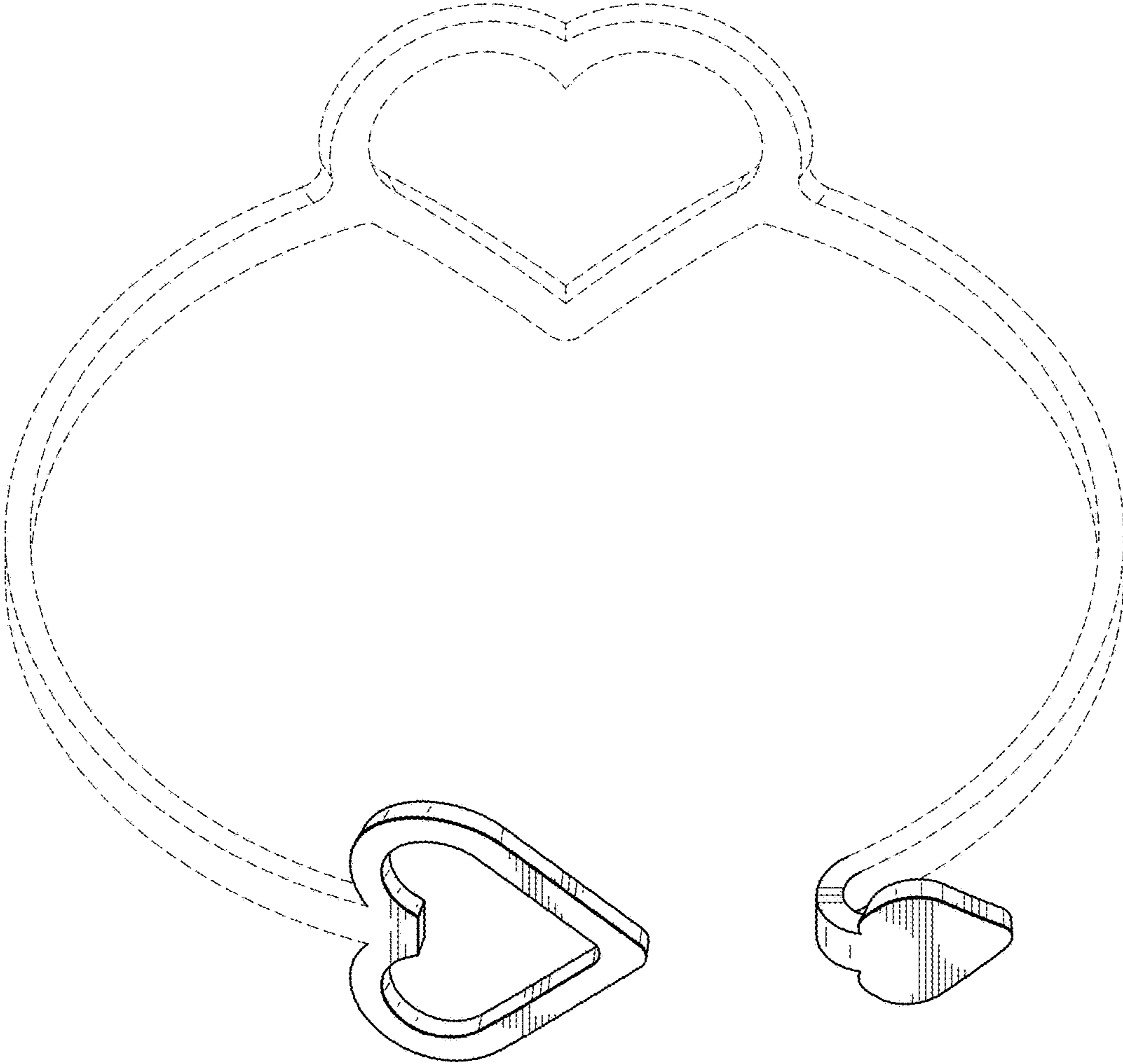

FIG. 2

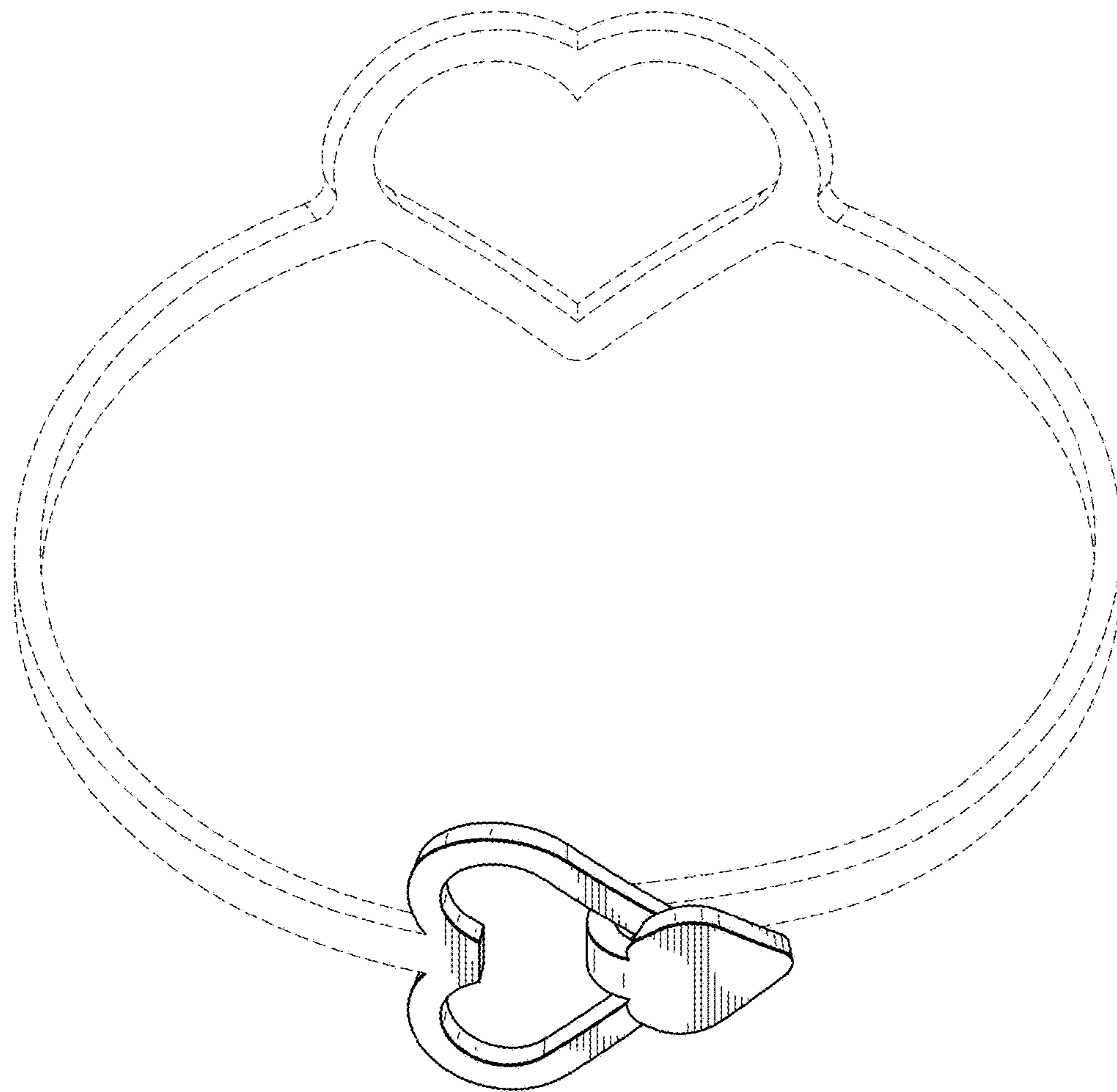

FIG. 3

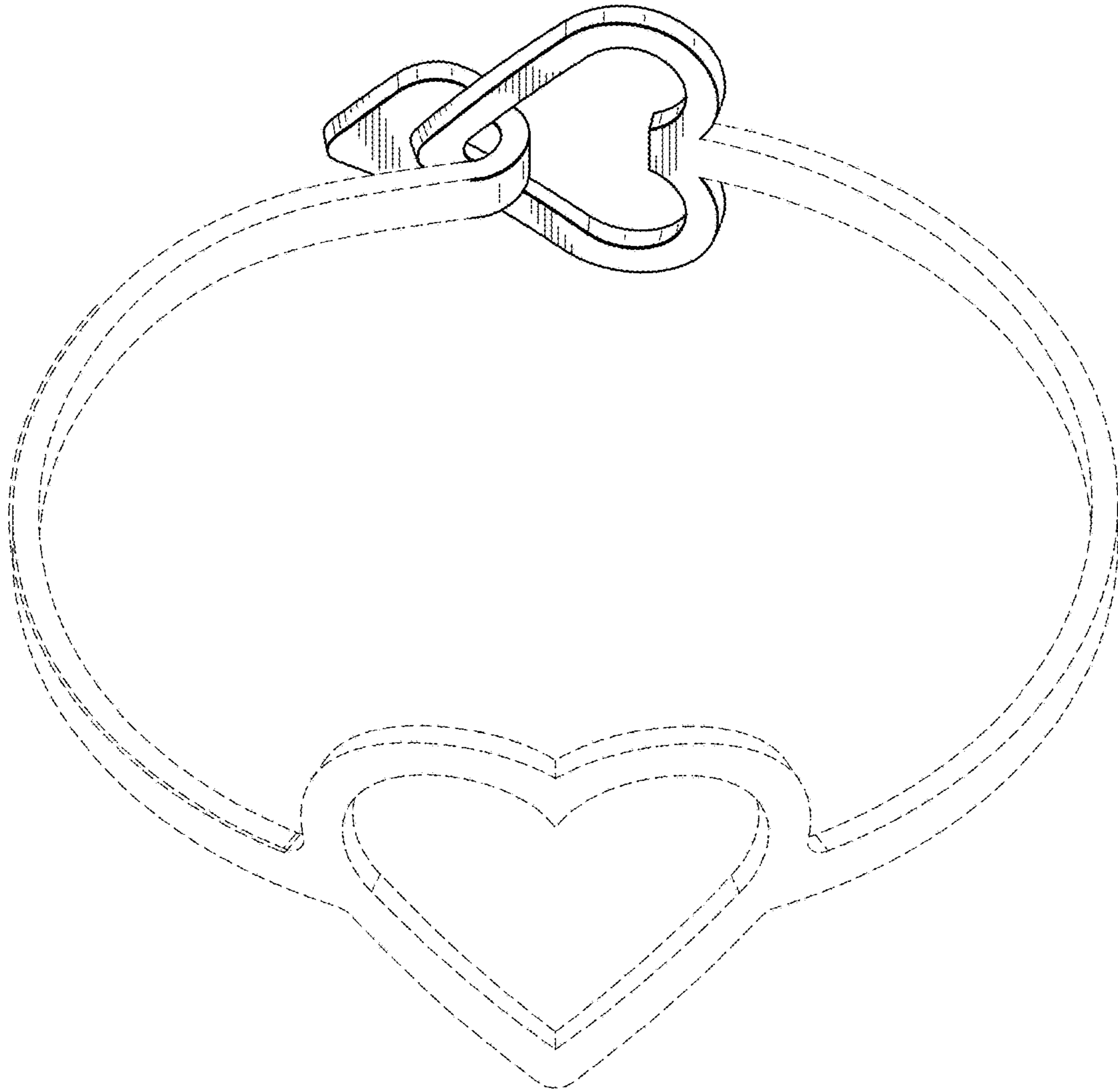

FIG. 4

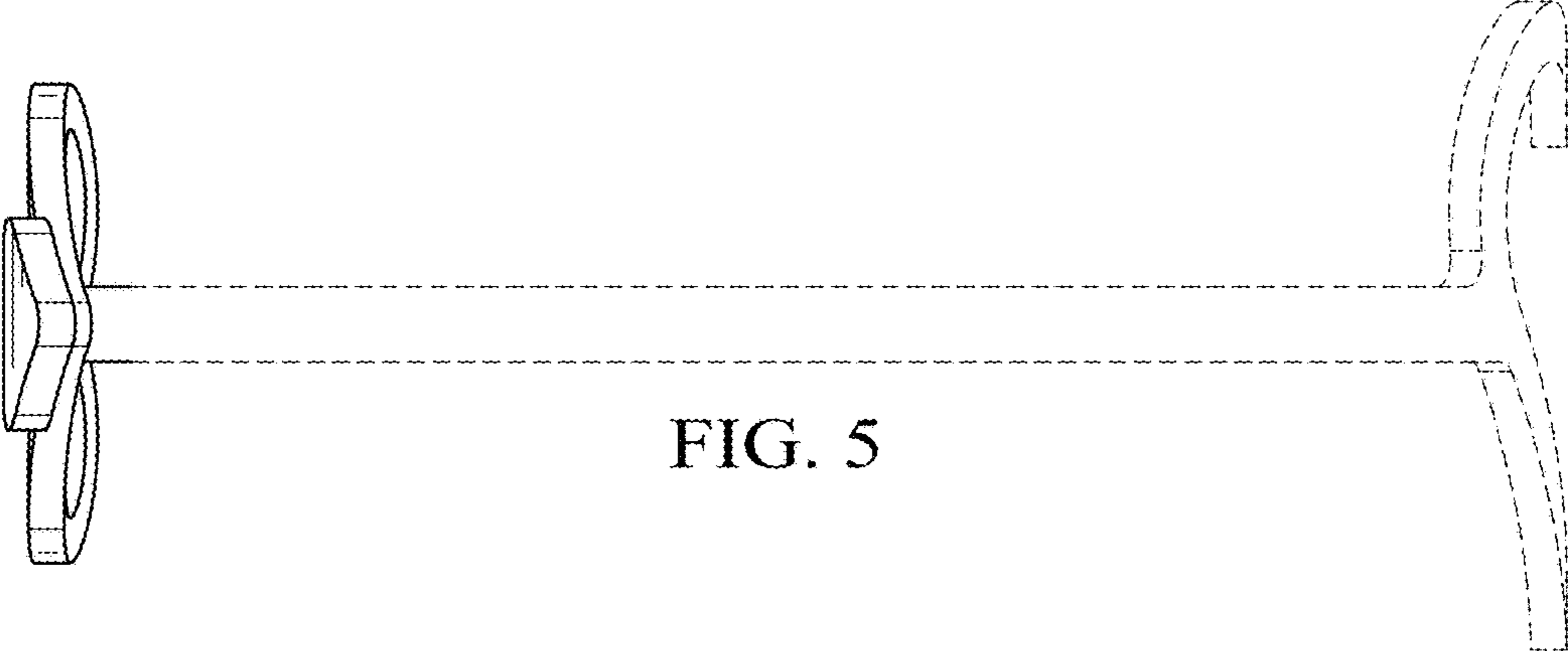

FIG. 5

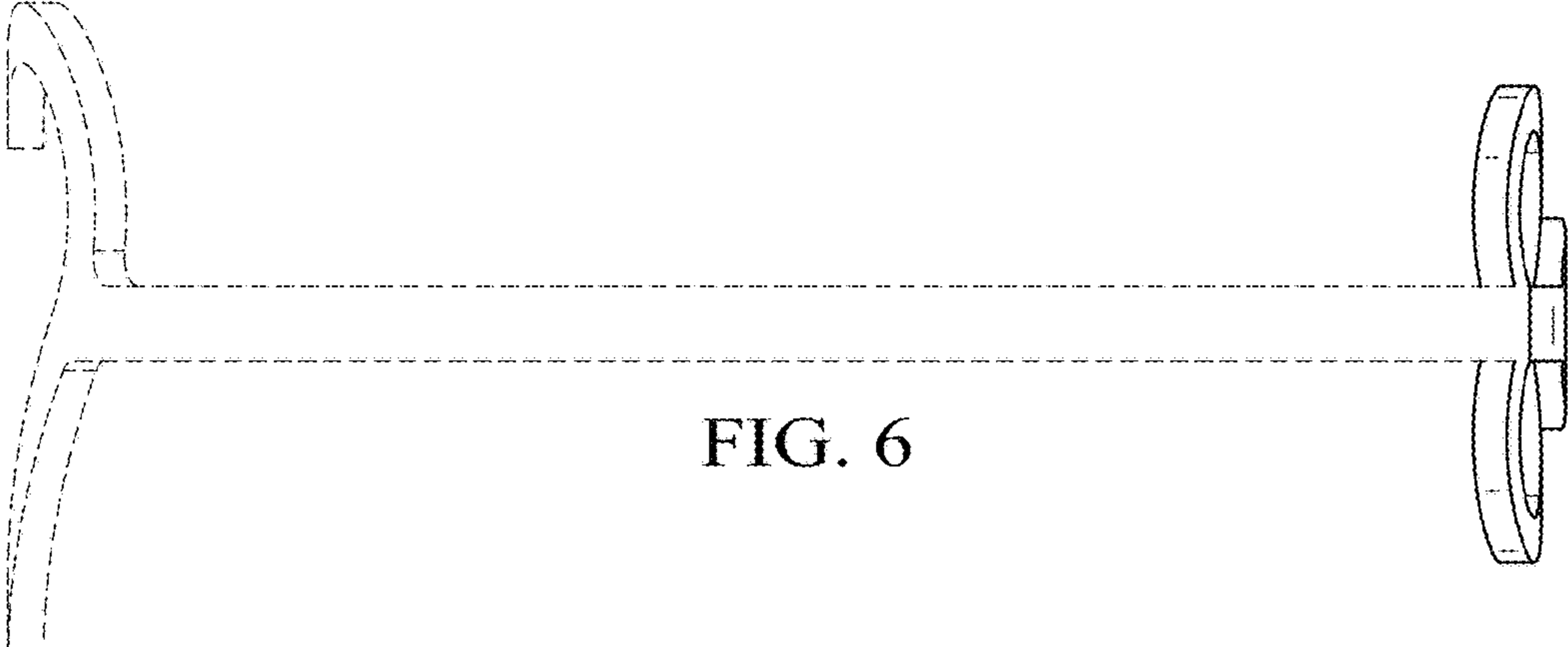

FIG. 6

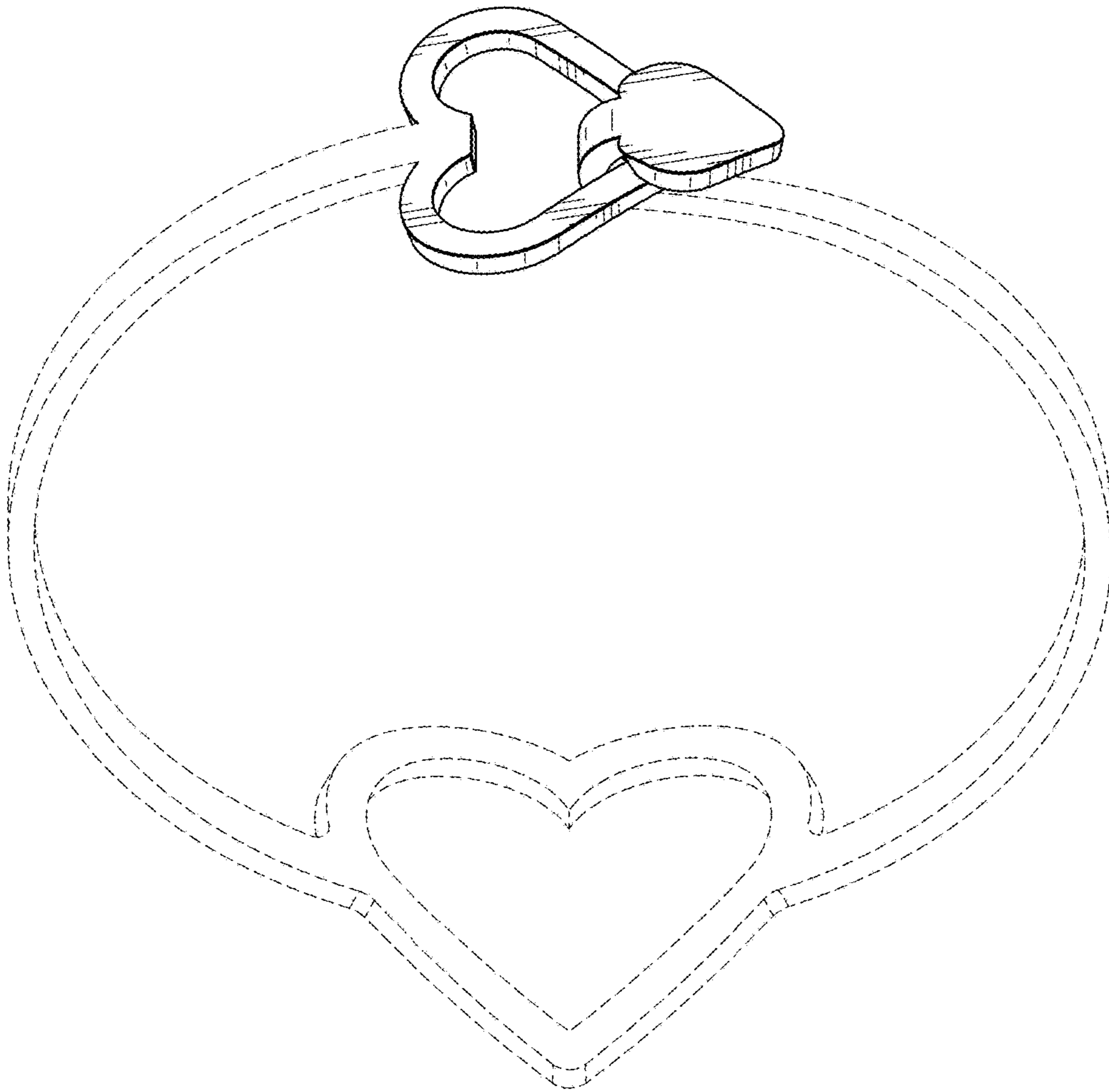

FIG. 7



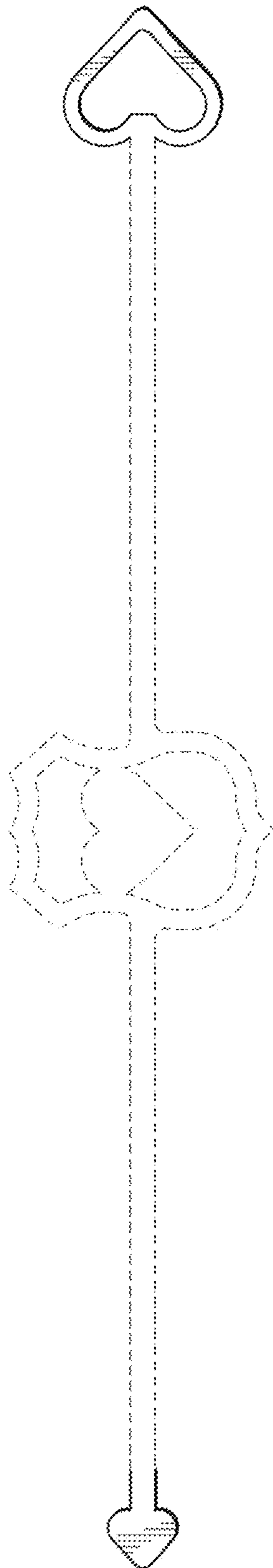

FIG. 8

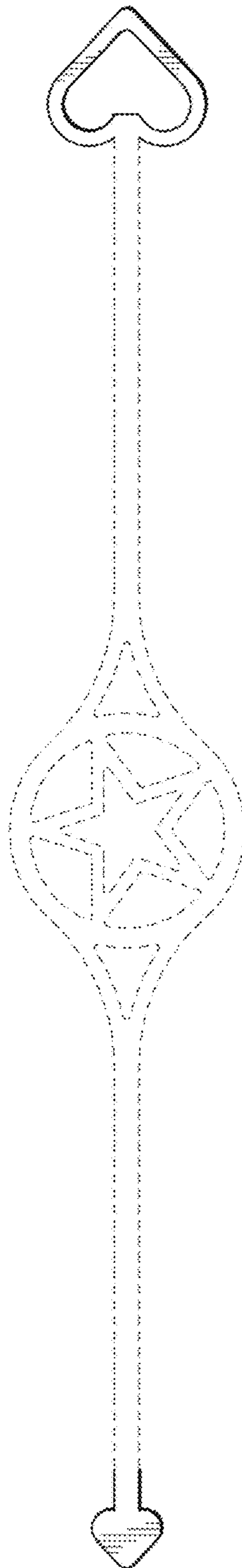

FIG. 9

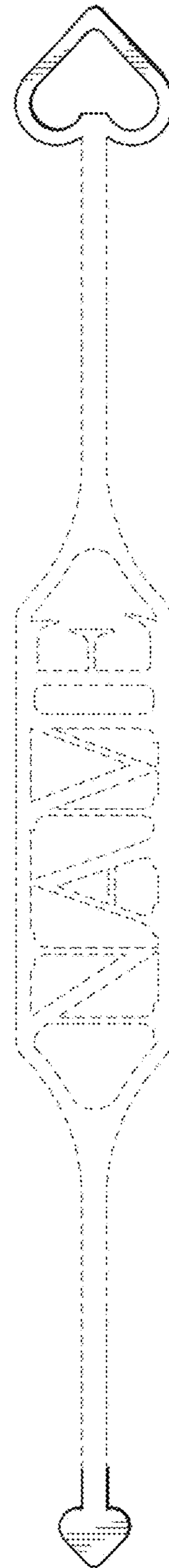

FIG. 10

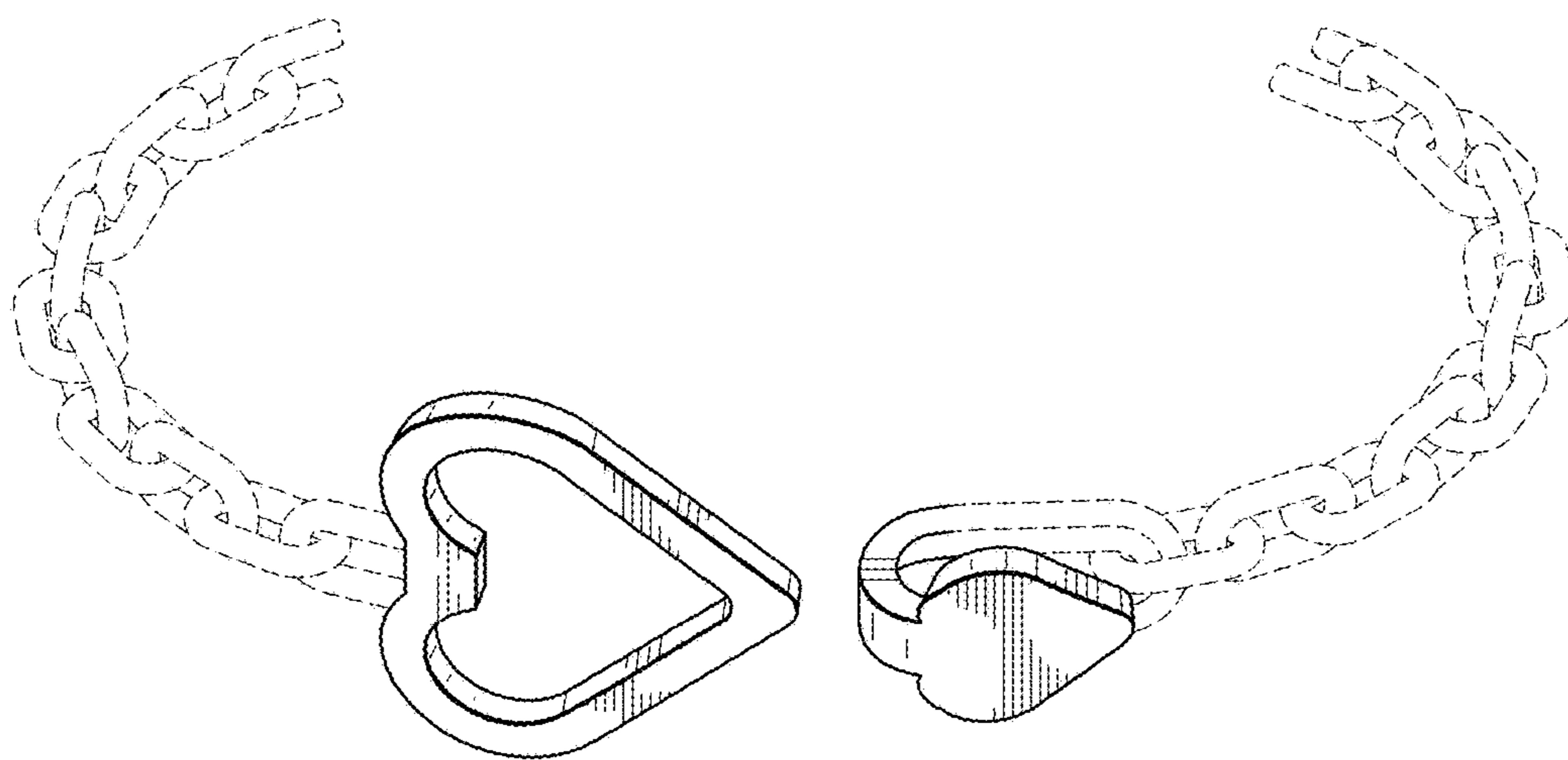

FIG. 11

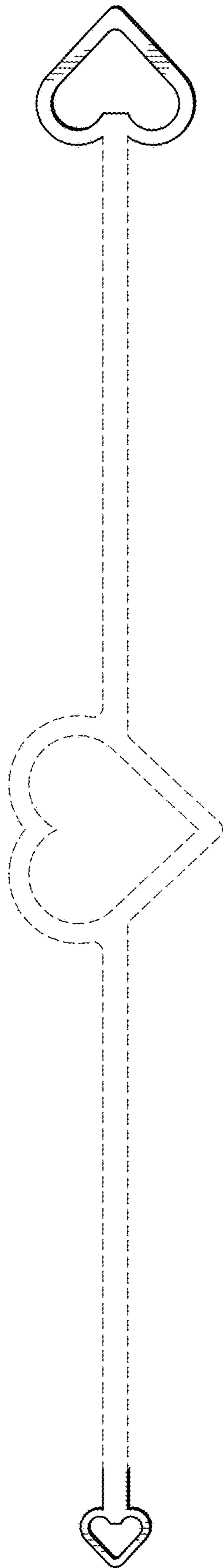

FIG. 12

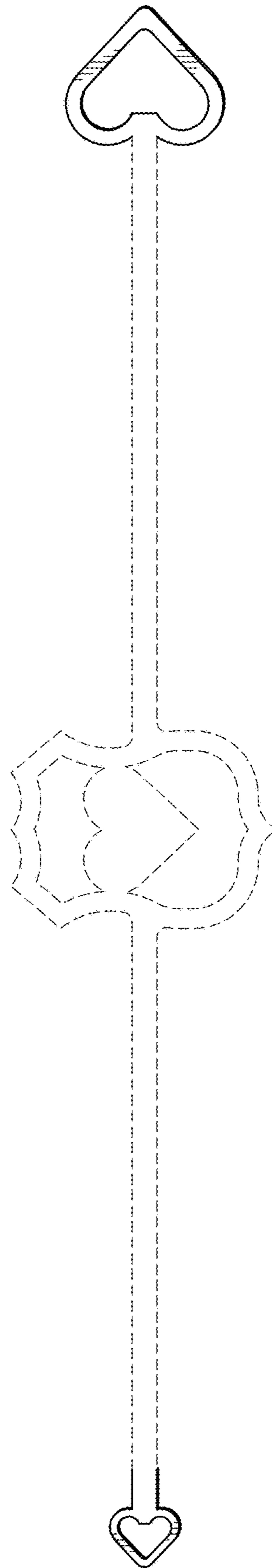

FIG. 13

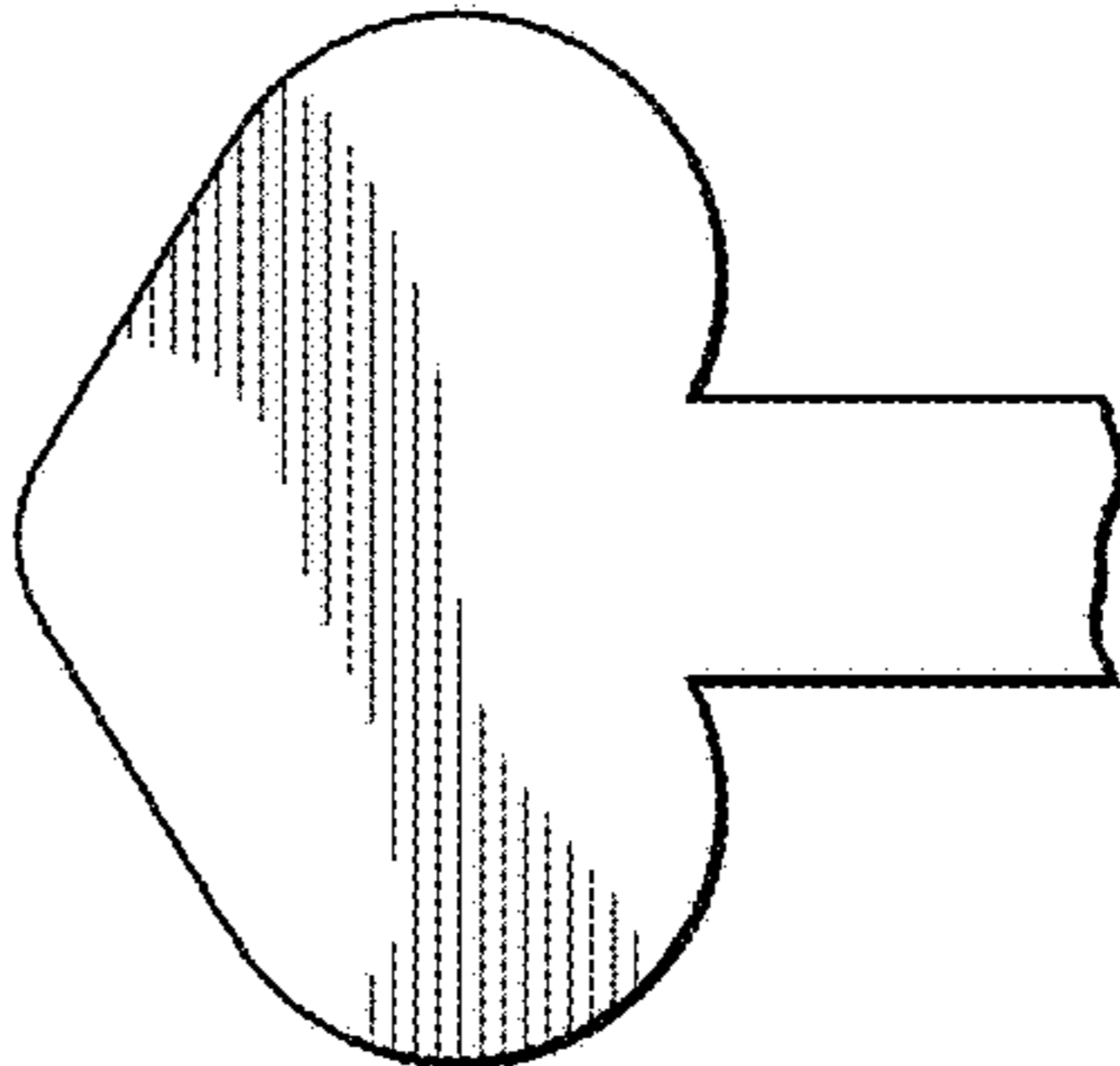

FIG. 14

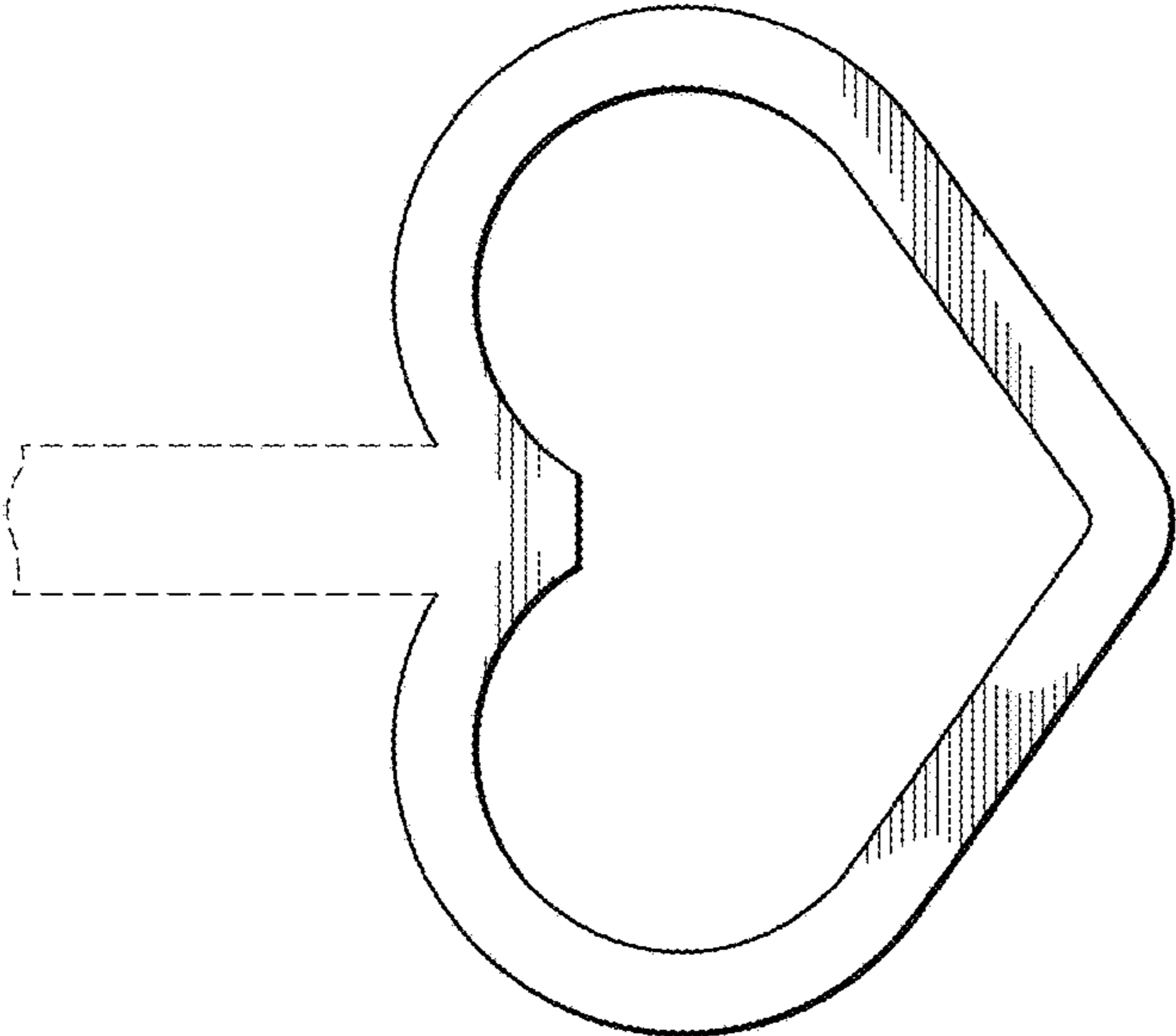

FIG. 15