



US00D827453S

(12) **United States Design Patent**
Davoli

(10) **Patent No.:** **US D827,453 S**
(45) **Date of Patent:** **** Sep. 4, 2018**

(54) **POCKET WATCH**
(71) Applicant: **Richemont International SA,**
Villars-sur-Glane (CH)
(72) Inventor: **Laurent Davoli,** Geneva (CH)
(73) Assignee: **Richemont International SA,**
Villars-sur-Glane (CH)

D68,117 S * 9/1925 Ritschard D10/131
D71,778 S * 1/1927 Conant D10/131
1,792,700 A * 2/1931 Nelson G04B 3/045
368/302
2,189,639 A * 2/1940 Masses G04B 19/223
116/307
D122,111 S * 8/1940 Blow D10/30
D126,622 S * 4/1941 Didisheim 368/232
2,352,889 A * 7/1944 Drescher G04B 3/045
368/288

(**) Term: **15 Years**

(Continued)

(21) Appl. No.: **29/606,456**

OTHER PUBLICATIONS

(22) Filed: **Jun. 5, 2017**

Piaget Altiplano 60th anniversary collection | posted at hodinkee.com Dec. 9, 2016 © 2009-2018 [online][site visited Mar. 28, 2018]. Available from Internet: <<https://www.hodinkee.com/articles/piaget-altiplano-60th-anniversary-collection>> (Year: 2016).*

(30) **Foreign Application Priority Data**

(Continued)

Dec. 5, 2016 (WO) DM/093748

(51) **LOC (11) Cl.** **10-02**

(52) **U.S. Cl.**
USPC **D10/37**

(58) **Field of Classification Search**
USPC D10/1-2, 6-10, 14-15, 22, 30-39, 65,
D10/70, 97-98, 122-126, 128; D14/344;
D24/167, 186

Primary Examiner — Sandra S Snapp
Assistant Examiner — Katherine Glennon
(74) *Attorney, Agent, or Firm* — Taft Stettinius & Hollister LLP

CPC G04B 19/00; G04B 19/025; G04B 19/04;
G04B 19/046; G04B 19/048; G04B
19/06; G04B 19/08; G04B 19/085; G04B
19/087; G04B 45/0069; G04B 45/0076;
G04B 19/065; G04B 19/082; G04B
19/10; G04B 19/103; G04B 19/106;
G04B 19/12; G04B 19/16; G04B 19/163;
G04B 19/166; G04B 19/18; G04B 19/22;
G04B 19/223; G04B 19/225; G04B
19/226; G04B 19/228; G04B 27/00;
G04B 27/06

(57) **CLAIM**

The ornamental design for a pocket watch, as shown and described.

See application file for complete search history.

DESCRIPTION

(56) **References Cited**

U.S. PATENT DOCUMENTS

1,085,857 A * 2/1914 Fitch G04B 3/045
224/164
D67,694 S * 6/1925 Foster D10/131

FIG. 1 is a front elevational view of a pocket watch showing my new design;
FIG. 2 is a back elevational view thereof;
FIG. 3 is a right side elevational view thereof;
FIG. 4 is a left side elevational view thereof;
FIG. 5 is a bottom plan view thereof;
FIG. 6 is a top plan view thereof; and,
FIG. 7 is a front, right side perspective view thereof.

1 Claim, 1 Drawing Sheet

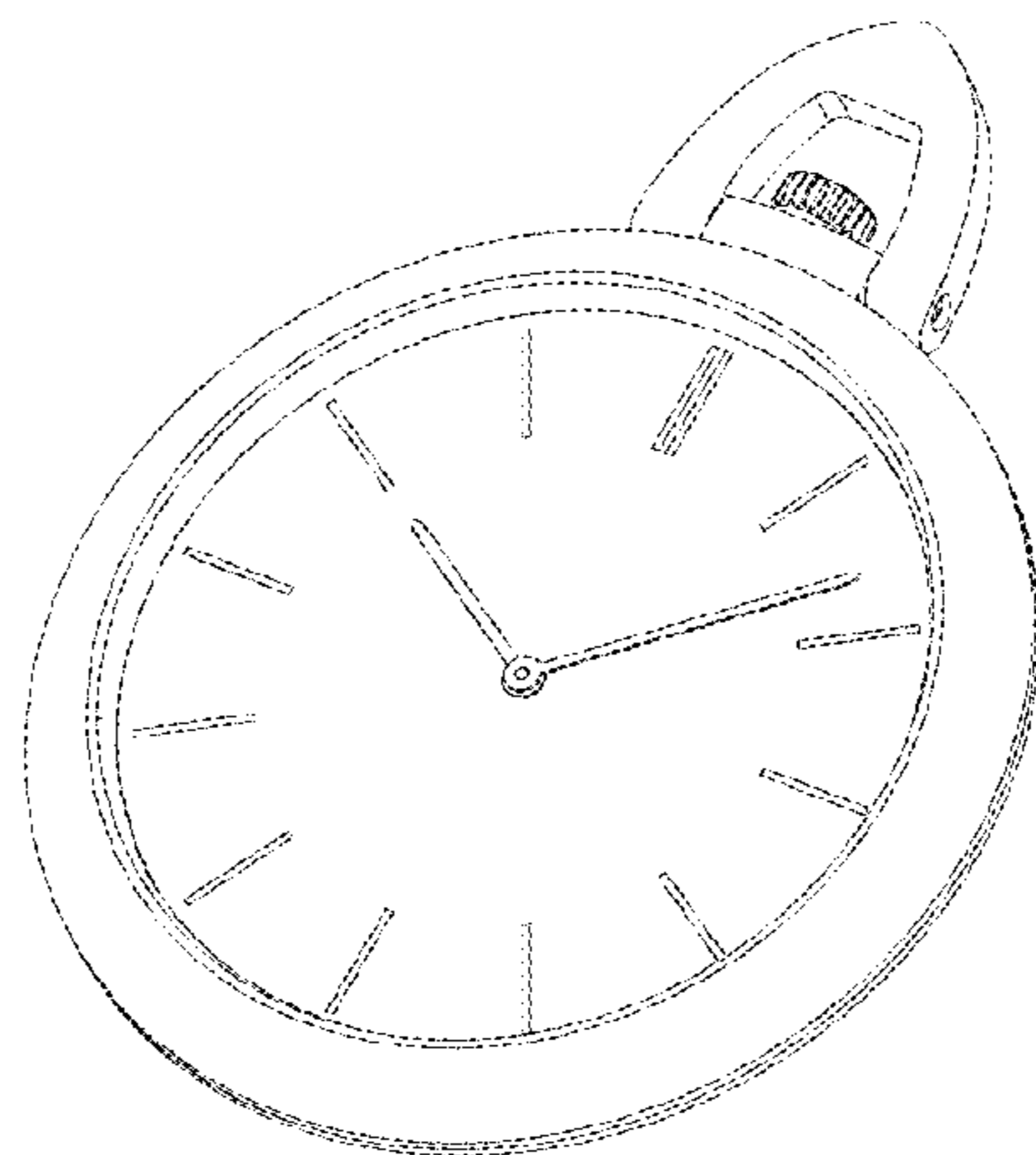

(56)

References Cited

U.S. PATENT DOCUMENTS

D173,724 S	*	12/1954	Ducommun	D10/30
D259,106 S	*	5/1981	Day	D10/31
D276,506 S	*	11/1984	Henkels	D10/23
D278,037 S	*	3/1985	Hattori	D10/30
D278,039 S	*	3/1985	Sakai	D10/37
D318,625 S	*	7/1991	Stowell	368/10
D324,655 S	*	3/1992	Bulgari	D10/30
D324,826 S	*	3/1992	Aulenti	D10/30
D398,544 S	*	9/1998	Lai	D10/31
D414,433 S	*	9/1999	Crow	D10/30
D649,069 S	*	11/2011	Galli	D10/30
D802,446 S	*	11/2017	El Alej	D10/30

OTHER PUBLICATIONS

Vintage Oris 17 Pocket Watch | posted at ebay.com n.d. © 1995-2018 eBay Inc.[online][site visited Mar. 28, 2018]. Available from Internet: <<https://www.ebay.co.uk/itm/VINTAGE-ORIS-17-JEWEL-GOLD-PLATED-POCKET-WATCH-IN-GOOD-WORKING-ORDER-/162957330511>>.*

IWC Ref 5205 Pocketwatch | posted at watchesandart.com Feb. 2014 © 2017 Watches and Art [online][site visited Mar. 28, 2018]. Available from Internet: <<http://www.watchesandart.com/iwc-ref-5240-minute-repeater-a-truly-rare-bird/>> (Year: 2014).*

IWC Pocket Watch 1962 | posted at ebay.com; Auction end date Oct. 2015, Watch c. 1962 © 1995-2018 eBay Inc. [online][site visited Mar. 28, 2018]. Available from Internet: <<https://www.ebay.ie/itm/252123595898>> (Year: 1962).*

* cited by examiner

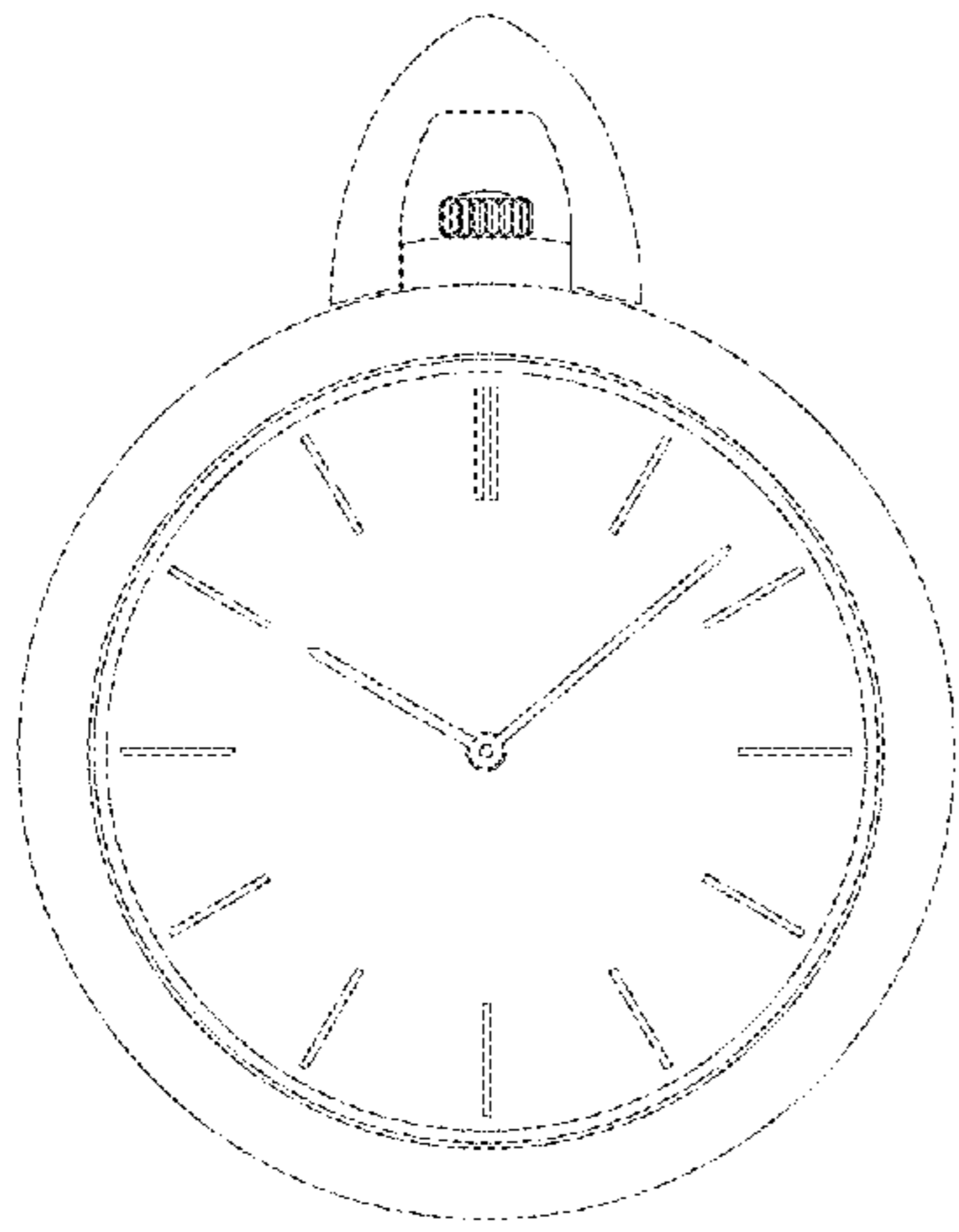

Fig. 1

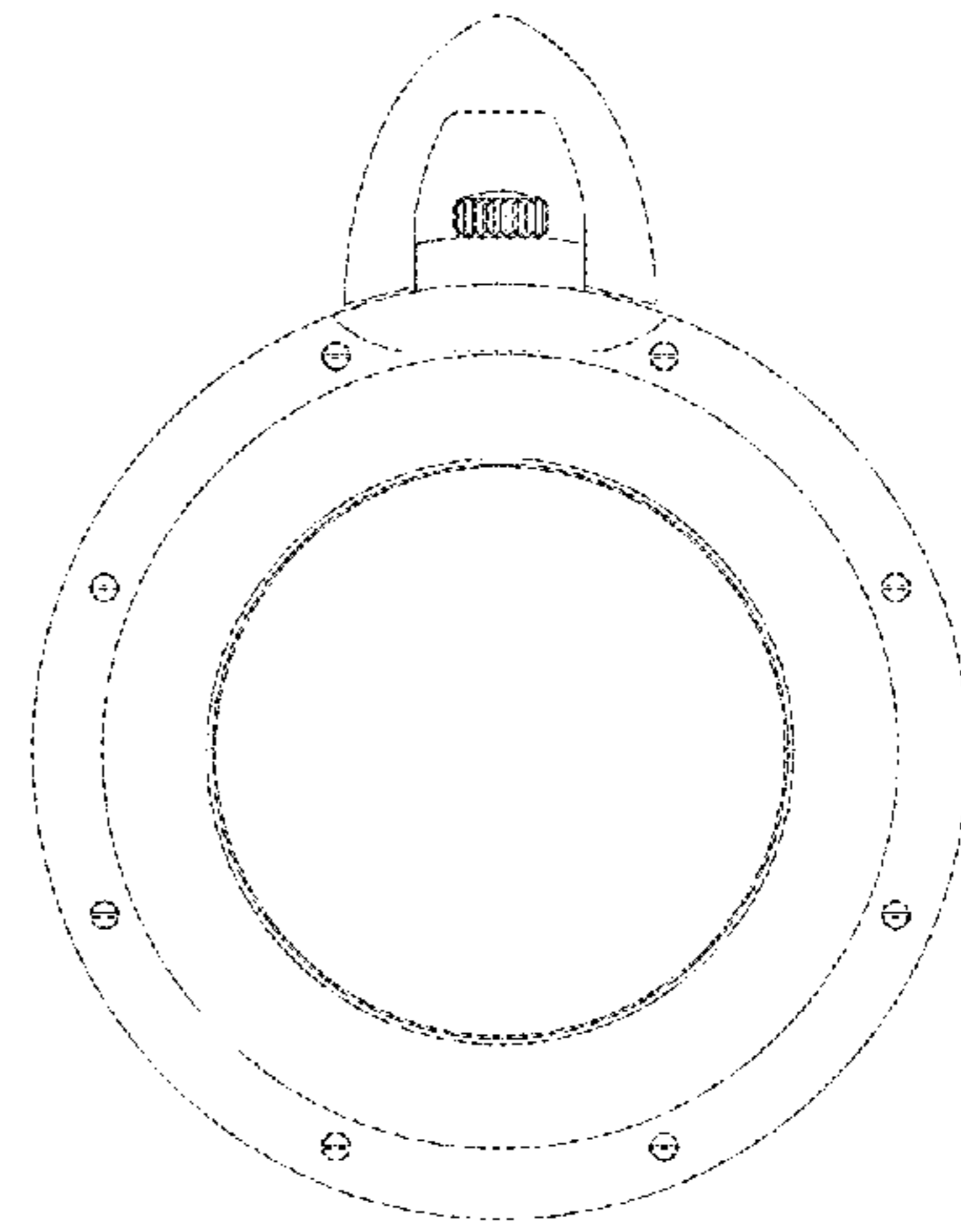

Fig. 2

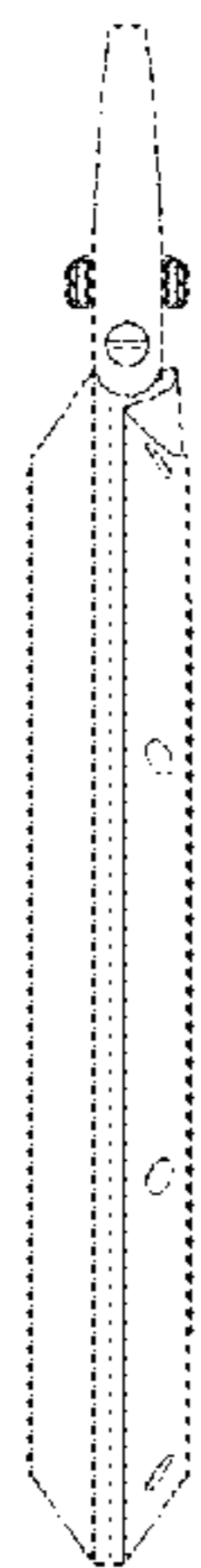

Fig. 3

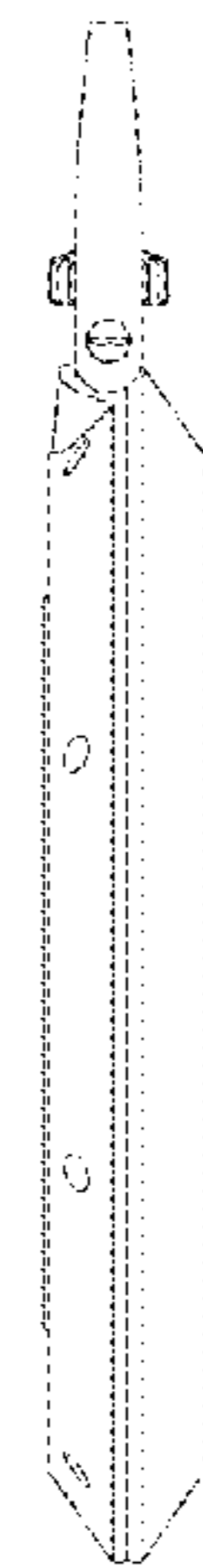

Fig. 4



Fig. 5

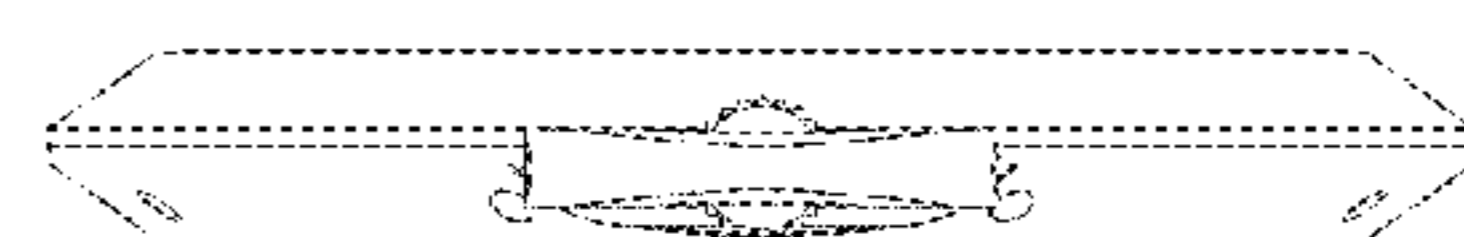

Fig. 6

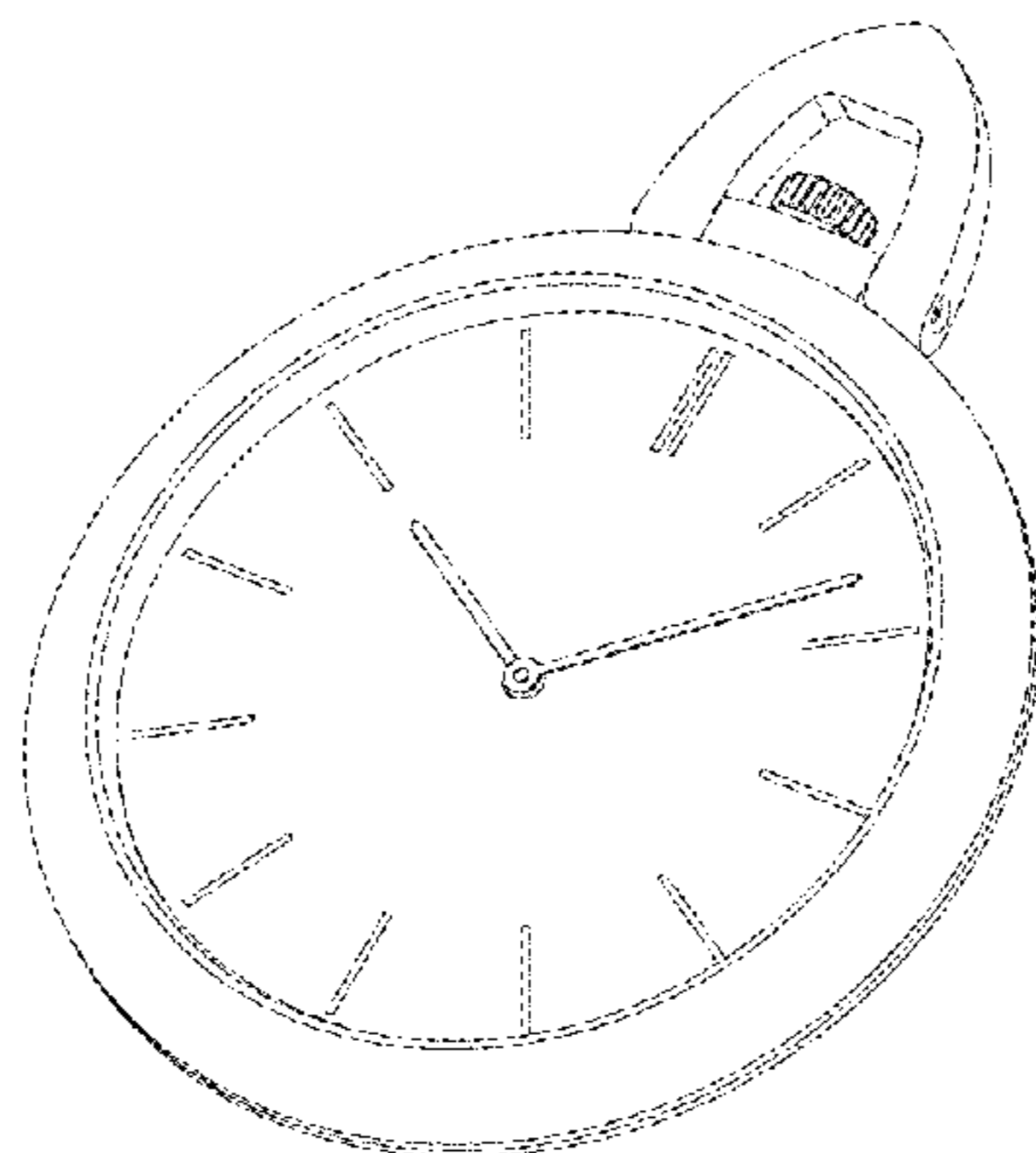

Fig. 7