



US00D827446S

(12) **United States Design Patent** (10) **Patent No.:** **US D827,446 S**  
**Arzano et al.** (45) **Date of Patent:** **\*\* \*Sep. 4, 2018**

(54) **CONTAINER WITH LID AND LABEL**

(71) Applicant: **Conopco, Inc.**, Englewood Cliffs, NJ (US)

(72) Inventors: **Victoria Louise Arzano**, New York, NY (US); **Randi Lynn Silberman**, Brooklyn, NY (US)

(73) Assignee: **CONOPCO, INC.**, Englewood Cliffs, NJ (US)

(\*) Notice: This patent is subject to a terminal disclaimer.

(\*\*) Term: **15 Years**

(21) Appl. No.: **29/593,364**

(22) Filed: **Feb. 8, 2017**

(30) **Foreign Application Priority Data**

Aug. 17, 2016 (EM) ..... 003344274-0001

(51) **LOC (11) Cl.** ..... **09-01**

(52) **U.S. Cl.**  
USPC ..... **D9/563; D9/575**

(58) **Field of Classification Search**

USPC ..... D3/203.1; D20/22, 27, 37; D9/416, 454, D9/499, 516, 518, 560, 563, 570-575, D9/901; D24/121, 224; D4/114  
CPC ..... B65D 2501/0081; B65D 25/205; B65D 41/3447; B65D 23/14  
See application file for complete search history.

(56) **References Cited**

**U.S. PATENT DOCUMENTS**

D185,514 S \* 6/1959 Ryan ..... D20/22  
5,544,768 A \* 8/1996 Gargione ..... B65D 50/046  
215/209  
D382,488 S \* 8/1997 Ja ..... D9/560  
5,803,287 A \* 9/1998 Kusz ..... B65D 41/0471  
215/330  
D399,756 S \* 10/1998 Lonczak ..... D9/574

D499,452 S \* 12/2004 Walsh ..... D20/22  
D503,620 S \* 4/2005 Taylor ..... D9/518  
D535,566 S \* 1/2007 Lin ..... D9/453  
D548,607 S \* 8/2007 Langbein ..... D9/454  
D590,721 S \* 4/2009 Martinez De San Vicente .....  
D9/520

D602,785 S \* 10/2009 Rothberg ..... D9/547  
D691,054 S \* 10/2013 Olsson ..... D9/435

(Continued)

**OTHER PUBLICATIONS**

Co-pending application, Arzano et al., U.S. Appl. No. 29/593,344, filed Feb. 8, 2017, Transparent Container With Lid and Label.

(Continued)

*Primary Examiner* — Ian Simmons

*Assistant Examiner* — Keith Frank

(74) *Attorney, Agent, or Firm* — Foley & Lardner LLP

(57) **CLAIM**

An ornamental design for a container with lid and label, as shown and described.

**DESCRIPTION**

The patent or application file contains at least one drawing executed in color. Copies of this patent or patent application publication with color drawing(s) will be provided by the Office upon request and payment of the necessary fee.

FIG. 1 is a front and side perspective view of a container with lid and label showing our new design;

FIG. 2 is a front elevation view thereof;

FIG. 3 is a rear elevation view thereof;

FIG. 4 is a left side elevation view thereof;

FIG. 5 is a right side elevation view thereof; and,

FIG. 6 is a top plan view thereof.

The use of the color in the accompanying drawings is to be considered an integral part of the disclosed and claimed design.

**1 Claim, 6 Drawing Sheets**  
**(6 of 6 Drawing Sheet(s) Filed in Color)**

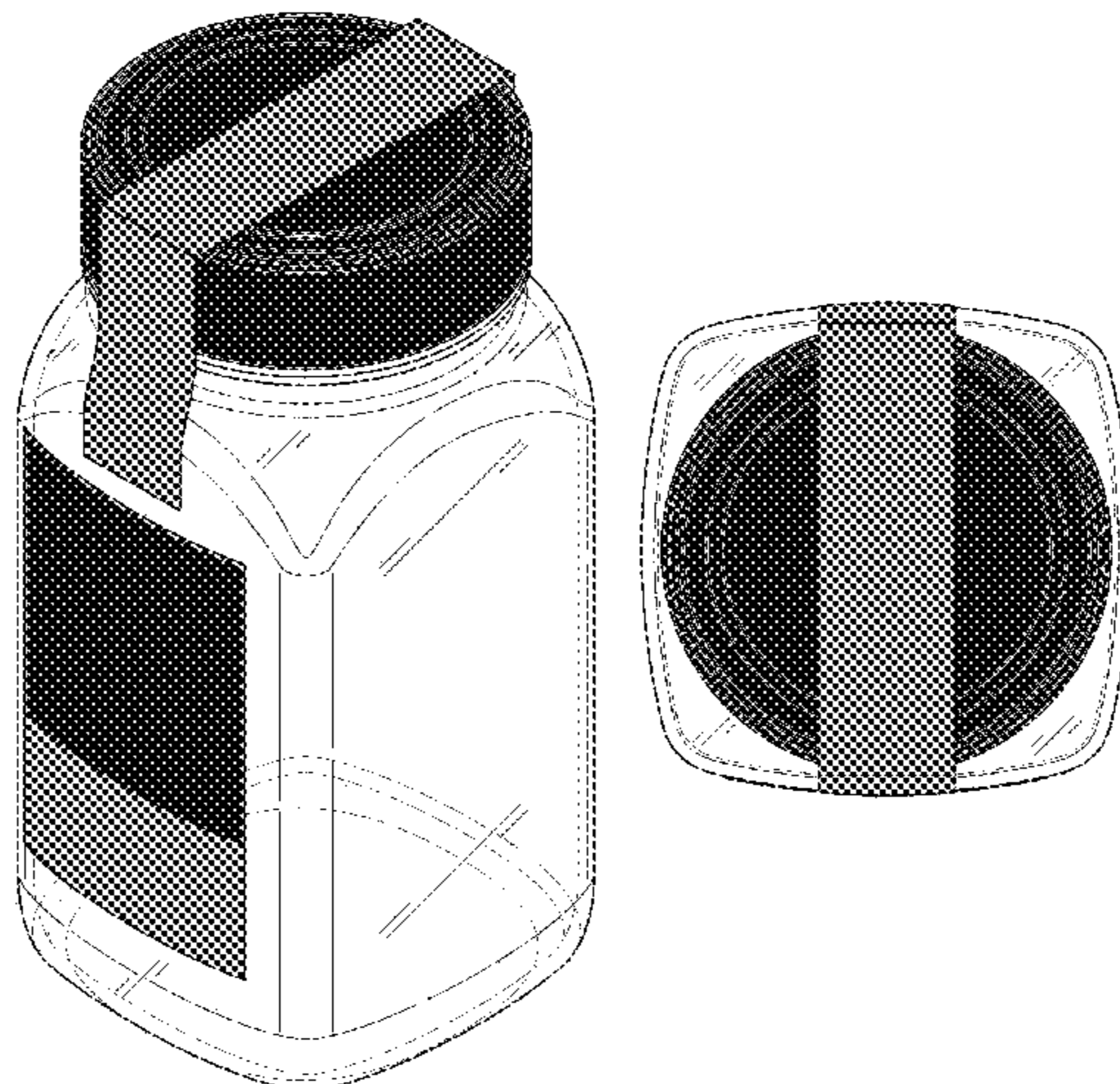

(56)

**References Cited**

U.S. PATENT DOCUMENTS

D707,297 S \* 6/2014 Hoang ..... D20/27  
 D717,661 S \* 11/2014 McIntire ..... D9/560  
 D756,234 S \* 5/2016 Orset ..... D9/560  
 D775,726 S \* 1/2017 Giancursio, II ..... D24/121  
 D781,378 S \* 3/2017 Miceli ..... D20/22  
 D798,160 S \* 9/2017 Miller ..... D9/560  
 2004/0007556 A1\* 1/2004 Manera ..... B65D 41/06  
 215/332  
 2011/0198838 A1\* 8/2011 Sellars ..... G09F 3/0288  
 283/81  
 2013/0126551 A1\* 5/2013 Unger ..... B01L 3/523  
 222/1  
 2013/0298435 A1\* 11/2013 Silvano ..... G09F 3/0289  
 40/638  
 2014/0068982 A1\* 3/2014 Silvano ..... G09F 3/0288  
 40/638  
 2016/0207045 A1\* 7/2016 Unger ..... B01L 3/523

OTHER PUBLICATIONS

Co-pending application, Arzano et al., U.S. Appl. No. 29/593,349, filed Feb. 8, 2017, Transparent Container With Lid and Coloured Label.

Co-pending application, Arzano et al., U.S. Appl. No. 29/593,353, filed Feb. 8, 2017, Transparent Container With Lid and Coloured Label.

Co-pending application, Arzano et al., U.S. Appl. No. 29/593,354, filed Feb. 8, 2017, Transparent Container With Lid and Coloured Label.

Co-pending application, Arzano et al., U.S. Appl. No. 29/593,356, filed Feb. 8, 2017, Transparent Container With Lid and Coloured Label.

Co-pending application, Arzano et al., U.S. Appl. No. 29/593,360, filed Feb. 8, 2017, Transparent Container with Lid and Coloured Label.

Co-pending application, Arzano et al., U.S. Appl. No. 29/593,361, filed Feb. 8, 2017, Transparent Container With Lid and Coloured Label.

Co-pending application, Arzano et al., U.S. Appl. No. 29/593,362, filed Feb. 8, 2017, Transparent Container With Lid and Coloured Label.

Co-pending application, Arzano et al., U.S. Appl. No. 29/593,367, filed Feb. 8, 2017, Transparent Container With Lid and Coloured Label.

\* cited by examiner



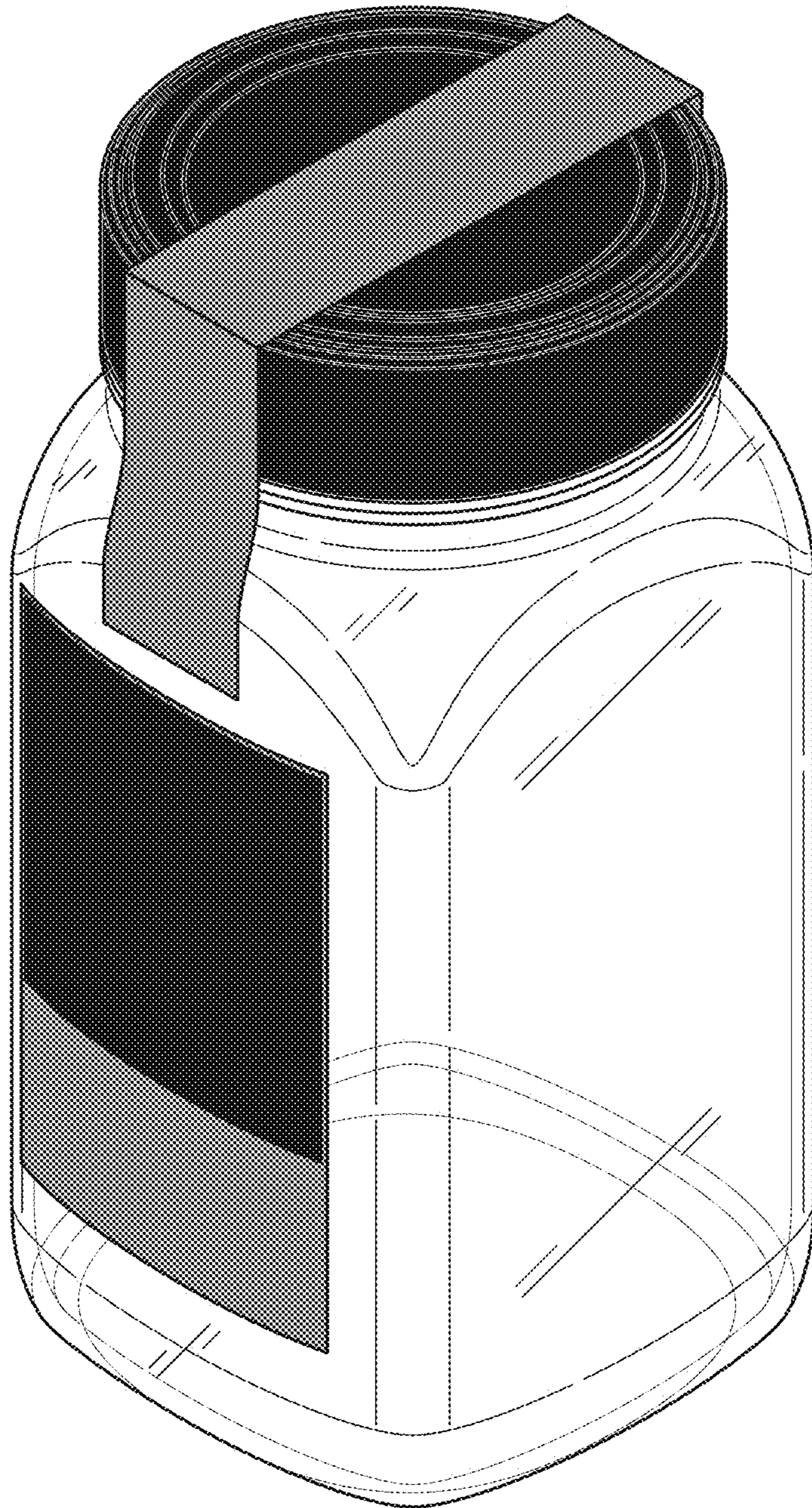

Fig. 1

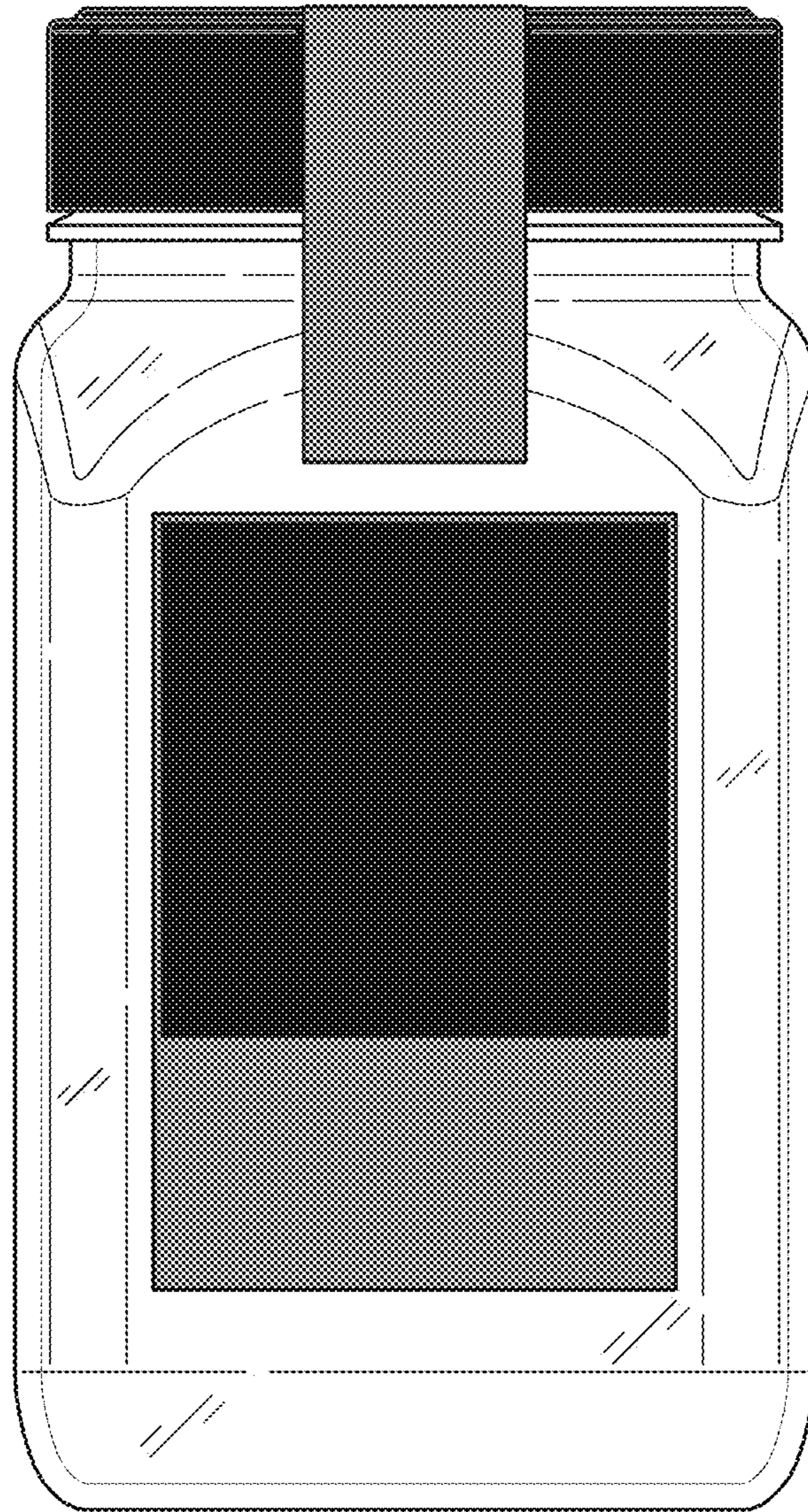

Fig. 2

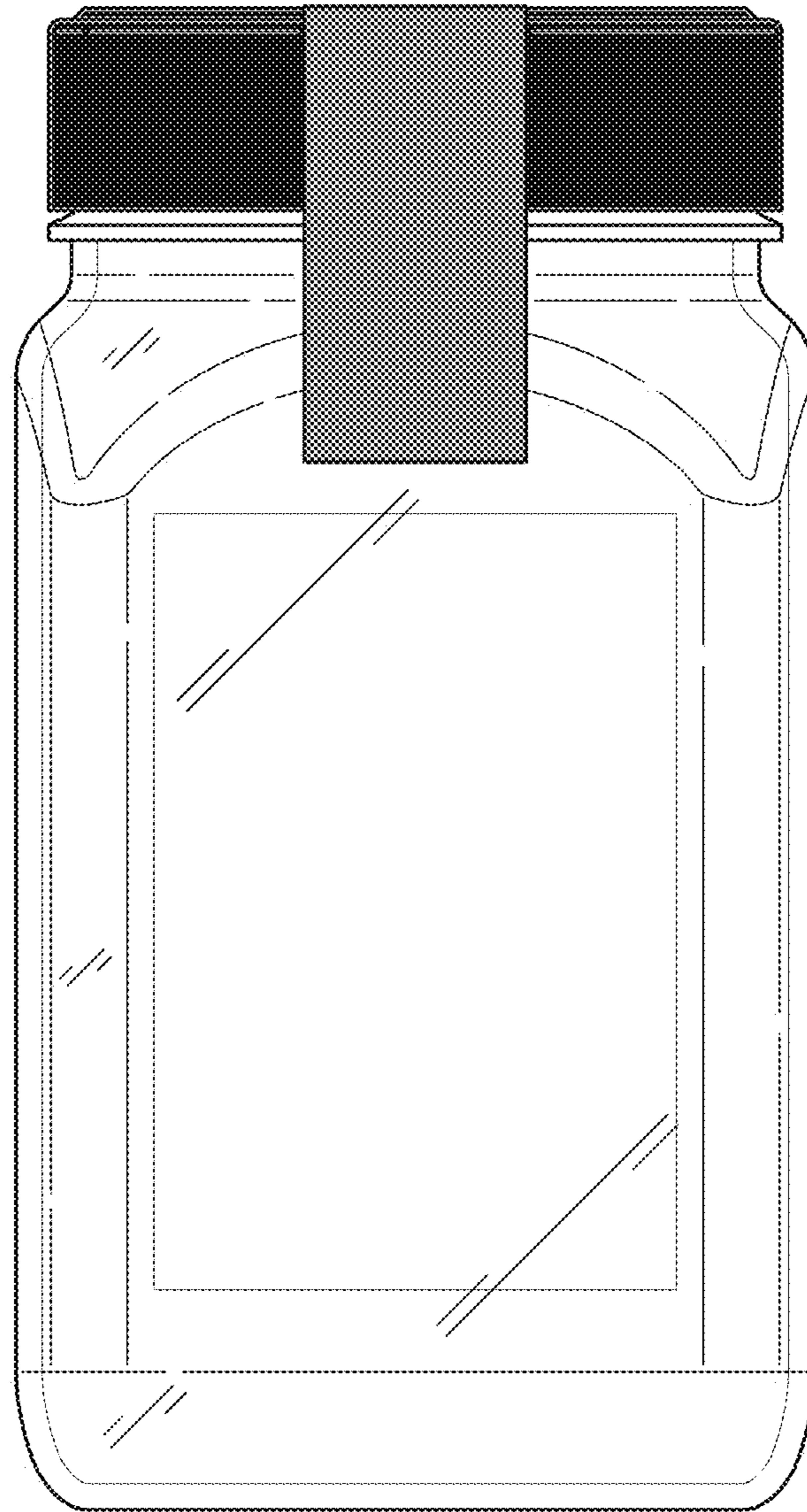

Fig. 3



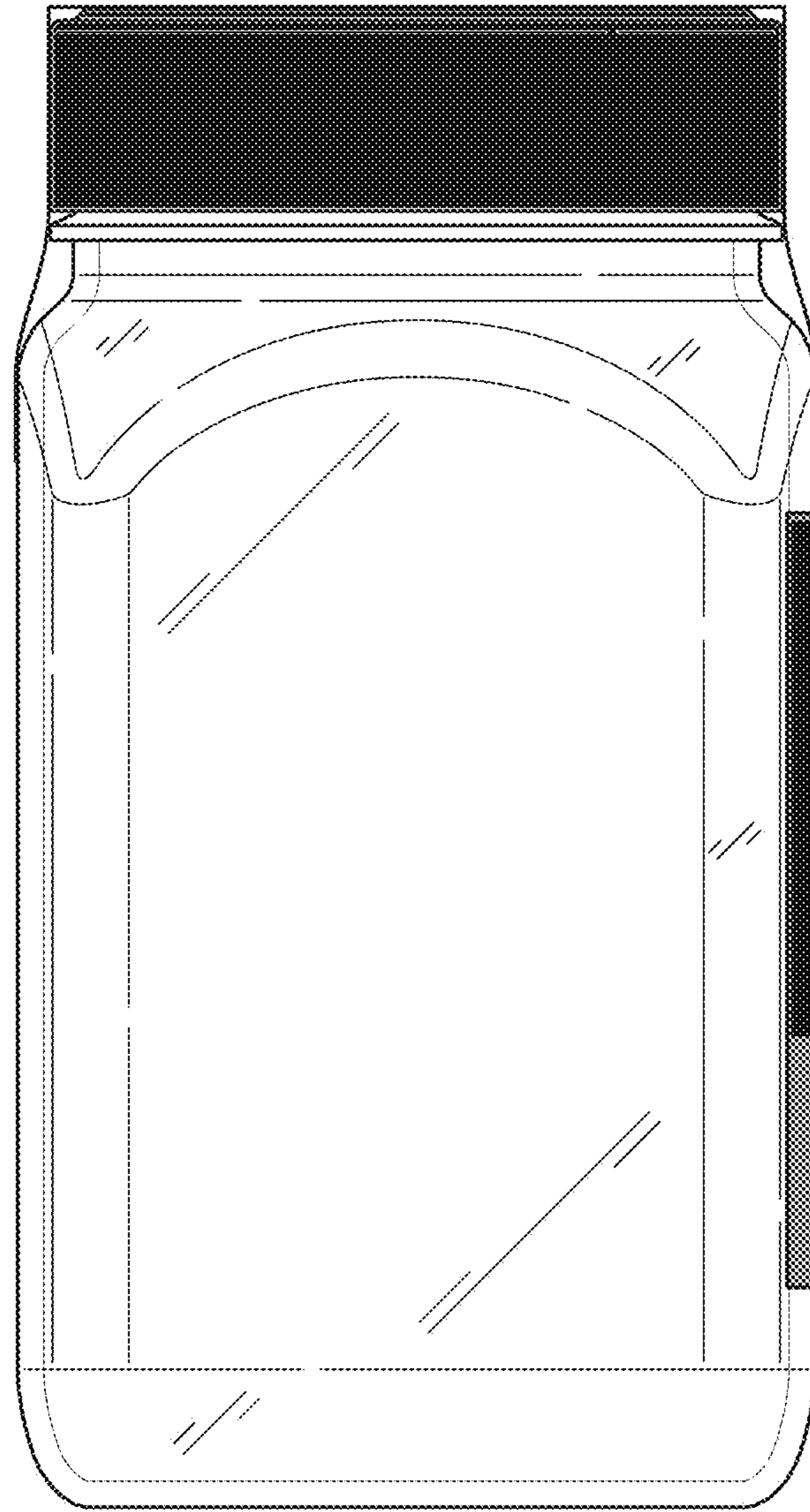

Fig. 4

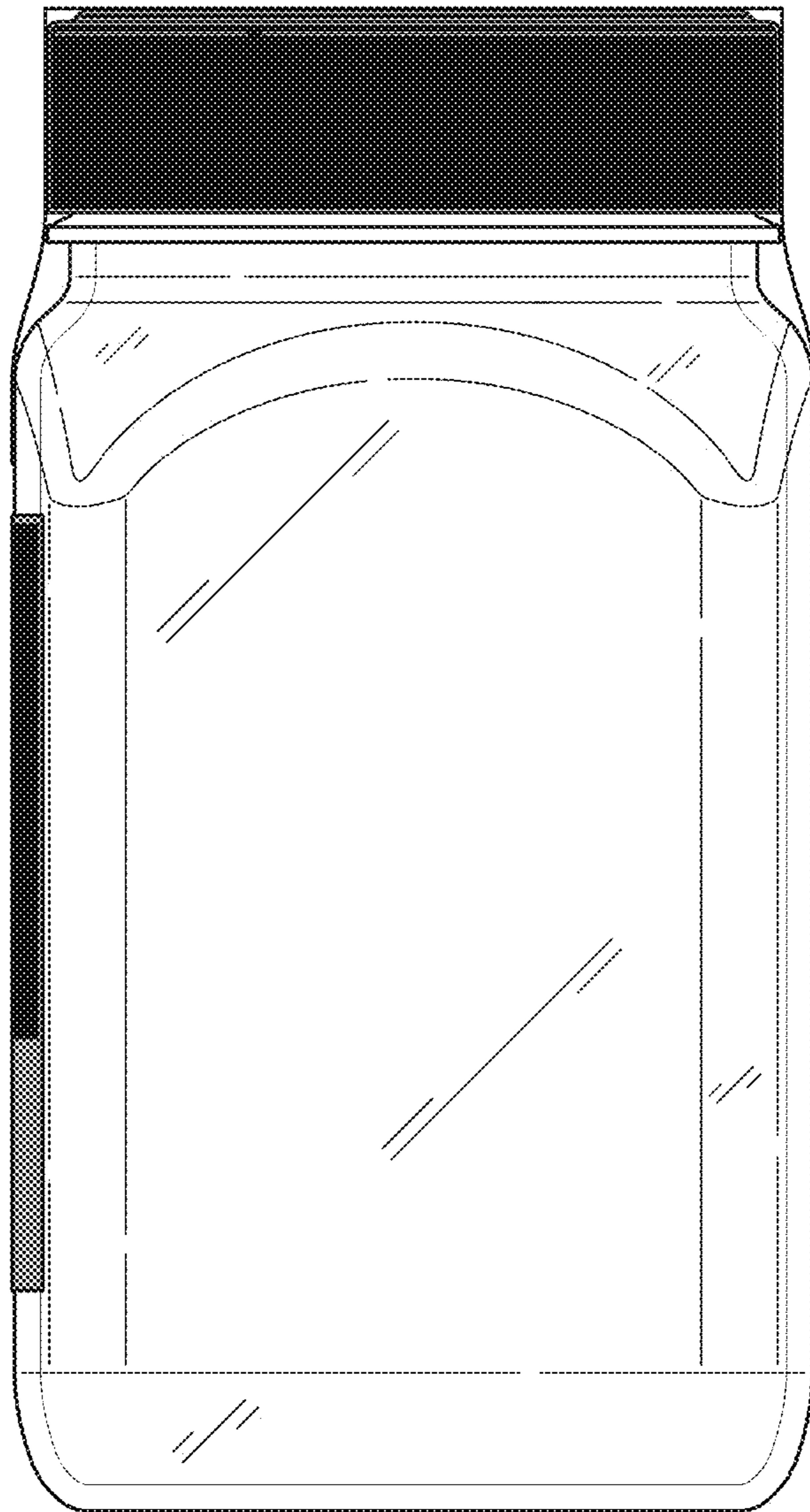

Fig. 5

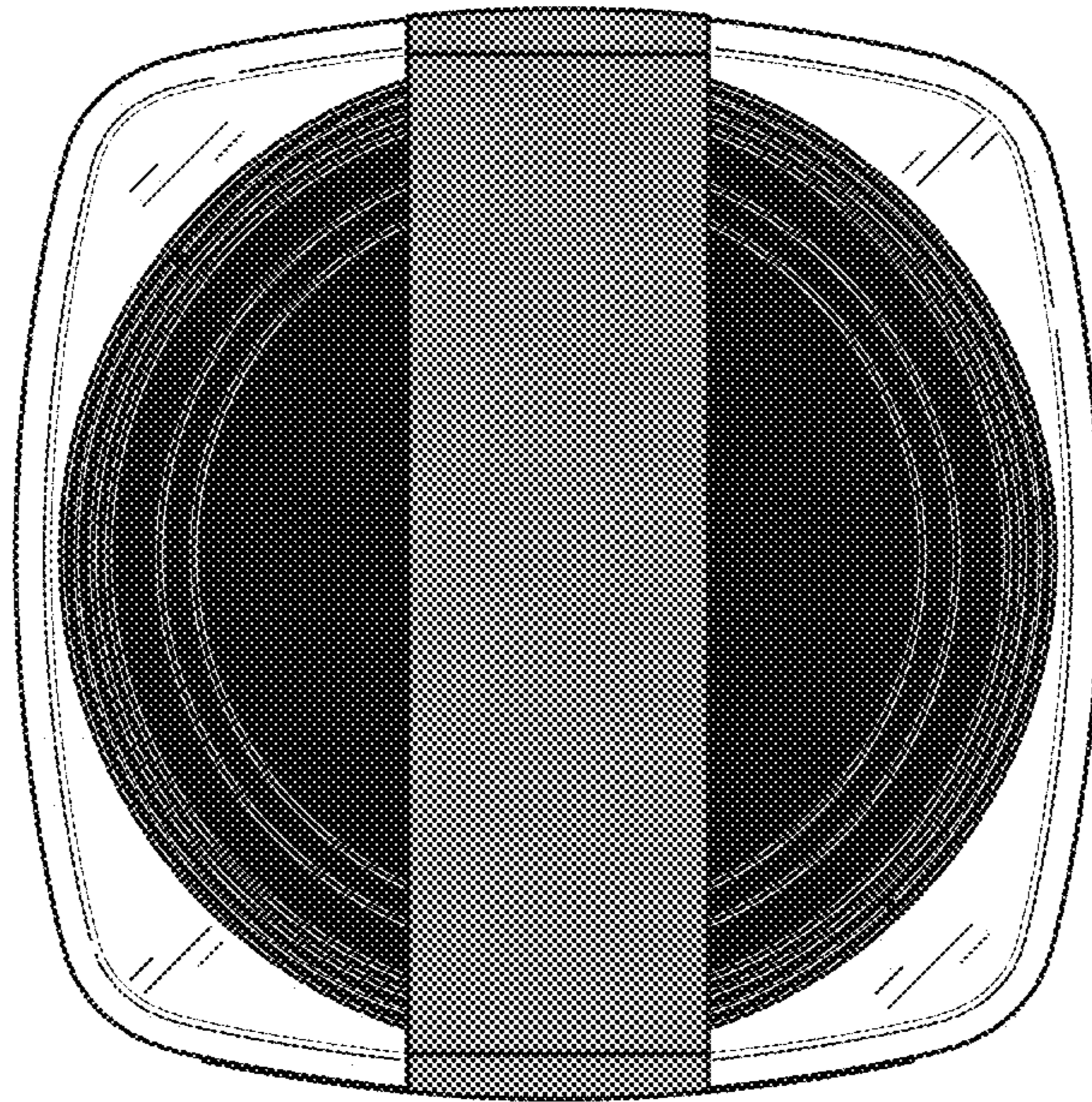

Fig. 6