



US00D827444S

(12) **United States Design Patent** (10) **Patent No.:** **US D827,444 S**  
**Oates** (45) **Date of Patent:** **\*\* Sep. 4, 2018**

(54) **BOTTLE**

(71) Applicant: **Conopco, Inc.**, Englewood Cliffs, NJ (US)

(72) Inventor: **Benjamin Phelan Oates**, Tunbridge Wells (GB)

(73) Assignee: **Conopco, Inc.**, Englewood Cliffs, NJ (US)

(\*\*) Term: **15 Years**

(21) Appl. No.: **29/595,631**

(22) Filed: **Mar. 1, 2017**

(30) **Foreign Application Priority Data**

Sep. 7, 2016 (EM) ..... 003368414-0001

(51) **LOC (11) Cl.** ..... **09-01**

(52) **U.S. Cl.**  
USPC ..... **D9/543; D9/575**

(58) **Field of Classification Search**  
USPC ..... D9/516, 529-530, 543, 561, 575, 715, D9/719

CPC ..... B65D 1/00; B65D 1/02; B65D 1/0223  
See application file for complete search history.

(56) **References Cited**

**U.S. PATENT DOCUMENTS**

D348,840 S *	7/1994	Kuzma	.....	D9/575
D445,037 S *	7/2001	Kokenge	.....	D9/529
D451,402 S *	12/2001	Kokenge	.....	D9/549
D471,820 S	3/2003	Faillant-Dumas		
D495,957 S	9/2004	Bakic		
D527,641 S	9/2006	Bakic		
D532,309 S *	11/2006	Stolle	.....	D9/529
D548,601 S	8/2007	Mongeon et al.		
D563,233 S	3/2008	Patzak		
D575,166 S	8/2008	Miller et al.		

D591,613 S	5/2009	Mason		
D597,411 S	8/2009	Colatrella et al.		
D601,425 S	10/2009	Miller et al.		
D604,164 S	11/2009	Miller et al.		
D632,585 S *	2/2011	Jebb	.....	D9/682
D641,633 S	7/2011	Carnduff et al.		
D646,170 S	10/2011	Carnduff et al.		
D646,979 S *	10/2011	Shaw	.....	D9/542
D659,008 S *	5/2012	Gately	.....	D9/447
D666,501 S *	9/2012	Brummelhuis	.....	D9/694
D696,123 S *	12/2013	Brummelhuis	.....	D9/516
D714,153 S	9/2014	Brewer et al.		
D726,541 S	4/2015	Xu		

(Continued)

**OTHER PUBLICATIONS**

Co-Pending Application, Benjamin Phelan Oates, U.S. Appl. No. 29/596,260, filed Mar. 7, 2017.

(Continued)

*Primary Examiner* — Dana L Meyrow

(74) *Attorney, Agent, or Firm* — Karen E. Klumas

(57) **CLAIM**

The ornamental design for a bottle, as shown and described.

**DESCRIPTION**

FIG. 1 is a top, front and side perspective view of a bottle in accordance with my new design;  
FIG. 2 is a front elevational view thereof;  
FIG. 3 is a rear elevational view thereof;  
FIG. 4 is a left side elevational view thereof;  
FIG. 5 is a right side elevational view thereof;  
FIG. 6 is a top plan view thereof; and,  
FIG. 7 is a bottom plan view thereof.  
The evenly-dashed broken lines in the drawings illustrate the portions of the bottle that form no part of the claim. The dot-dash broken lines in the drawings define the bounds of the claim and form no part thereof.

**1 Claim, 4 Drawing Sheets**

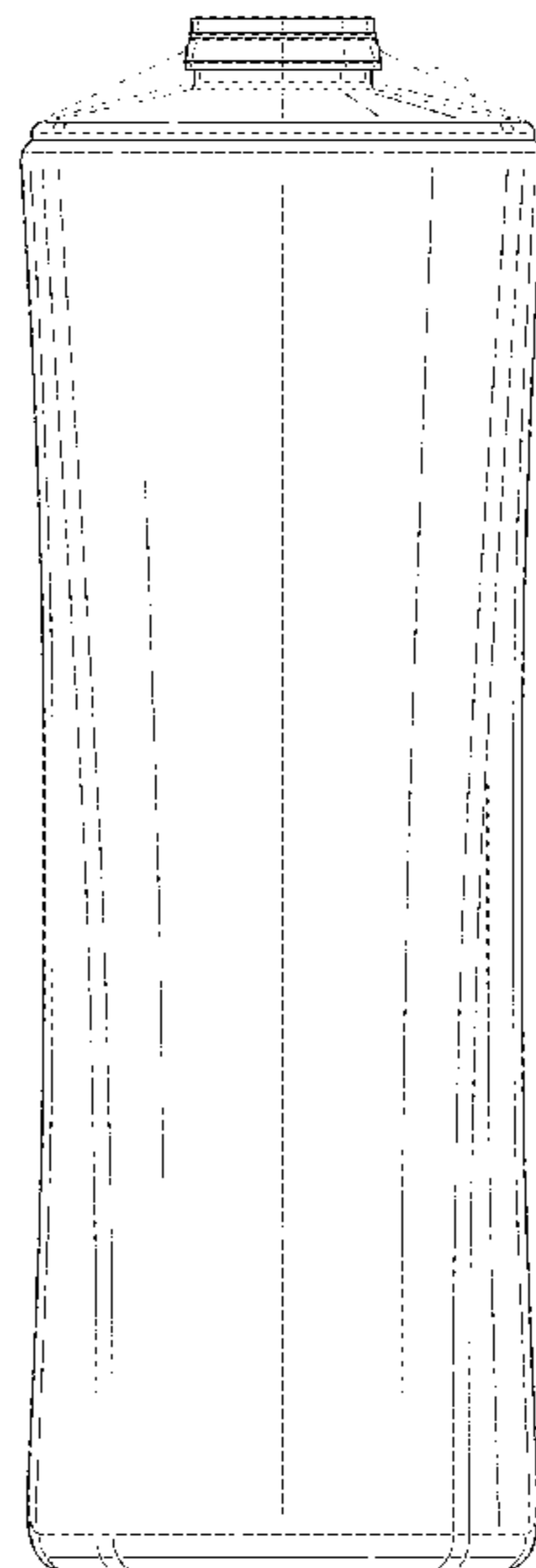
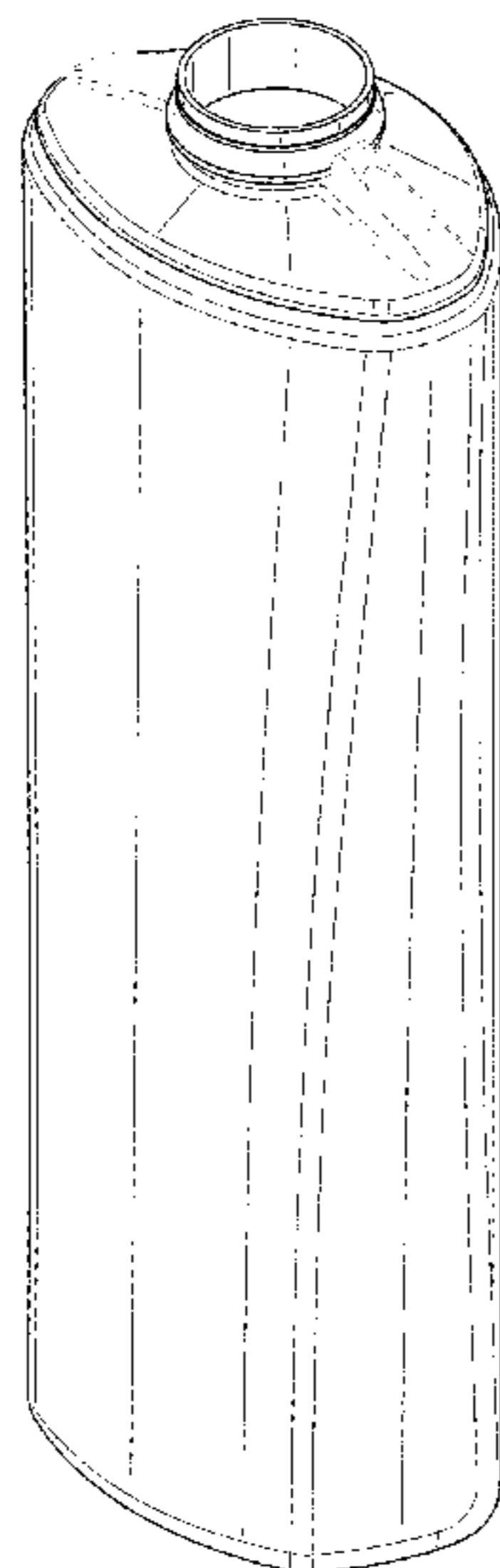

(56)

**References Cited**

U.S. PATENT DOCUMENTS

D726,542 S	*	4/2015	Xu .....	D9/521
D741,192 S	*	10/2015	Snyder .....	D9/561
D746,692 S	*	1/2016	Alvarez de Cienfuegos Hernandez .....	D9/521
D748,491 S	*	2/2016	Jin .....	D9/682
D750,964 S	*	3/2016	Alvarez de Cienfuegos Hernandez .....	D9/521
D751,911 S	*	3/2016	Alvarez de Cienfuegos Hernandez .....	D9/521
D761,657 S		7/2016	Gotur et al.	
D776,540 S	*	1/2017	Jin .....	D9/520
D776,541 S	*	1/2017	Jin .....	D9/520
D792,232 S		7/2017	Miller et al.	
D801,824 S	*	11/2017	Marotti .....	D9/575

OTHER PUBLICATIONS

Co-Pending Application, Benjamin Phelan Oates, U.S. Appl. No. 29/596,266, filed Mar. 7, 2017.

Co-Pending Application, Benjamin Phelan Oates, U.S. Appl. No. 29/596,536, filed Mar. 9, 2017.

Co-Pending Application, Benjamin Phelan Oates, U.S. Appl. No. 29/596,546, filed Mar. 9, 2017.

Co-Pending Application, Benjamin Phelan Oates, U.S. Appl. No. 29/596,547, filed Mar. 9, 2017.

Co-Pending Application, Benjamin Phelan Oates, U.S. Appl. No. 29/597,562, filed Mar. 17, 2017.

\* cited by examiner

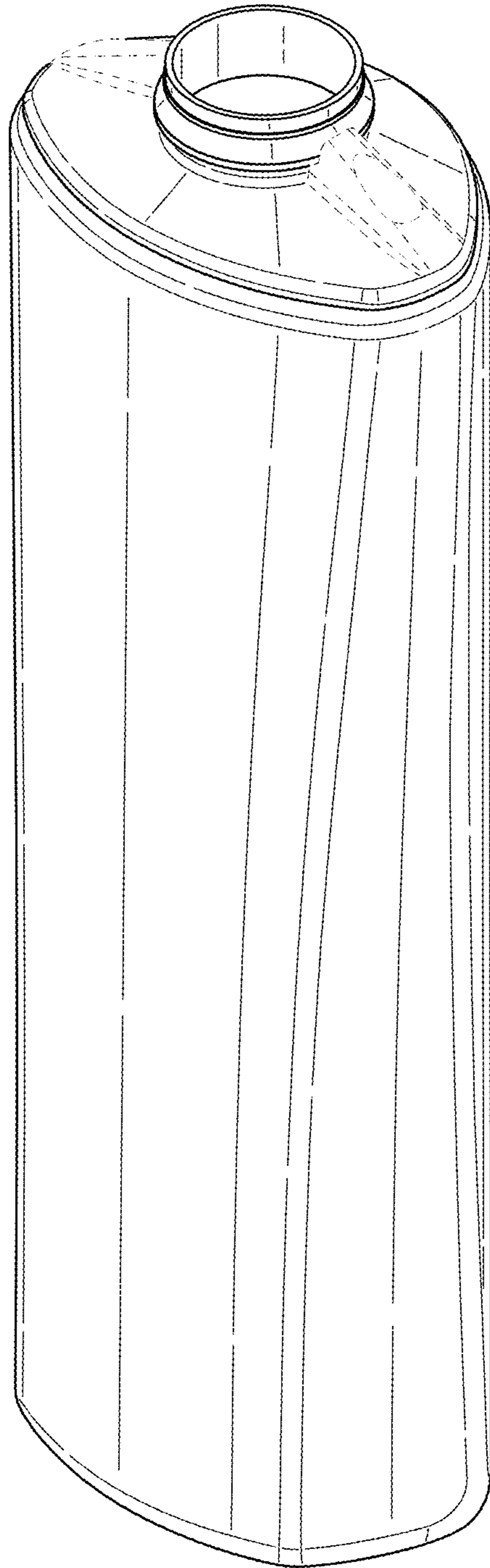

Fig. 1

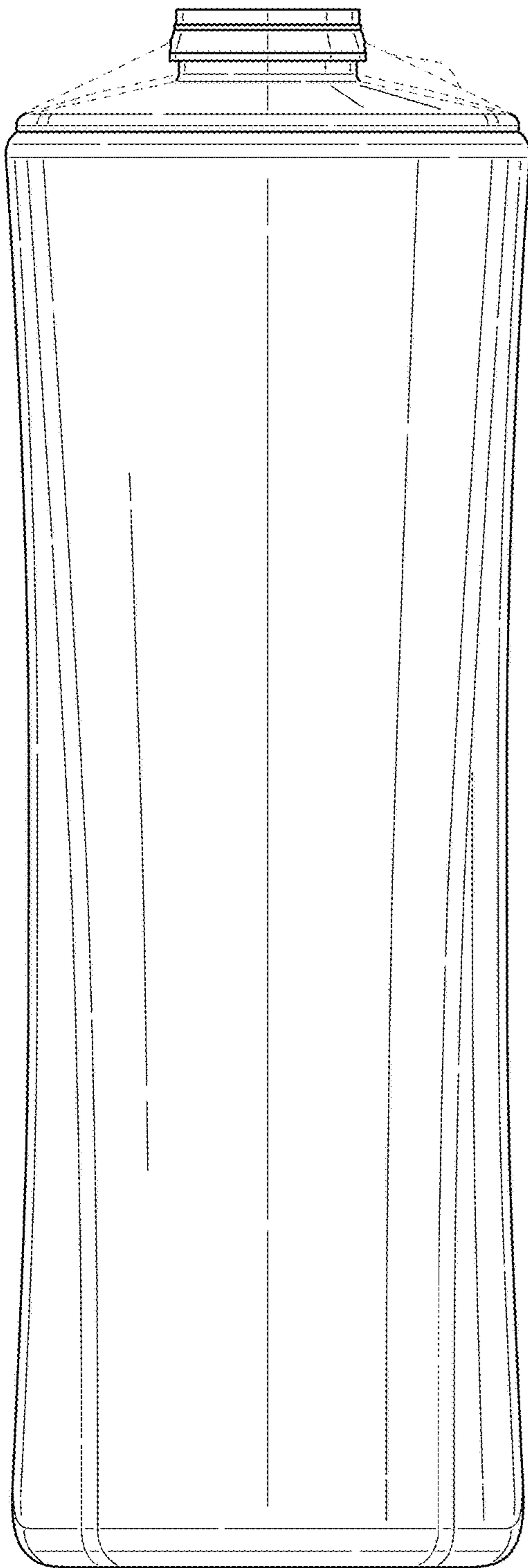

Fig. 2

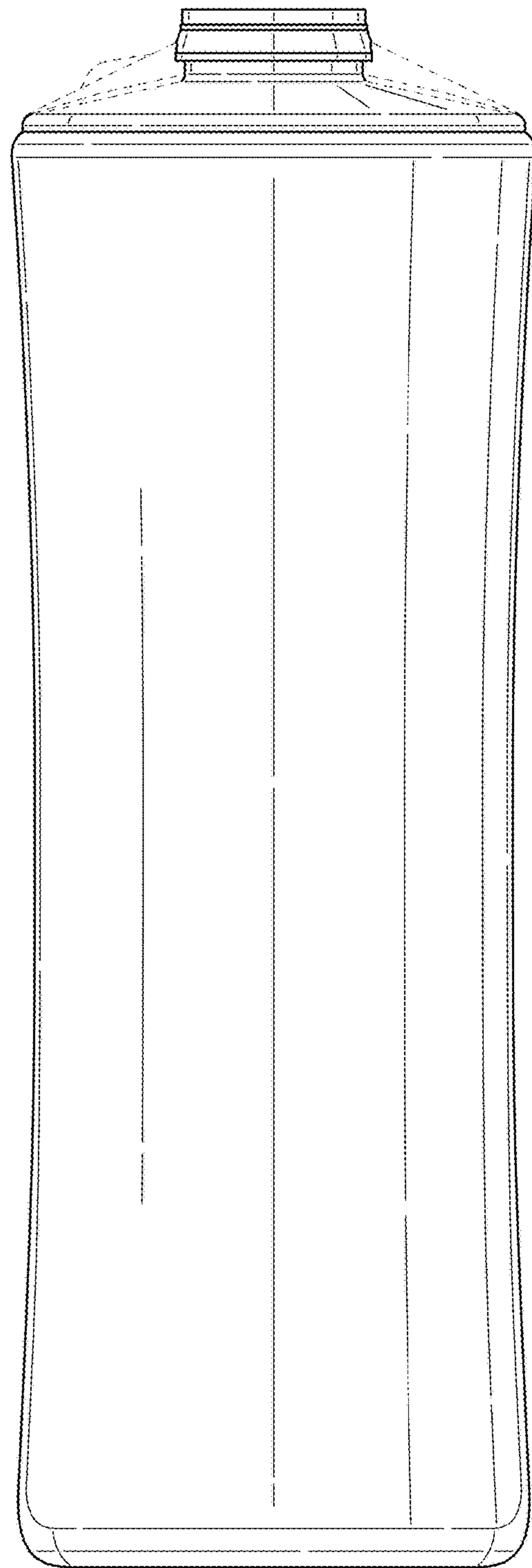

Fig. 3

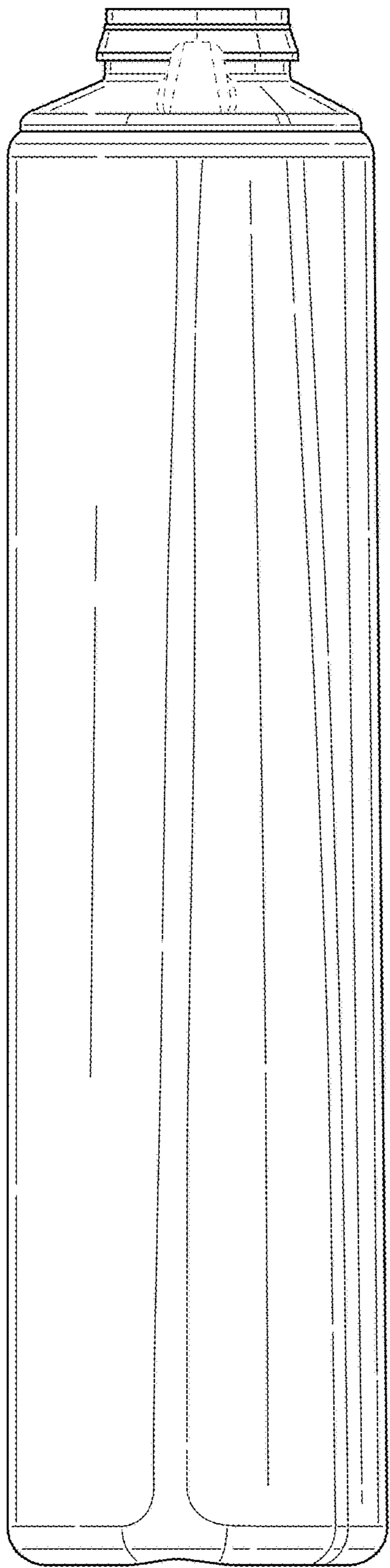

Fig. 4

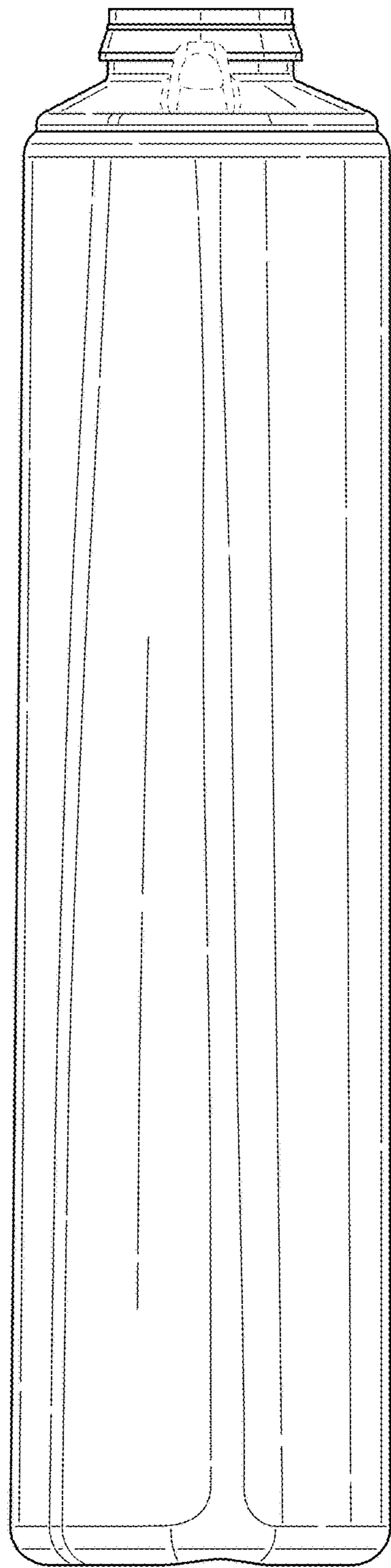

Fig. 5

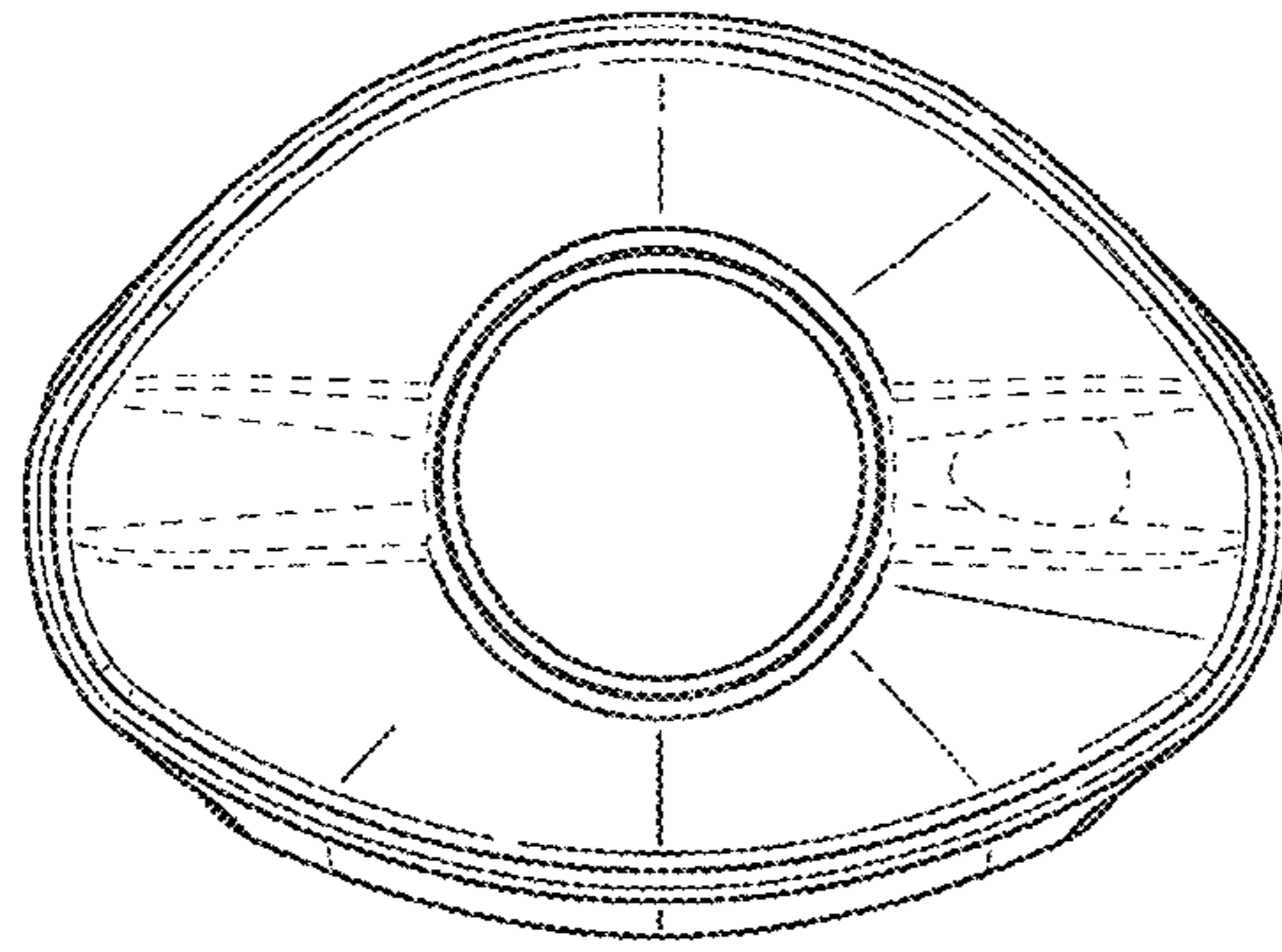

Fig. 6

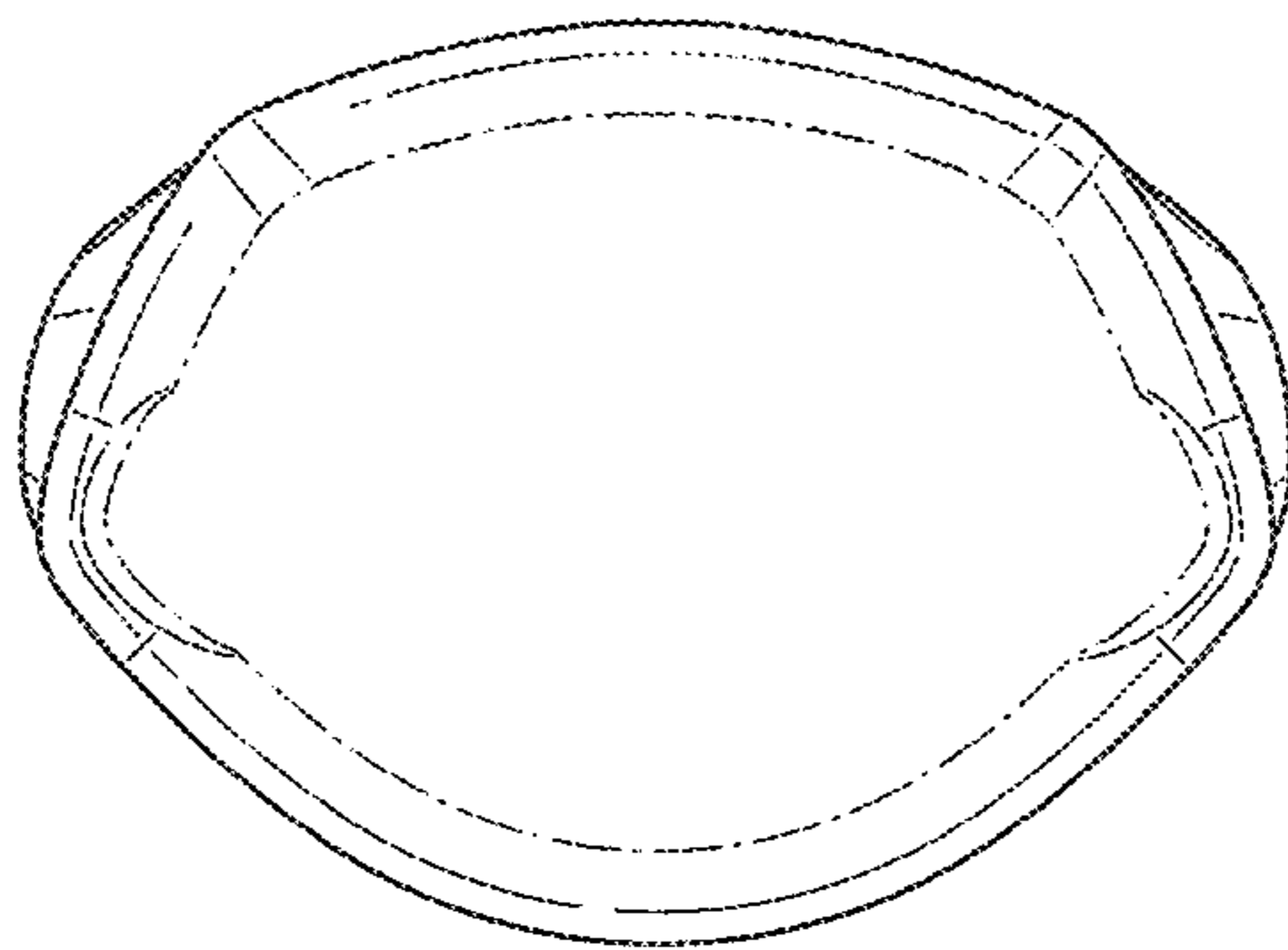

Fig. 7