



US00D827378S

(12) **United States Design Patent** (10) **Patent No.:** **US D827,378 S**
Mulhauser et al. (45) **Date of Patent:** **** Sep. 4, 2018**

(54) **TUMBLER**
(71) Applicant: **Silver Buffalo, LLC**, New York, NY (US)
(72) Inventors: **Paul Mulhauser**, New York, NY (US); **Lyndon Treacy**, Brooklyn, NY (US); **Eric Silver**, New York, NY (US)
(73) Assignee: **The Boeing Company**, Chicago, IL (US)
(**) Term: **15 Years**

D439,473 S 3/2001 Lin
6,216,909 B1 4/2001 Lin
D446,687 S * 8/2001 Furman D7/509
D454,278 S * 3/2002 Kerman D7/509
D469,658 S 2/2003 Norris
D476,193 S 6/2003 Janky
D478,779 S 8/2003 Stamper
D482,238 S 11/2003 Lin
D483,995 S * 12/2003 Otake D7/523
D488,672 S 4/2004 Oas
6,718,664 B2 4/2004 Williams
D489,574 S 5/2004 Copeland
D494,010 S 8/2004 Yuen

(Continued)

(21) Appl. No.: **29/605,187**
(22) Filed: **May 24, 2017**
(51) **LOC (11) Cl.** **07-01**
(52) **U.S. Cl.**
USPC **D7/523; D7/532**
(58) **Field of Classification Search**
USPC D7/507, 509, 510, 511, 523, 529, 531, D7/532, 533, 535, 536, 508, 392.1, 396.2, D7/387, 543, 608; D8/33, 34; 220/592.16, 592.17, 295.03, 718, 719, 220/495.03, 62.12, 710.5; D9/517, 567, D9/554, 555, 558, 503, 504, 552, 540, D9/454
CPC .. B25B 13/52; B67B 7/00; B67B 7/14; B67B 7/16; A47G 19/22; A47G 19/2227; A45F 3/20
See application file for complete search history.

OTHER PUBLICATIONS

YETI 30 oz. Rambler Tumbler Cup, printed from www.dickssportinggoods.com on Apr. 13, 2016.

(Continued)

Primary Examiner — Marianne Pandozzi
Assistant Examiner — Jae Liang
(74) *Attorney, Agent, or Firm* — Ostrager Chong Flaherty & Broitman PC

(57) **CLAIM**

We claim the ornamental design for a tumbler, as shown and described.

DESCRIPTION

FIG. 1 is a top, front and right side perspective view of a tumbler showing our new design;
FIG. 2 is a top view thereof;
FIG. 3 is a side view thereof, all side views being the same;
FIG. 4 is a bottom view thereof; and,
FIG. 5 is an enlarged sectional view thereof taken along the line 5-5 in FIG. 2.
The broken lines in the drawings depict portions of the tumbler that form no part of the claimed design.

1 Claim, 3 Drawing Sheets

(56) **References Cited**
U.S. PATENT DOCUMENTS
5,427,269 A 6/1995 Willbrandt
5,433,337 A 7/1995 Willbrandt
5,449,089 A 9/1995 Turner
5,769,266 A 6/1998 Willbrandt
5,860,557 A 6/1999 Willbrandt
D438,757 S 3/2001 Joergensen

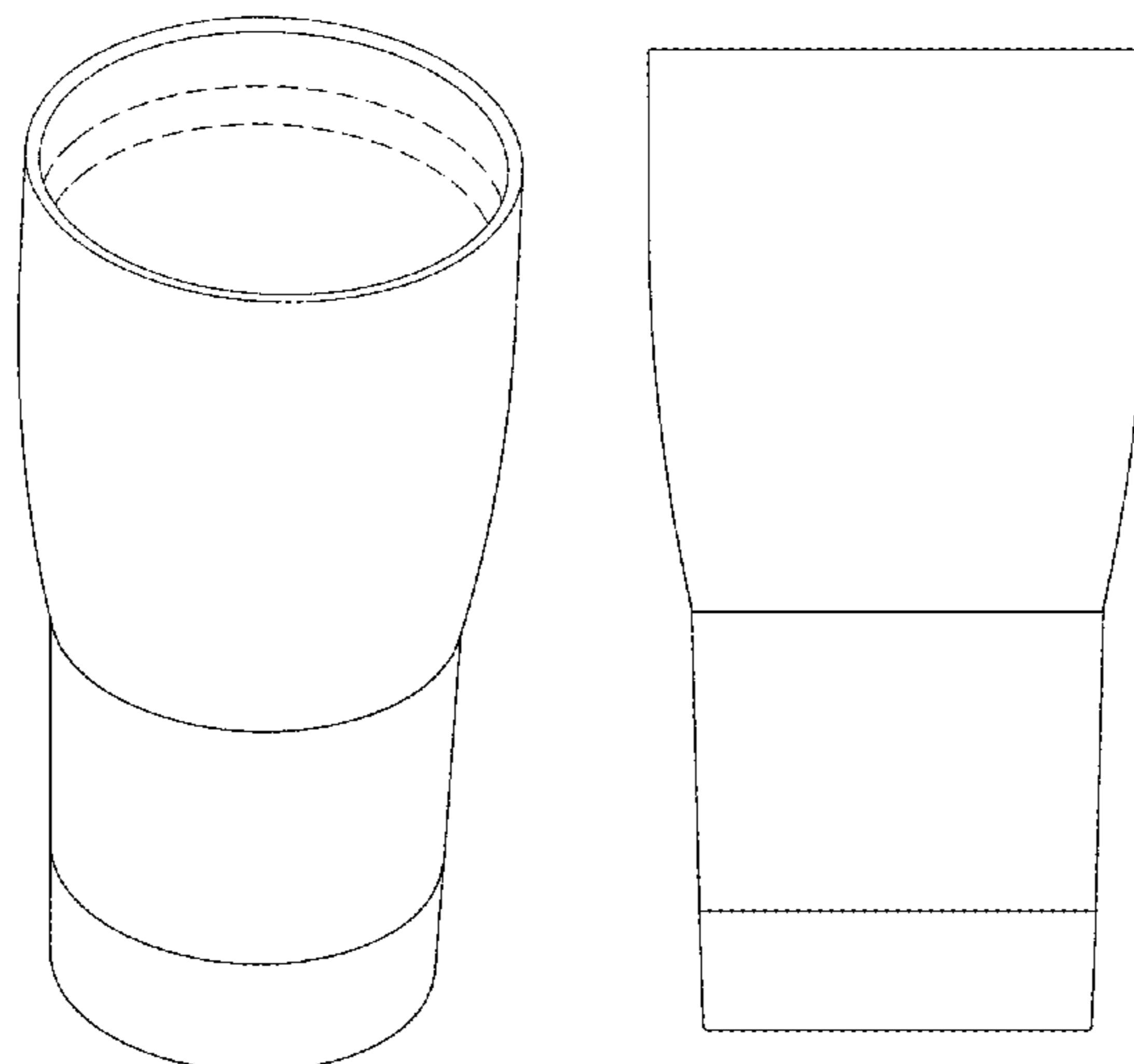

(56)

References Cited

U.S. PATENT DOCUMENTS

D501,758	S	*	2/2005	Lebedev	D7/523
D508,186	S		8/2005	Edelstein		
D512,269	S	*	12/2005	Trombly	D7/510
D525,082	S		7/2006	Copeland		
D528,861	S		9/2006	Herrera		
D528,862	S		9/2006	Li		
D530,154	S		10/2006	Zerillo et al.		
D545,128	S	*	6/2007	Liu	D7/507
D545,624	S		7/2007	Tien		
D547,610	S		7/2007	Edelstein		
D548,012	S		8/2007	Tien		
D560,435	S		1/2008	Meehan		
D565,901	S		4/2008	Edelstein		
D569,183	S	*	5/2008	Blake	D7/509
D569,188	S	*	5/2008	Tornqvist	D7/500
D570,213	S		6/2008	Newman		
D573,840	S	*	7/2008	Kramer	D7/523
D600,073	S		9/2009	Carreno		
D608,147	S	*	1/2010	Sykes	D7/507
RE42,172	E	*	3/2011	Trombly	D7/523
D648,599	S		11/2011	Watanabe et al.		
D686,454	S		7/2013	Roth		
D696,586	S		12/2013	Huang		
D698,200	S		1/2014	Lauwagie		
D719,408	S	*	12/2014	Weber	D7/523
D729,581	S	*	5/2015	Boroski	D7/510
D745,324	S		12/2015	Malaspino		
D766,029	S		9/2016	Lin		
D791,543	S	*	7/2017	Mulhauser	D7/510
D811,817	S	*	3/2018	Harrington, III	D7/510
D814,240	S	*	4/2018	Kabalin	D7/510
2007/0114236	A1		5/2007	Shifter et al.		
2013/0213978	A1		8/2013	Libourel		
2014/0124470	A1*		5/2014	Alberts	A47G 19/2288 215/12.1
2014/0192838	A1*		7/2014	Lawrence	G01K 11/12 374/141

OTHER PUBLICATIONS

22 oz. Translucent Water Bottles, printed from www.promosmall.com on Sep. 24, 2015.
 32 oz. Coca-Cola(R) Cup with Disposable Lid, printed from www.anything4restaurants.com/product/32-oz-coca-cola-cup-with-disposable-lid-235683.html on Sep. 24, 2015.

32 oz. Water Bottle Has Bubble Texture at Base, easy to grip and fits in cup holder, printed from www.promosmall.com/wholesale/ on Sep. 24, 2015.
 Dart 32AJ20E 32-Ounce Flush Fill Capacity 7.1 Inch Height Impulse Stock Printed Pedestal Faom Cup 25-Pack, printed from www.amazon.com/Dart-32AJ20E-32-Ounce-Capacity-Pedestal/dp/B004NG8AMW on Sep. 24, 2015.
 Solo PRG32W-JD477 Reveal Polypropylene Plastic Cold Cup, 32 oz Capacity, Drink/Icy/Chill, printed from www.amazon.com/Solo-PRG32W-JD477-Polypropylene-Plastic-Capacity/dp/B00A0Q827M on Sep. 24, 2015.
 Iconiq(R) Tumblers printed from <https://iconiqbottle.com/collections/stainless-steel-tumblers> on Apr. 13, 2015.
 Boss 20 oz. Stainless Steel Travel Tumbler, printed from www.imprintitems.com/custom/101273162 on Jan. 16, 2016.
 CafeCup Holder Friendly 16 oz. mug with double wall insulation, printed from www.promosmall.com/wholesale/ on Sep. 24, 2015.
 Car Stainless Steel Insulated 16 oz. travel mug, fits most car cup holders, printed from www.promosmall.com/wholesale on Sep. 24, 2015.
 32 oz. Smooth Plastic Cups, printed from www.minithrowballs.com/smooth-plastic-cups-p-253.html on Sep. 24, 2015.
 Dart Solo clear plastic cup, printed from www.gotowebstore.com/30132AC on Sep. 24, 2015.
 Drink Cups, Airlite Plastics—Since 1946, printed from www.airliteplastics.com/products/drink-cups/ on Sep. 24, 2015.
 Gran Touring—Easy grip handle mug, fits most cup holders printed from www.promosmall.com/wholesale/ on Sep. 14, 2015.
 Insulated Mug 32 oz Whirley Cup Stripes Double Wall Travel Truck Stop Refills printed from www.ebay.com/itm/Insulated-Mug-32-oz-Whirley-Cup-STRIPES-Double-Wall-Travel-Truck-Stop-Refills-/160996881401 on Sep. 24, 2015.
 Klean Kanteen: Stainless Steel Vacuum Insulated Tumbler and Cup printed from www.kleankanteen.com/products/Insulated-steel-pint-cup-16-oz?varieant=860278955 on Jan. 16, 2016.
 Magnum Steel 20 oz. Tumbler, printed from www.amazon.com/dp/B019UPELFA?psc=1 on Jan. 16, 2016.
 Oakland Athletics Mugs, printed from www.kohls.com/shop/oakland-athletics-mug.jsp on Apr. 13, 2016.
 Orca 27 oz. Chaser Hot or Cold Tumbler, printed from www.walmart.com on Mar. 14, 2016.
 Stainless Steel Insulated Double Wall Travel Coffee Mug Cup with Car Charger, printed from www.ebay.com/itm/Stainless-Steel-Insulated-Double-Wall-Travel-Coffee-Mug-Cup-w-Car-Adapter-16-oz-/281361760530 on Sep. 24, 2015.
 Commit to Get Fit Tumbler Cups, printed from www.yorhealth.com/products/accessories/Yor-commit-to-get-fit-cups.aspx?localetype=1033 on Sep. 24, 2015.

* cited by examiner

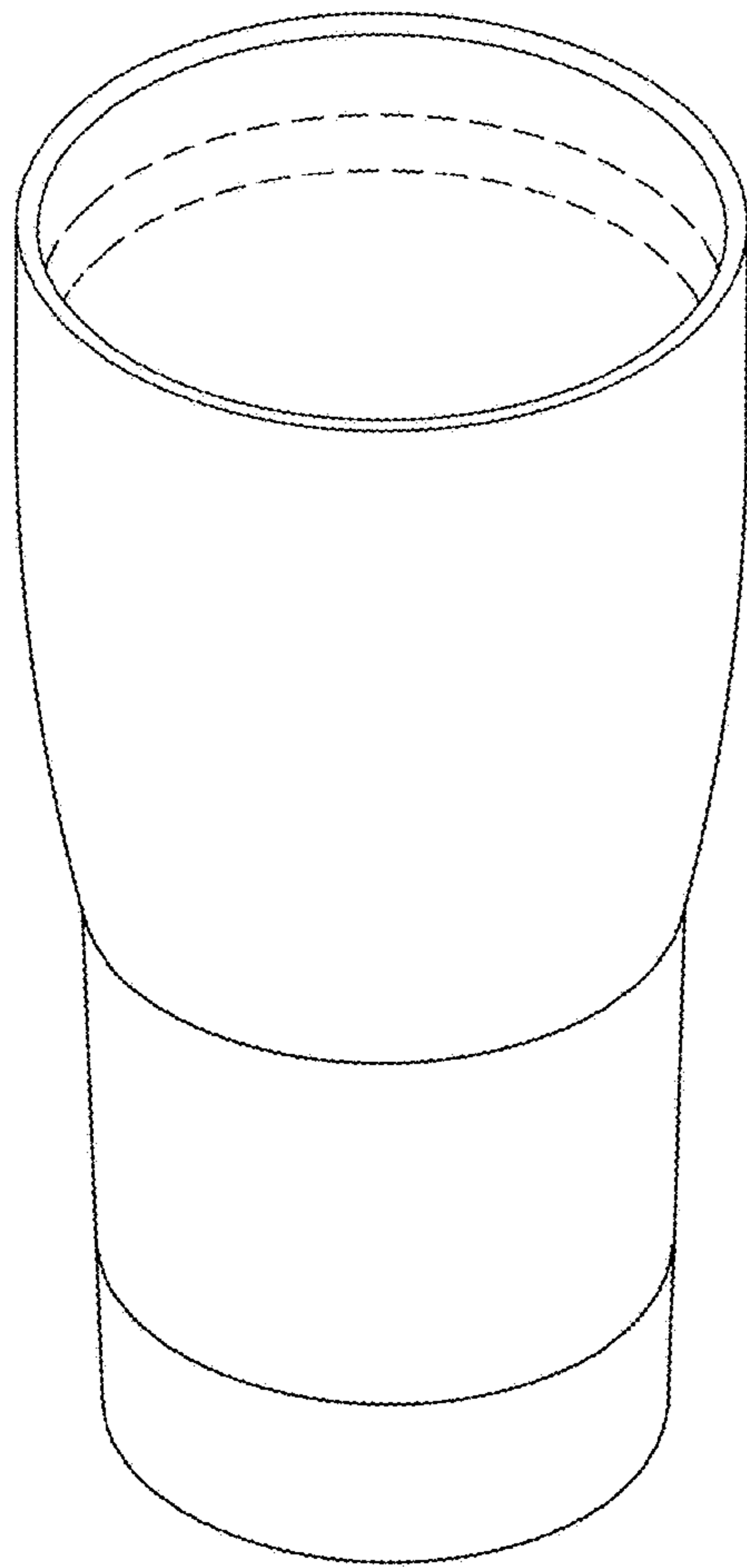

FIG. 1

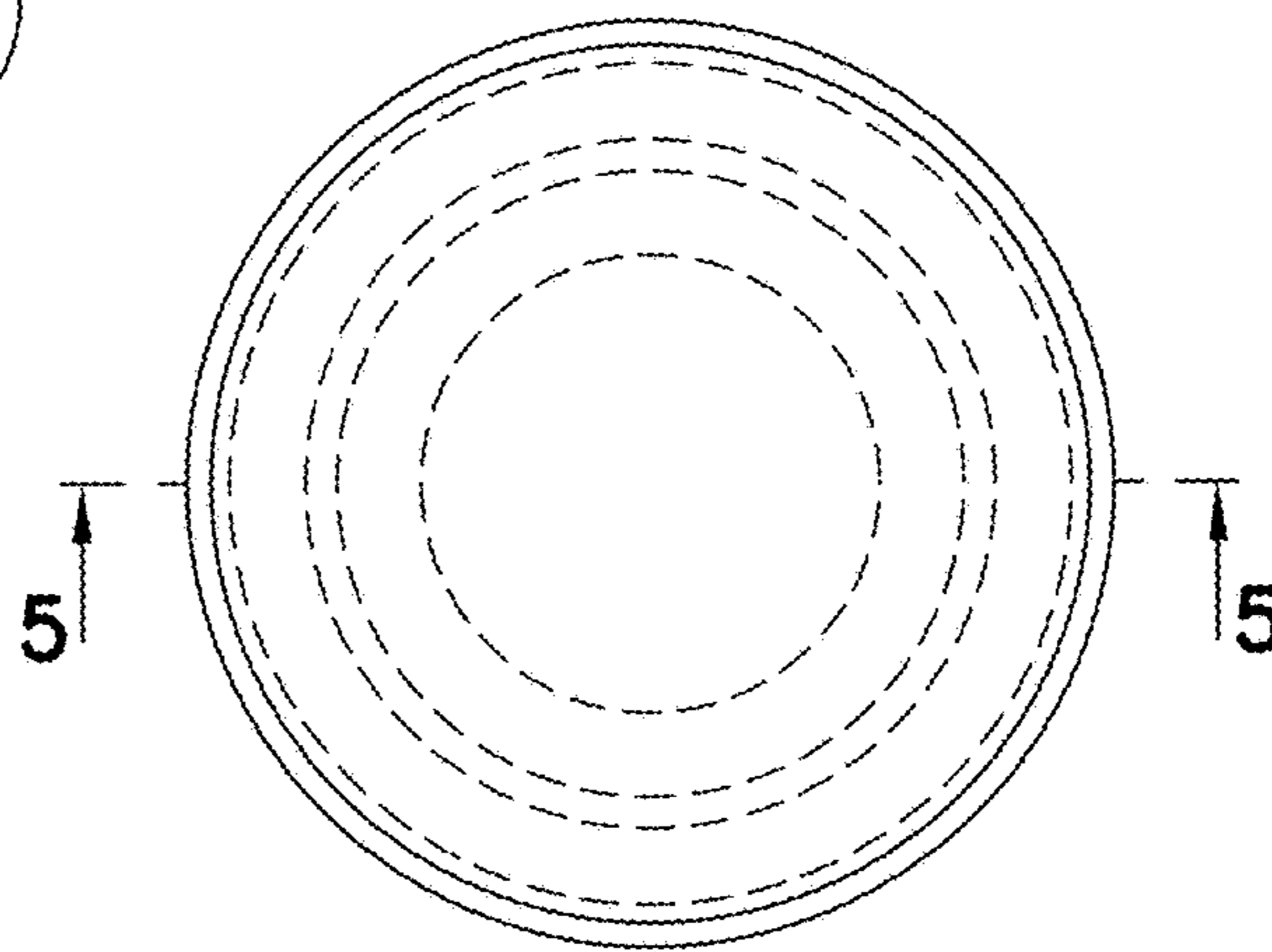

FIG. 2

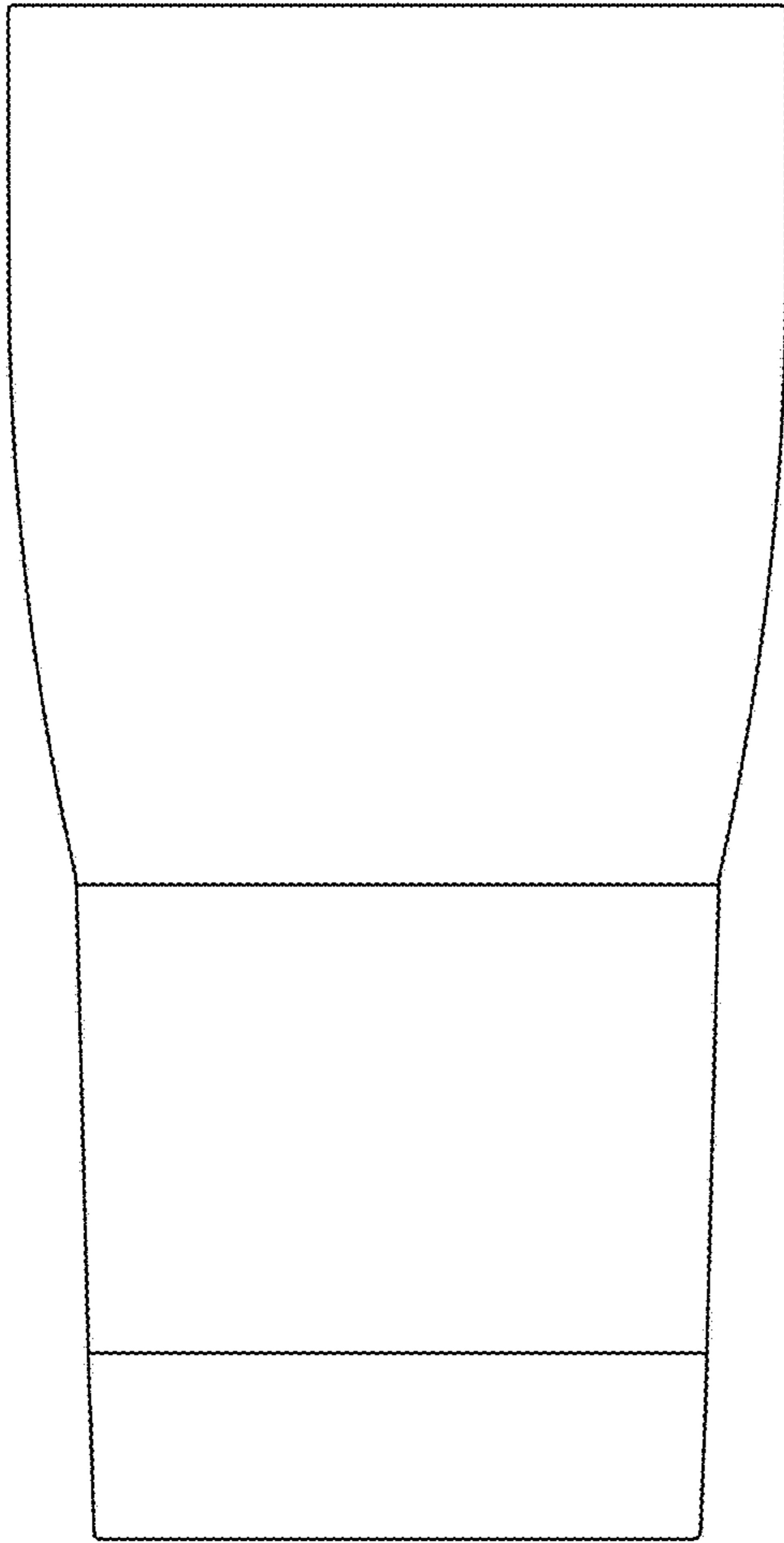

FIG. 3

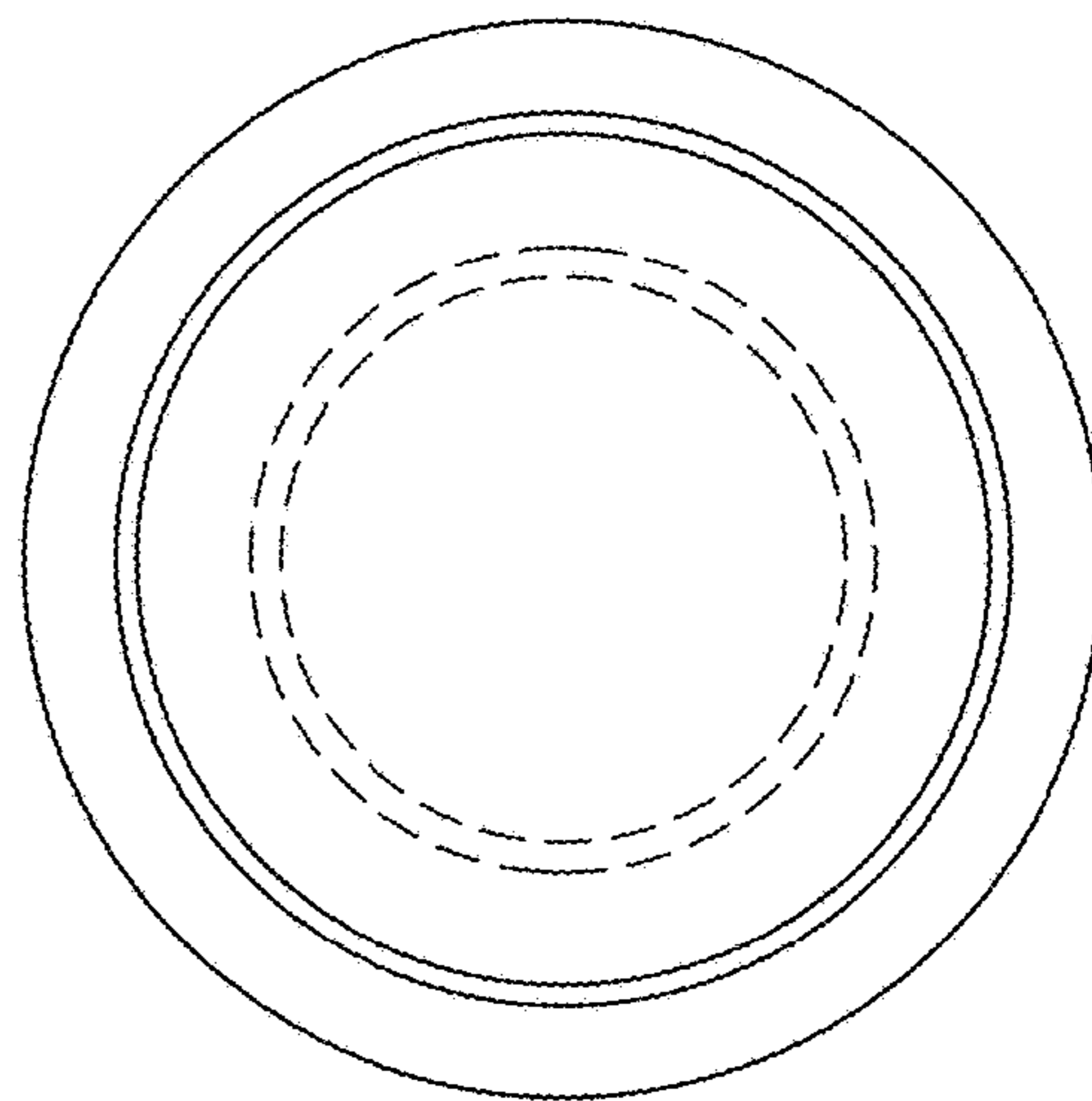

FIG. 4

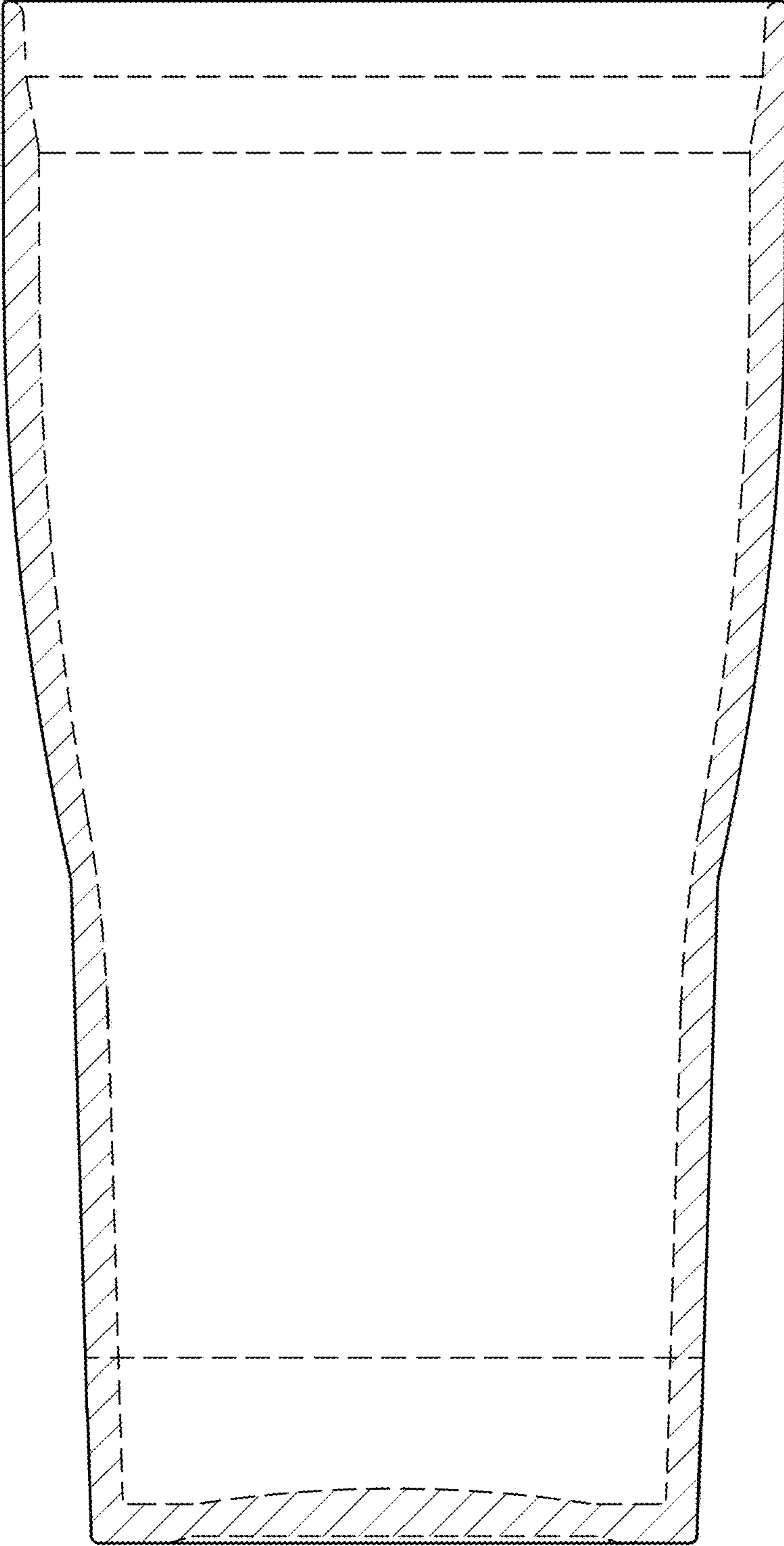

FIG.5

UNITED STATES PATENT AND TRADEMARK OFFICE
CERTIFICATE OF CORRECTION

PATENT NO. : D827,378 S
APPLICATION NO. : 29/605187
DATED : September 4, 2018
INVENTOR(S) : Paul Mulhauser et al.

Page 1 of 1

It is certified that error appears in the above-identified patent and that said Letters Patent is hereby corrected as shown below:

On the Title Page

Item [73], delete:

“The Boeing Company, Chicago, IL”

And insert:

--Silver Buffalo, LLC, New York, NY--.

Signed and Sealed this
Third Day of September, 2019

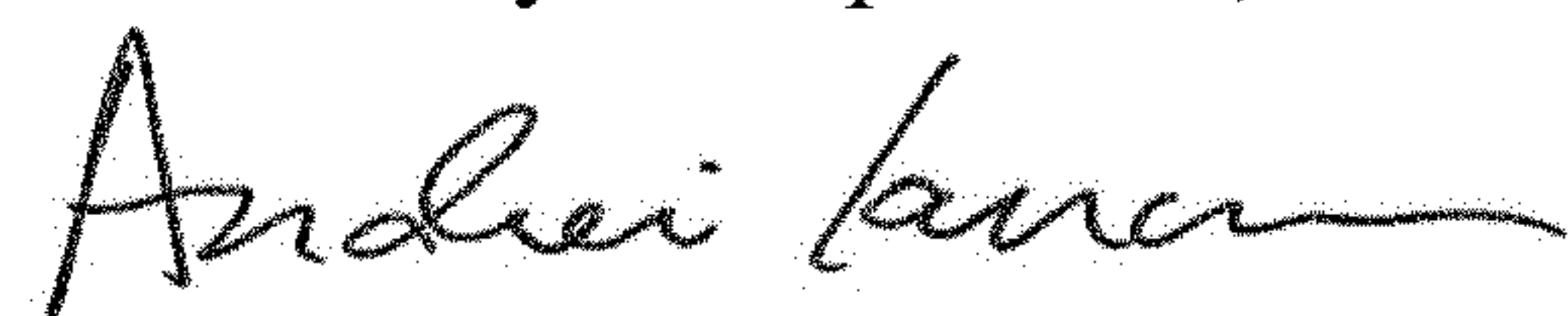

Andrei Iancu
Director of the United States Patent and Trademark Office