

US00D827270S

(12) **United States Design Patent**
Yang et al.

(10) **Patent No.:** **US D827,270 S**
(45) **Date of Patent:** **** Sep. 4, 2018**

- (54) **INSOLE**
- (71) Applicant: **Bayer Healthcare LLC**, Whippany, NJ (US)
- (72) Inventors: **Philip C. Yang**, Memphis, TN (US);
Richard Todd Avent, Memphis, TN (US)
- (73) Assignee: **Bayer HealthCare LLC**, Whippany, NJ (US)
- (**) Term: **15 Years**
- (21) Appl. No.: **29/599,982**
- (22) Filed: **Apr. 7, 2017**
- (51) **LOC (11) Cl.** **02-04**
- (52) **U.S. Cl.**
USPC **D2/961**
- (58) **Field of Classification Search**
USPC D2/946-960, 961, 896, 968; D24/124,
D24/126; 36/43, 44

(Continued)

(56) **References Cited**

U.S. PATENT DOCUMENTS

- 6,301,805 B1 * 10/2001 Howlett A43B 7/142
36/145
- D487,185 S * 3/2004 Grisoni D2/961

(Continued)

OTHER PUBLICATIONS

Orthotics posted by Dr Scholls posted review date Jul. 4, 2017, © Amazon, [online], [site visited May 15, 2018]. Available from Internet, https://www.amazon.com/Dr-Scholls-Orthotics-Plantar-Fasciitis/dp/B01MPYEAI5/ref=cm_cr_ar_p_d_product_top?ie=UTF8 (Year: 2017).*

(Continued)

Primary Examiner — Cynthia Ramirez

Assistant Examiner — Laura H Yu

(74) *Attorney, Agent, or Firm* — Lowenstein Sandler LLP

(57) **CLAIM**

We claim the ornamental design for an insole, as shown and described.

DESCRIPTION

FIG. 1 is a bottom perspective view of an insole showing our new design;

- FIG. 2 is a top perspective view thereof;
- FIG. 3 is a second bottom perspective view thereof;
- FIG. 4 is a bottom view thereof;
- FIG. 5 is a top view thereof;
- FIG. 6 is a side view thereof;
- FIG. 7 is a side view of the opposite side of FIG. 6
- FIG. 8 is a front view thereof;
- FIG. 9 is a rear view thereof;
- FIG. 10 is a bottom perspective view of another embodiment of an insole showing our new design;
- FIG. 11 is a top perspective view thereof;
- FIG. 12 is a second bottom perspective view thereof;
- FIG. 13 is a bottom view thereof;
- FIG. 14 is a top view thereof;
- FIG. 15 is a side view thereof;
- FIG. 16 is a side view of the opposite side of FIG. 15;
- FIG. 17 is a front view thereof;
- FIG. 18 is a rear view thereof;
- FIG. 19 is a bottom perspective view of another embodiment of an insole showing our new design;
- FIG. 20 is a top perspective view thereof;
- FIG. 21 is a second bottom perspective view thereof;
- FIG. 22 is a bottom view thereof;
- FIG. 23 is a top view thereof;
- FIG. 24 is a side view thereof;
- FIG. 25 is a side view of the opposite side of FIG. 24
- FIG. 26 is a front view thereof; and,
- FIG. 27 is a rear view thereof.

The insole shown in FIGS. 1-27 is for a right shoe. The left shoe insole is a mirror image of the right shoe insole and is not shown as it is considered duplicative.

Portions of the insole shown in FIGS. 10-27 are illustrated with gray shading to show contrast.

The dash-dash broken lines shown in the drawings illustrate portions of the insole that form no part of the claimed design.

The dash-dot broken lines define the bounds of the claimed design and form no part thereof.

1 Claim, 27 Drawing Sheets

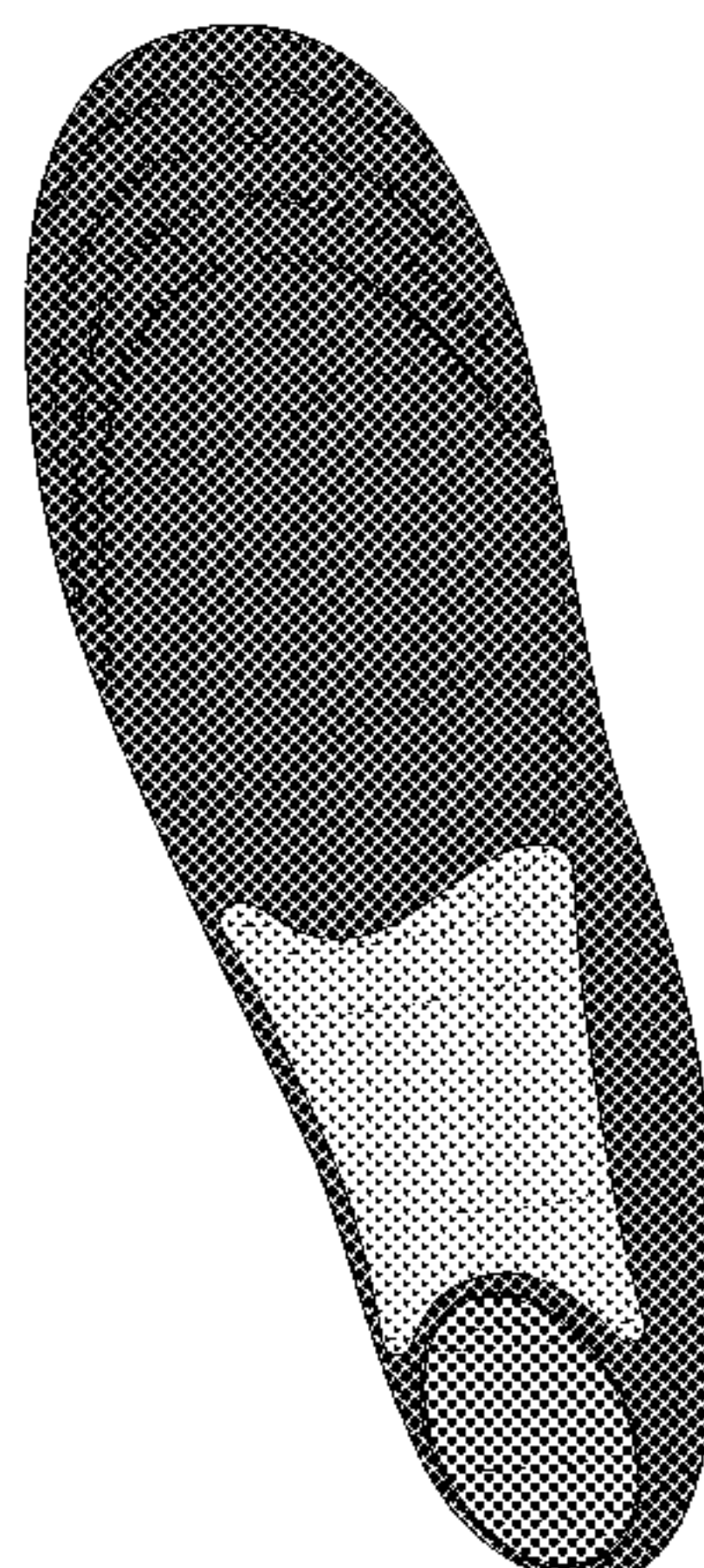
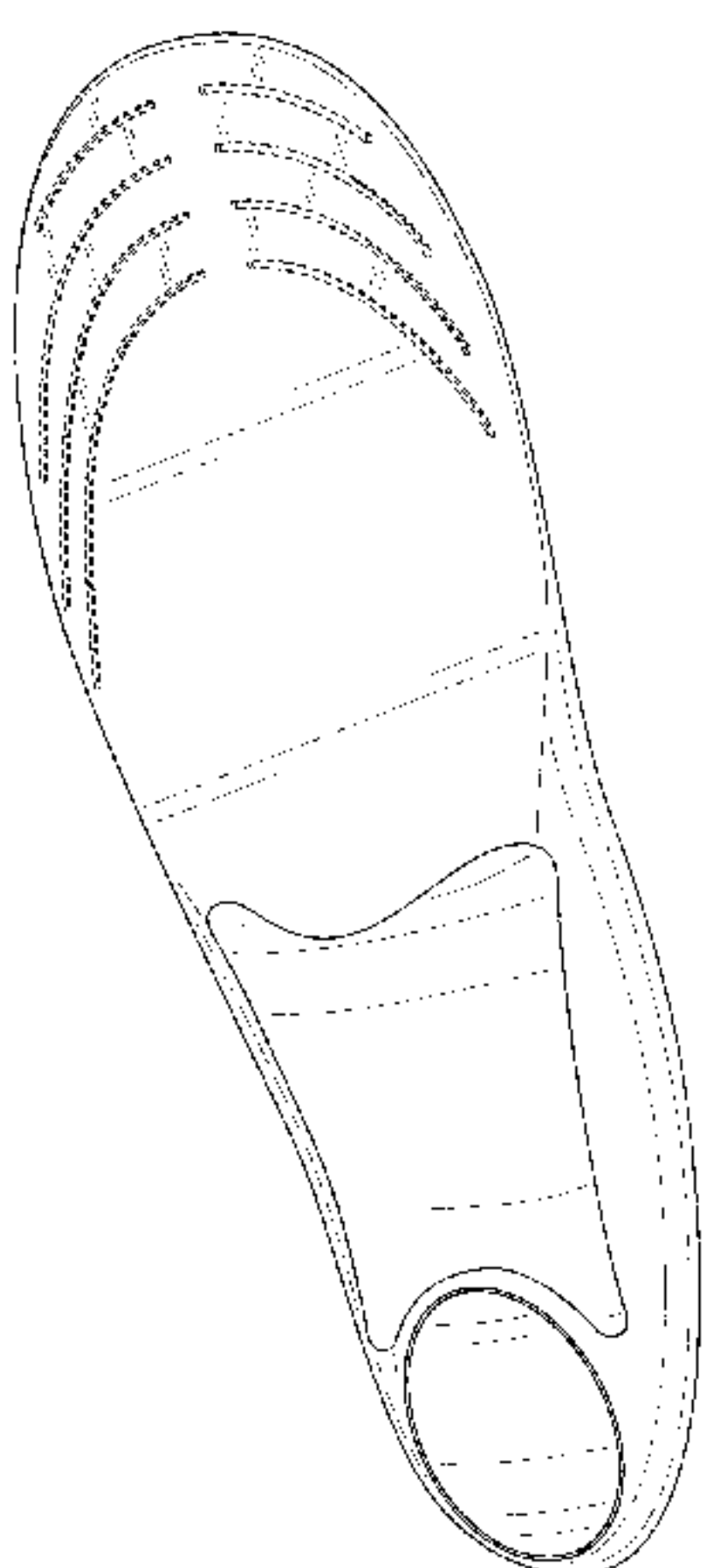

(58) **Field of Classification Search**

CPC A43B 19/00; A43B 17/14; A43B 17/02;
A43B 17/03; A43B 13/14; A43B 17/00;
A43B 17/18; A43B 7/149; A43B 7/14;
A43B 19/005; A43B 17/026; A43B
9/125; A43B 17/006; A43B 13/00; A43B
13/42

See application file for complete search history.

(56)

References Cited

U.S. PATENT DOCUMENTS

D664,754 S * 8/2012 Klein D2/961
D753,908 S * 4/2016 Vasyli D2/961
D797,430 S * 9/2017 Granger D2/961
D811,709 S * 3/2018 Buck D2/961

2004/0181971 A1* 9/2004 Turkbash A43B 7/141
36/44
2010/0218399 A1* 9/2010 Jeong A43B 7/141
36/44
2012/0204444 A1* 8/2012 Liu A43B 1/0045
36/44

OTHER PUBLICATIONS

Athletic Running Insoles posted by Dr Scholls posted review date Jul. 7, 2017, © Amazon, [online], [site visited May 15, 2018]. Available from Internet, https://www.amazon.com/Dr-Scholls-Athletic-Running-Insoles/dp/B01M9GSQST/ref=cm_cr_arp_d_product_top?ie=UTF8 (Year: 2017).*

Sole Plantar Fascia Insole posted by SOF Sole posted review date Mar. 12, 2014, © Amazon, [online], [site visited May 15, 2018]. Available from Internet, https://www.amazon.com/Sof-Sole-Plantar-Fascia-Fasciitis/dp/B00F9AK23Q/ref=cm_cr_arp_d_product_top?ie=UTF8 (Year: 2014).*

* cited by examiner

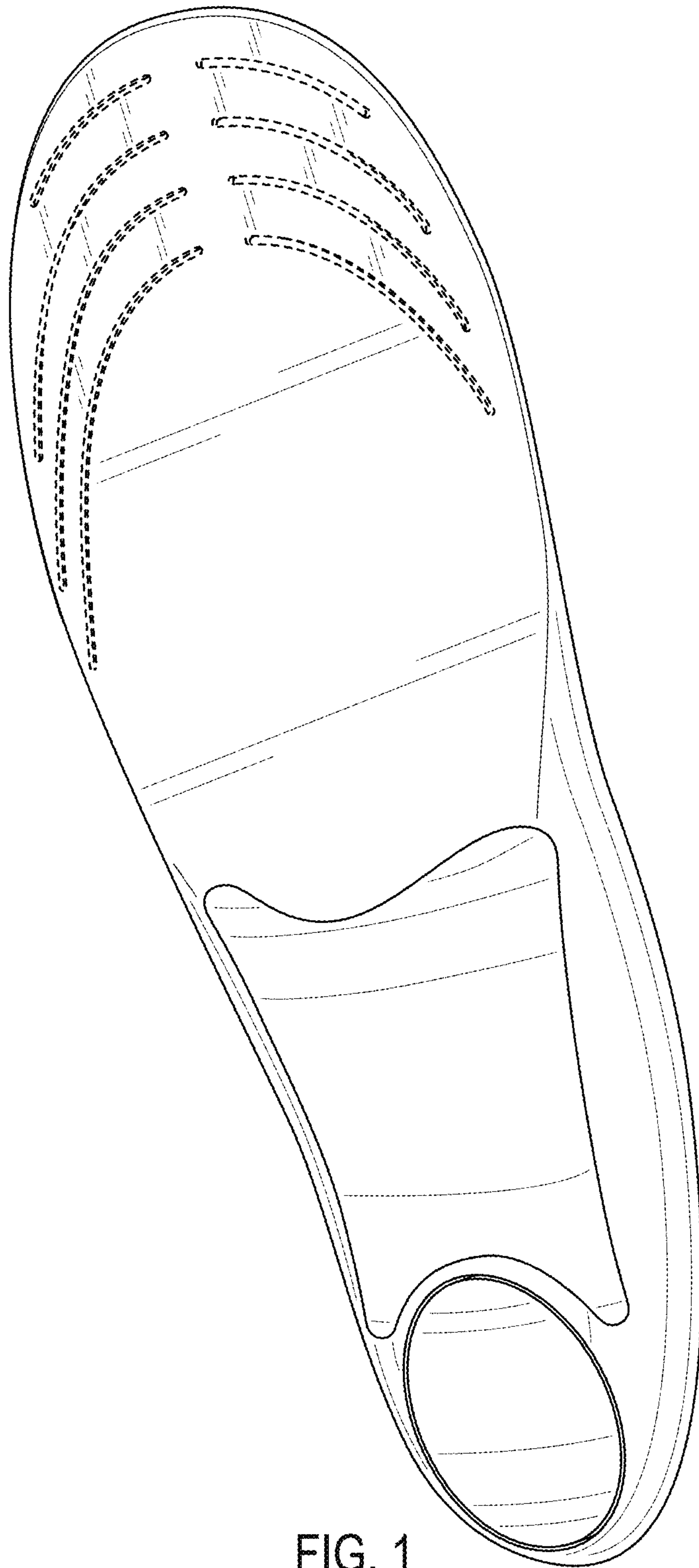

FIG. 1

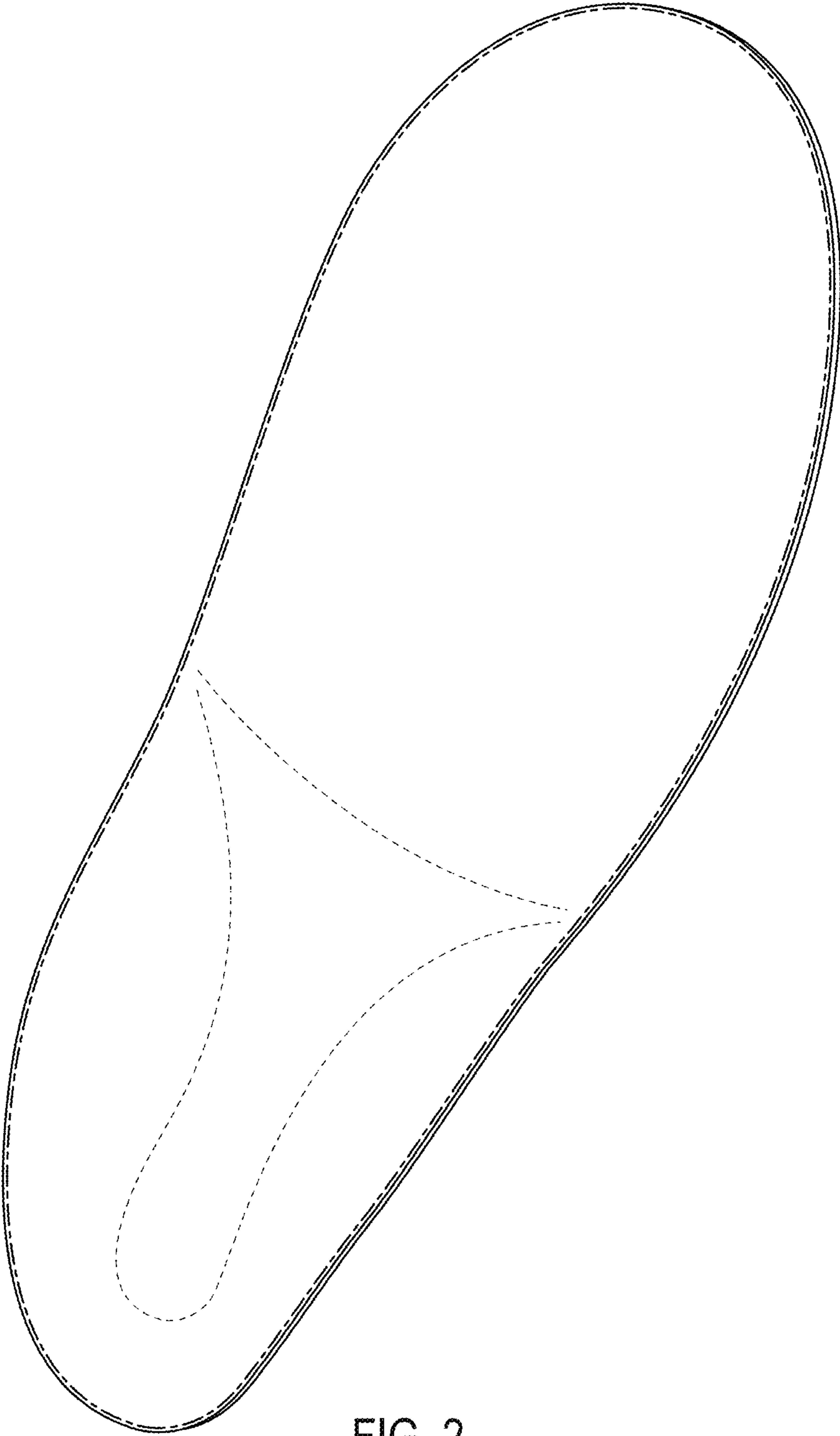

FIG. 2

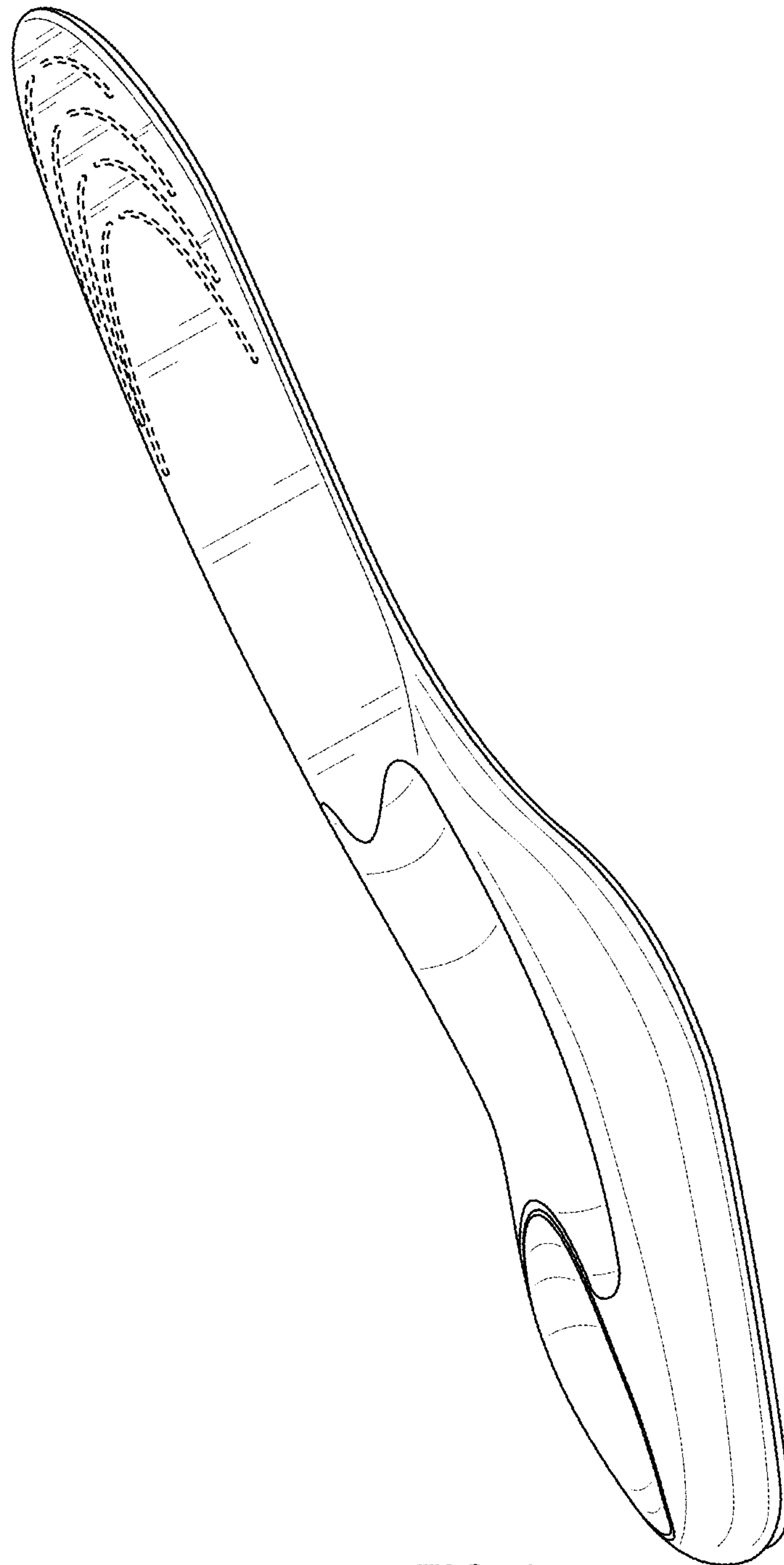

FIG. 3

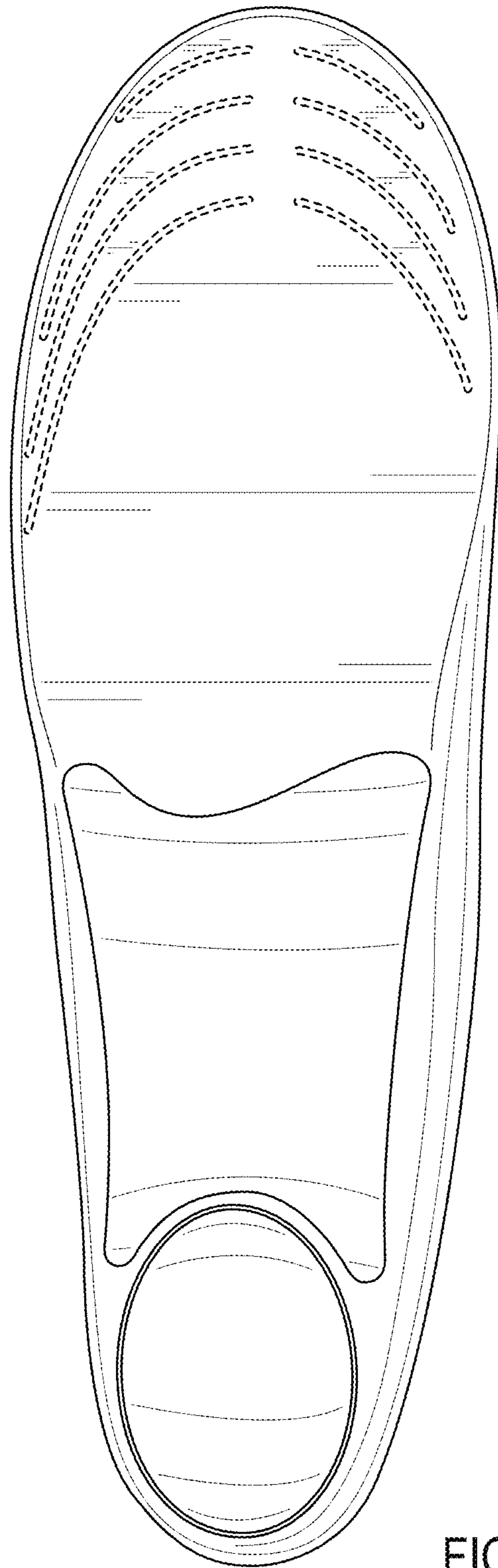

FIG. 4

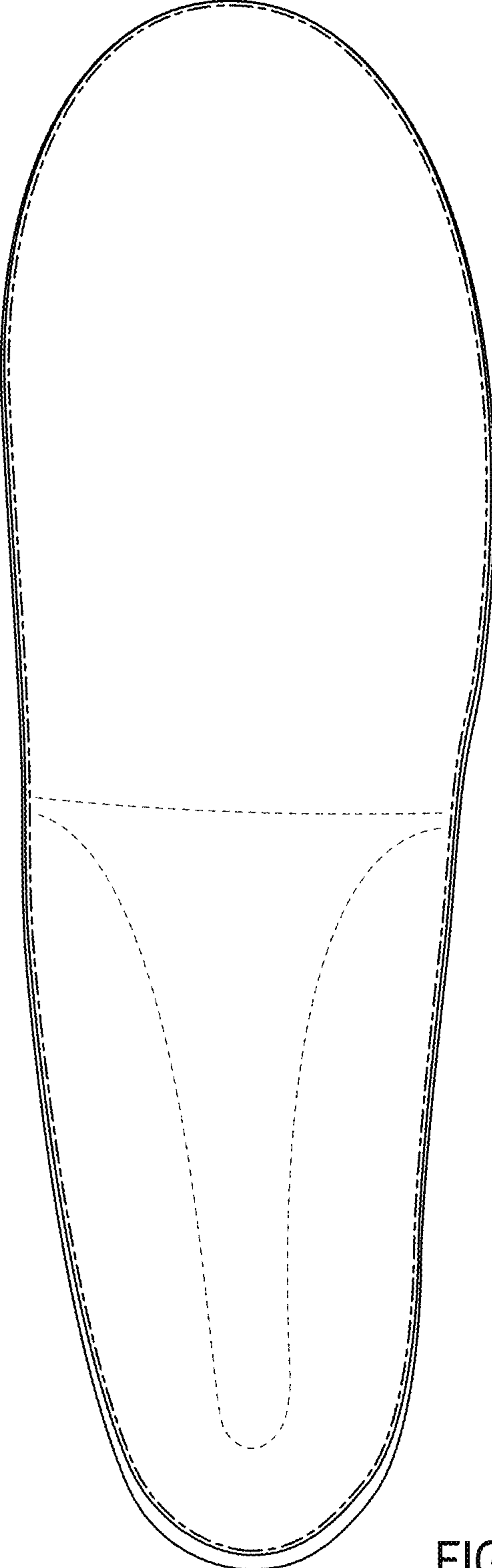

FIG. 5



FIG. 6



FIG. 7

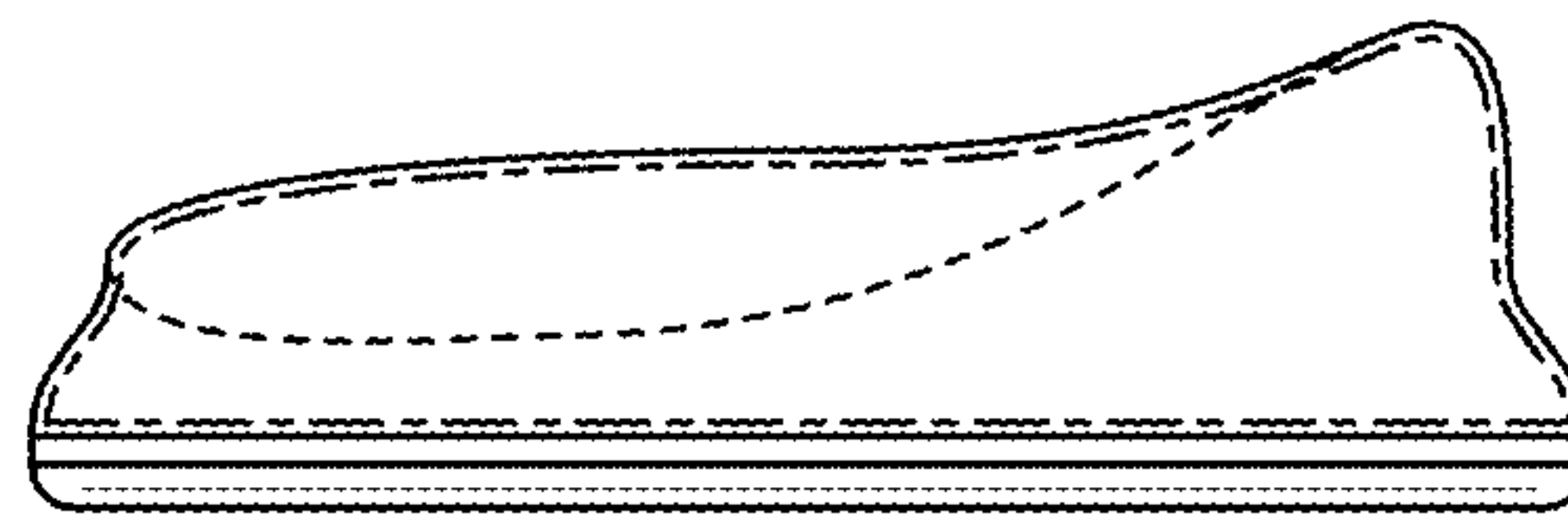

FIG. 8

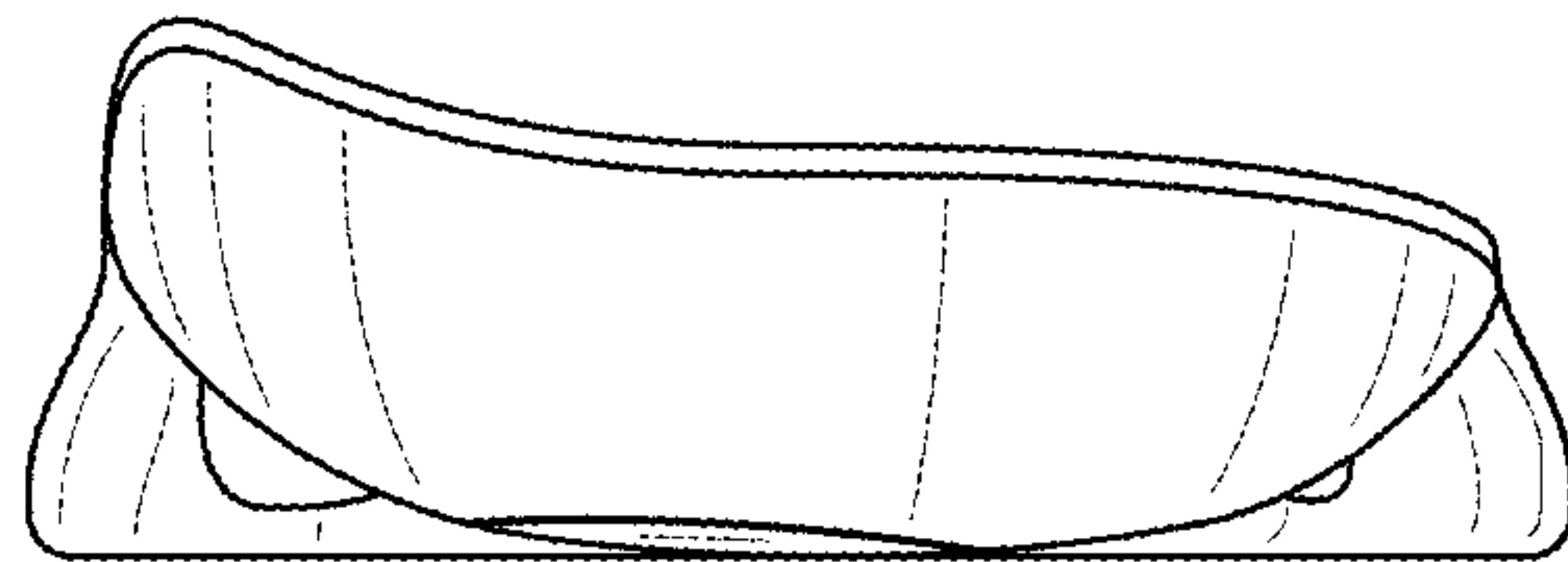

FIG. 9

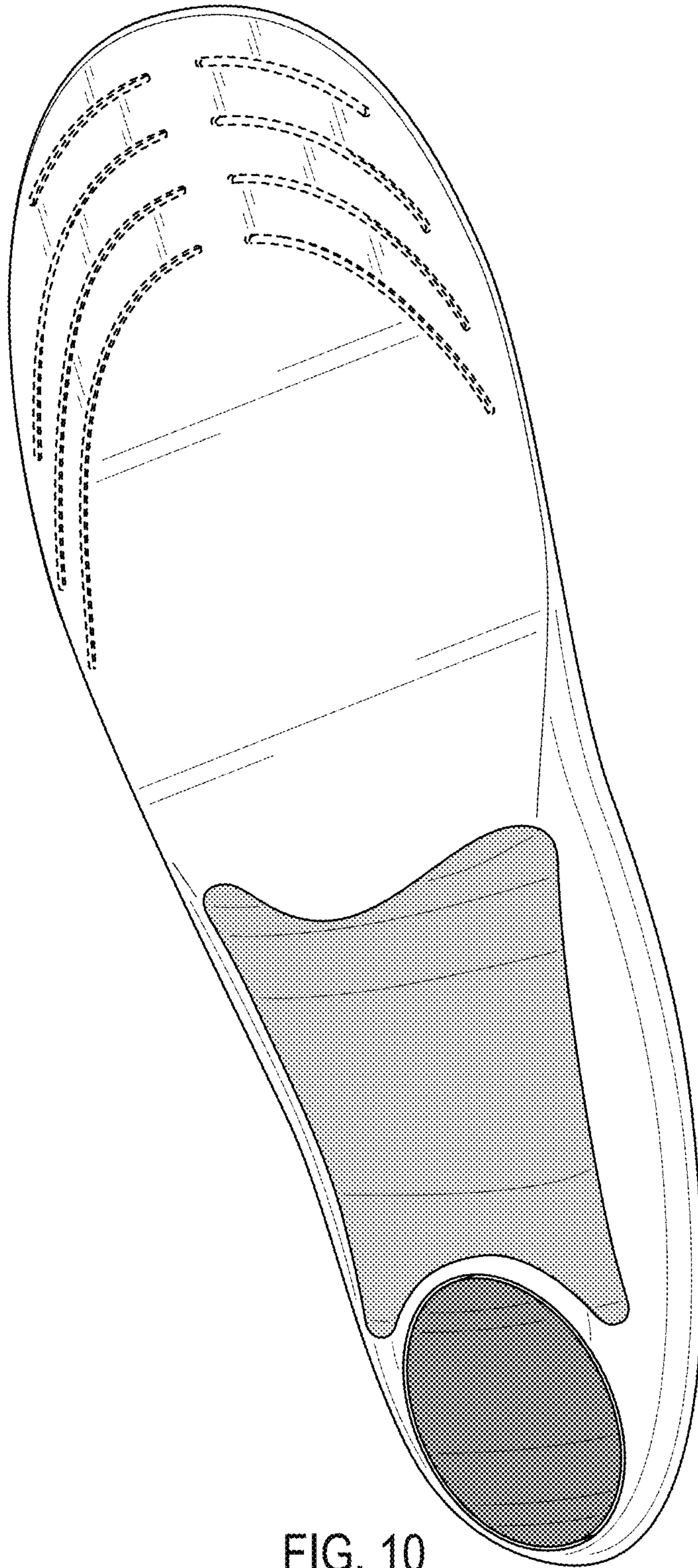

FIG. 10

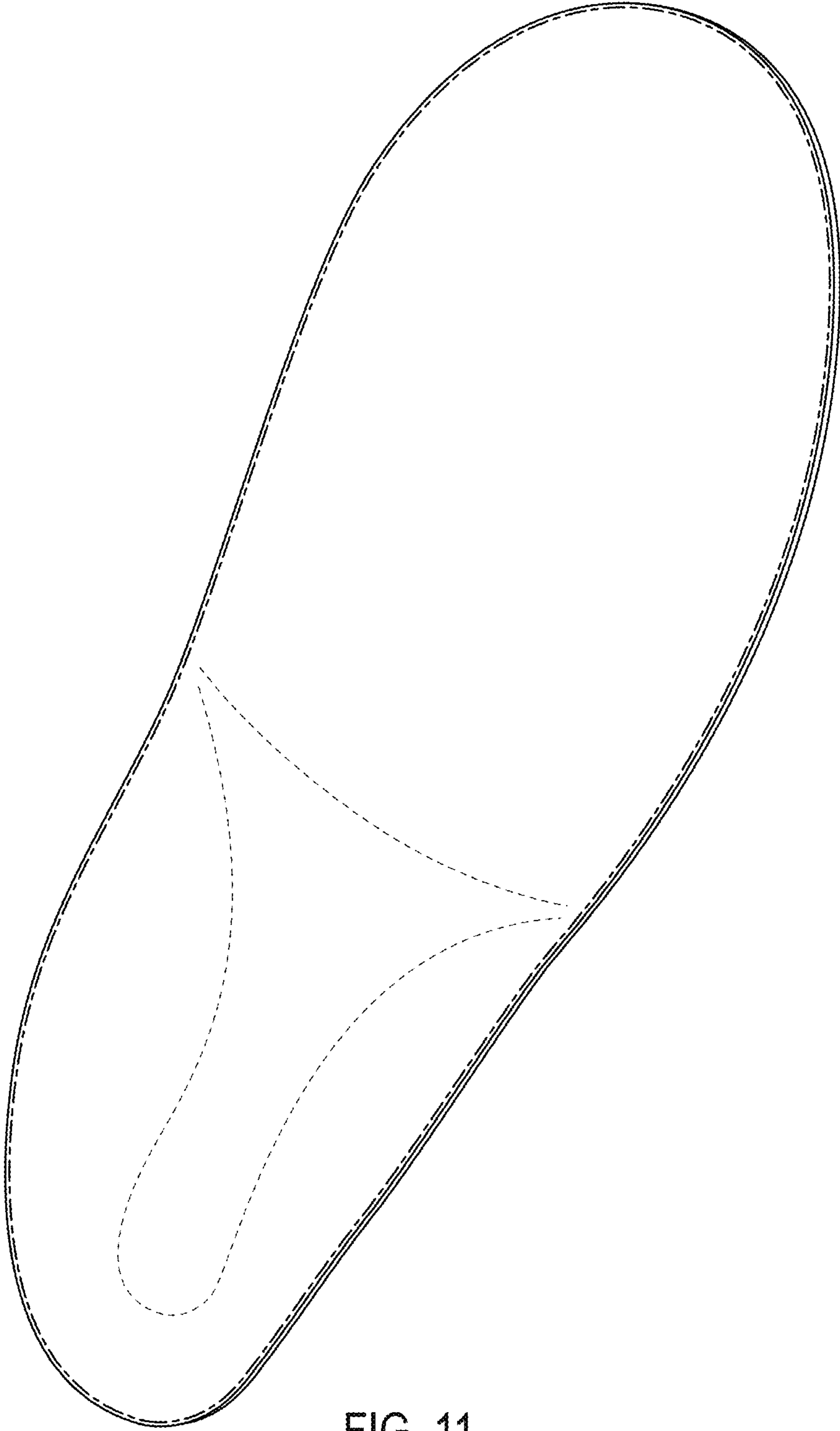

FIG. 11

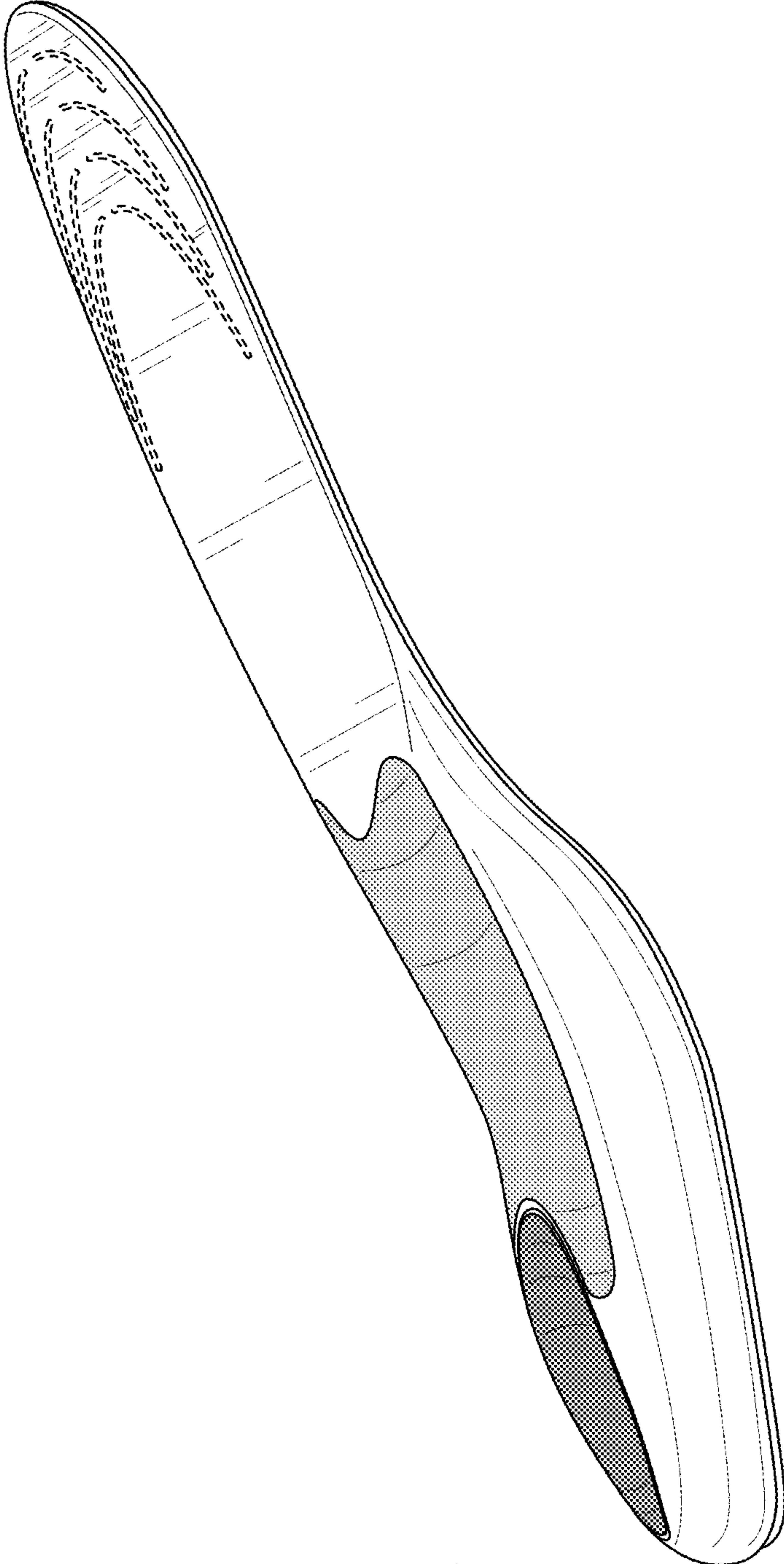

FIG. 12

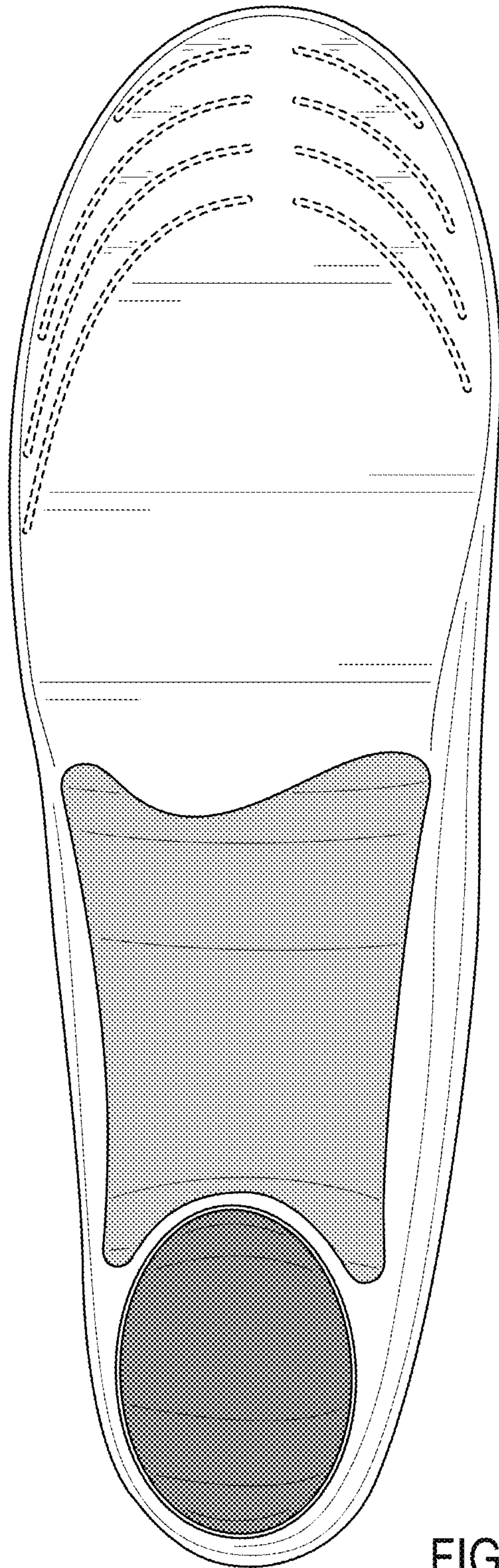

FIG. 13

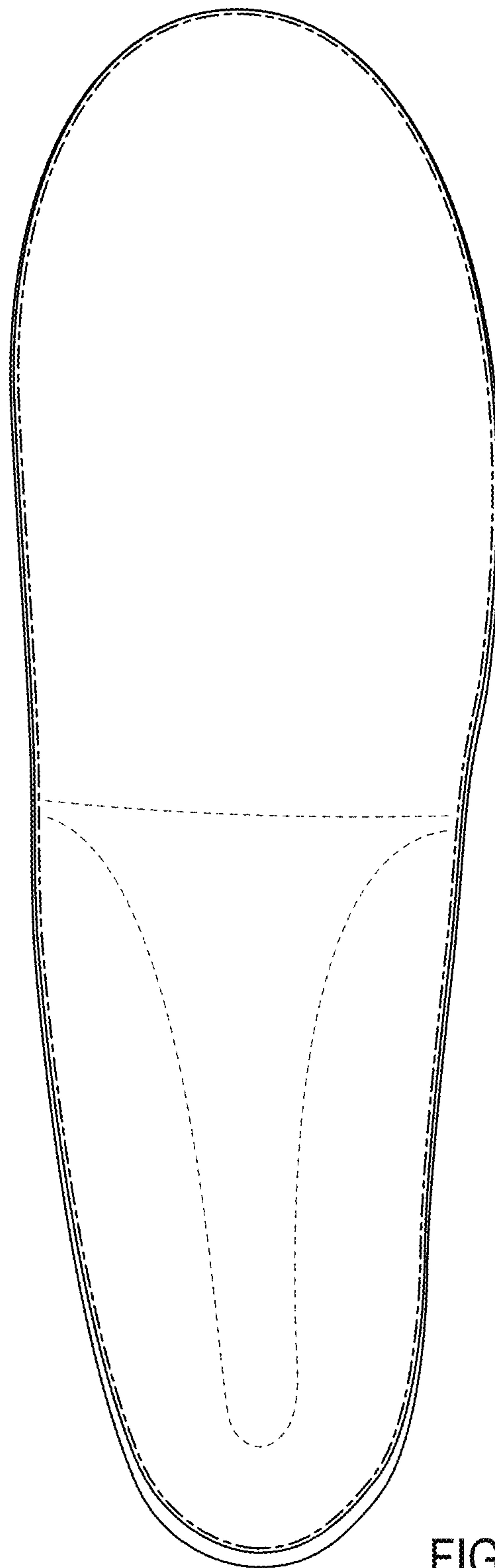

FIG. 14



FIG. 15



FIG. 16

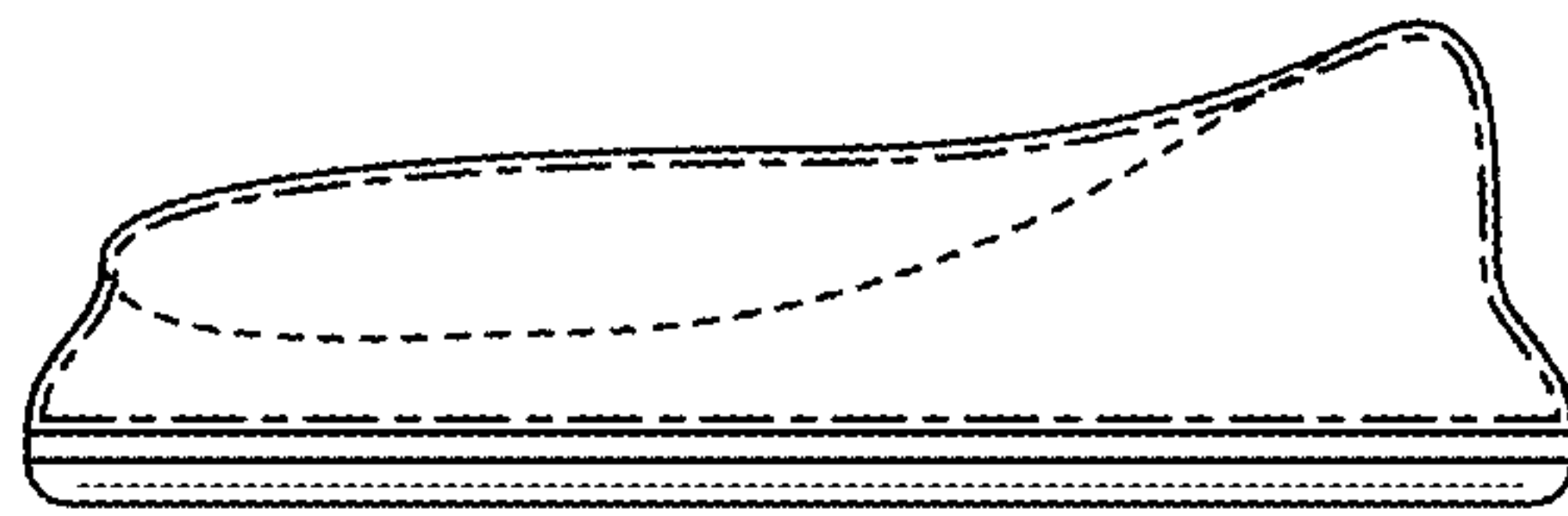

FIG. 17

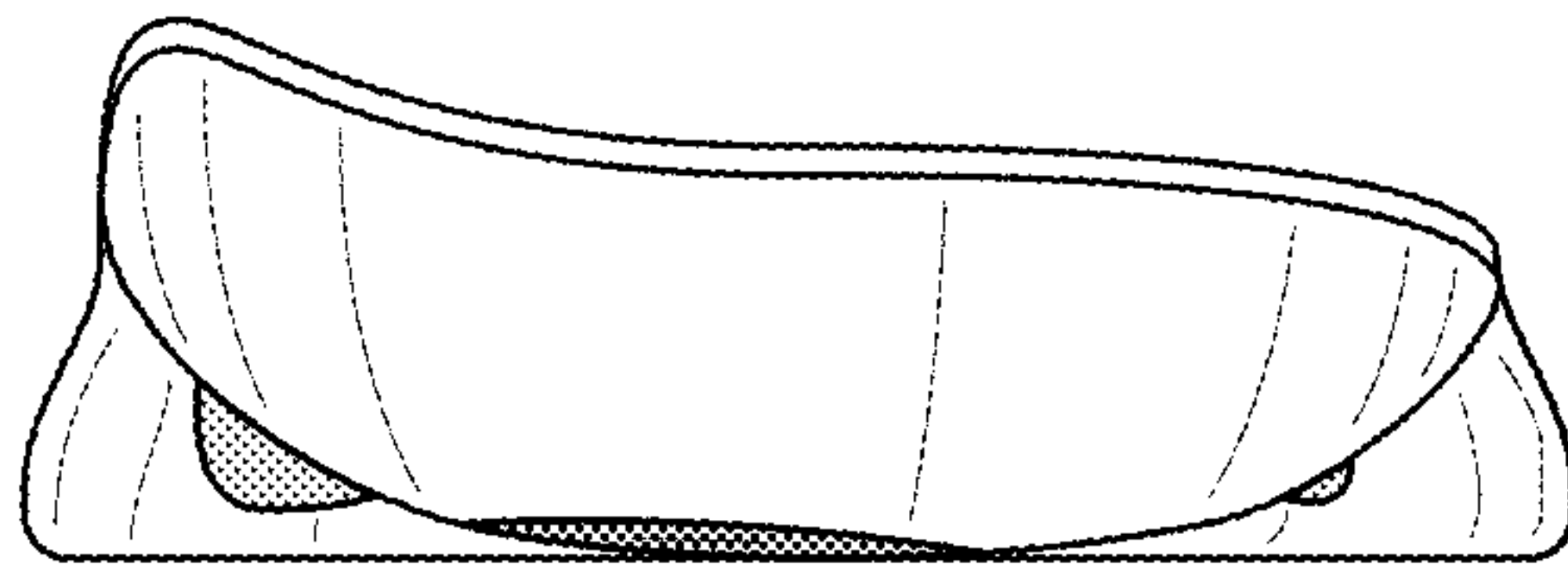

FIG. 18

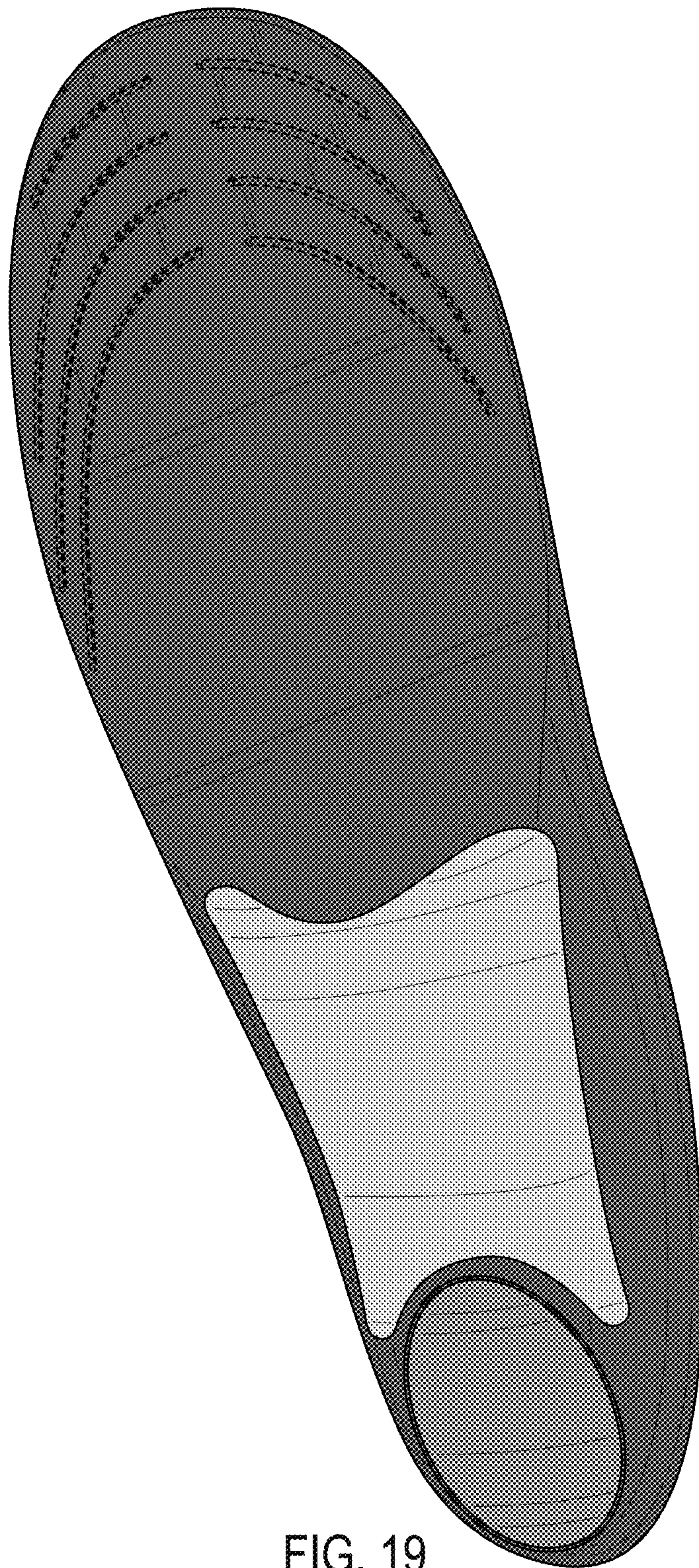

FIG. 19



FIG. 20

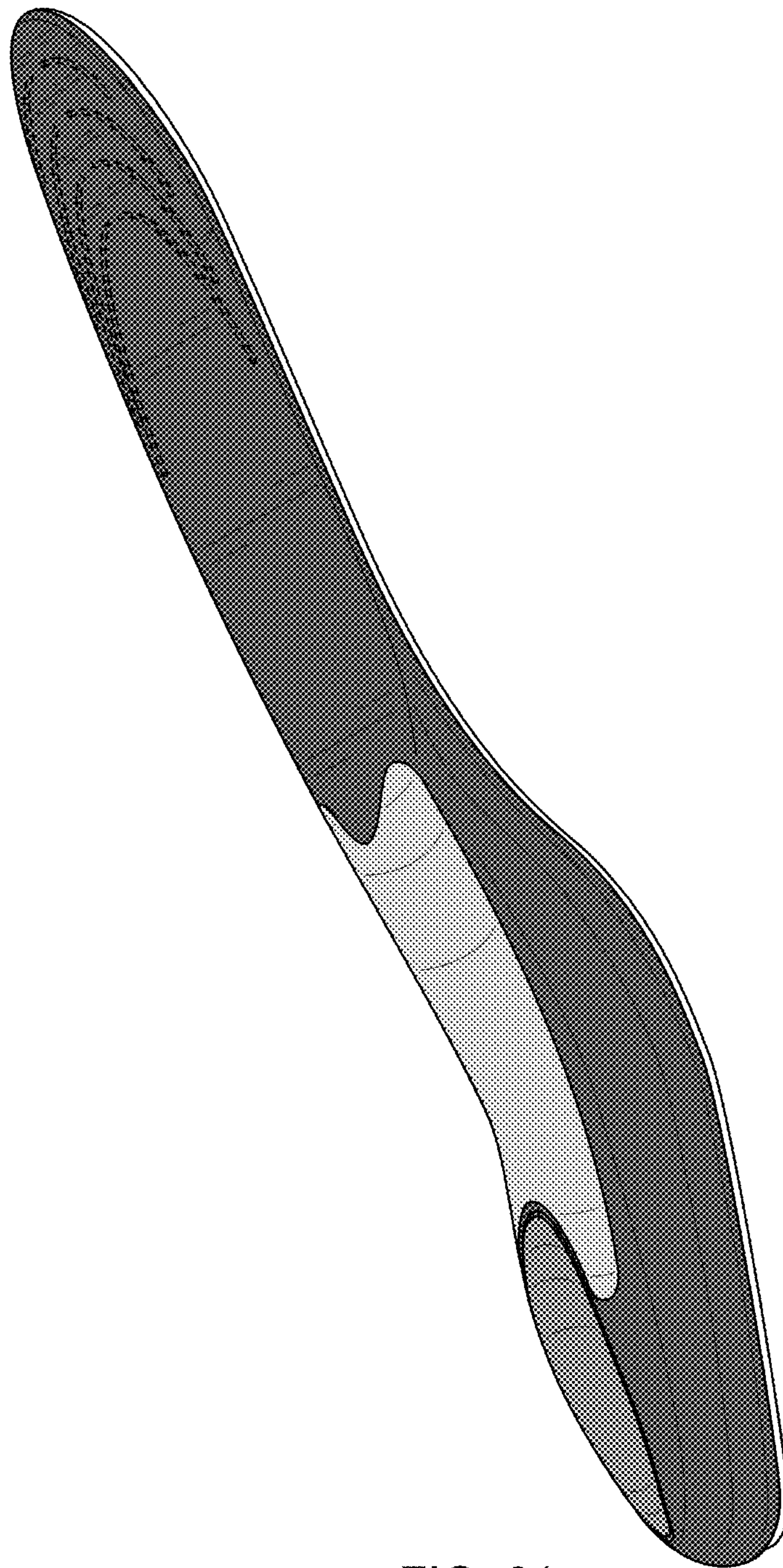

FIG. 21

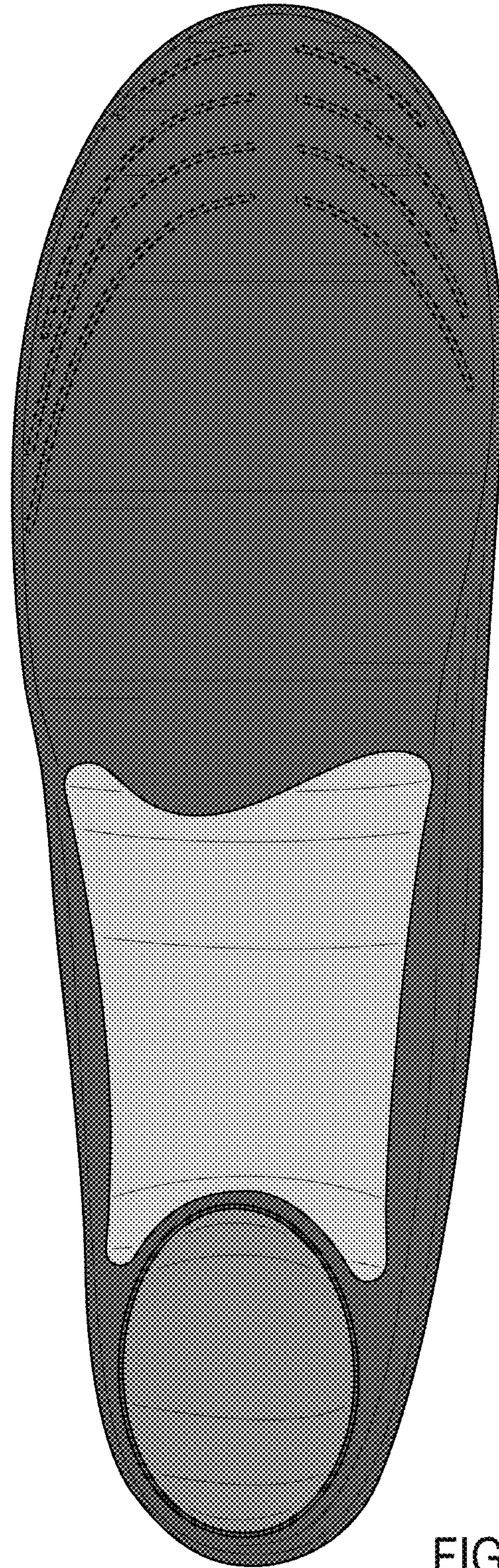

FIG. 22

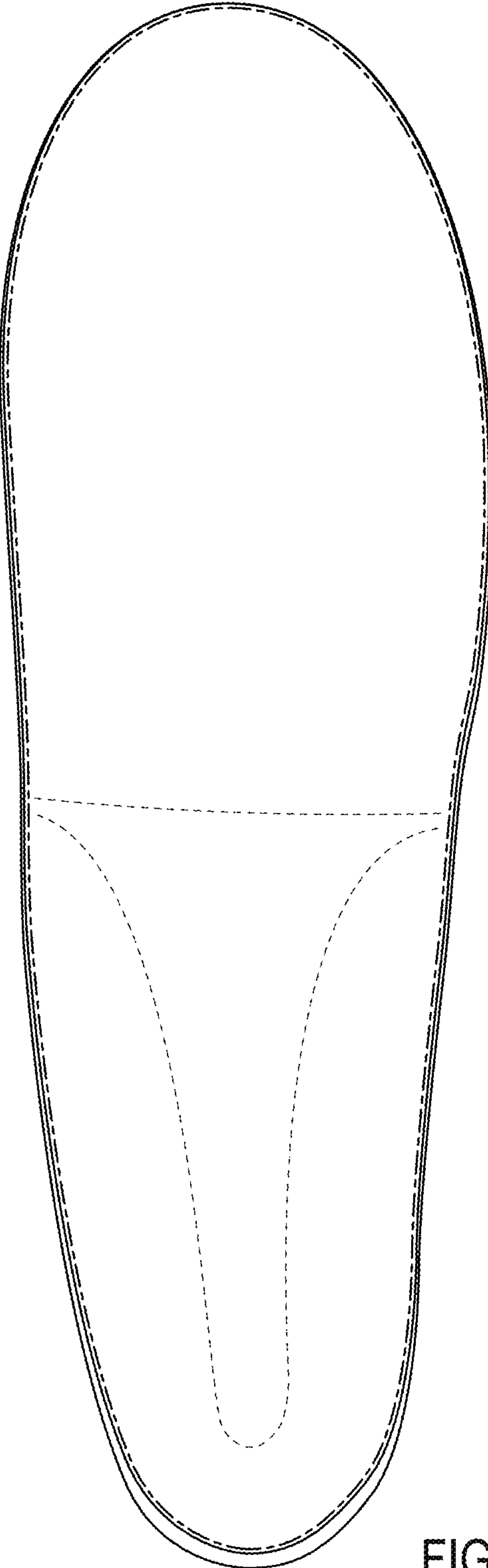

FIG. 23

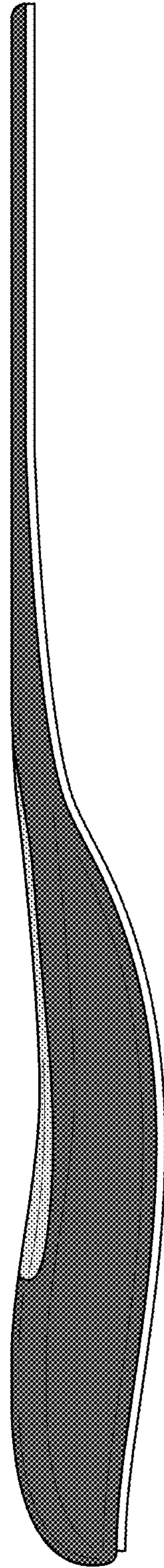

FIG. 24

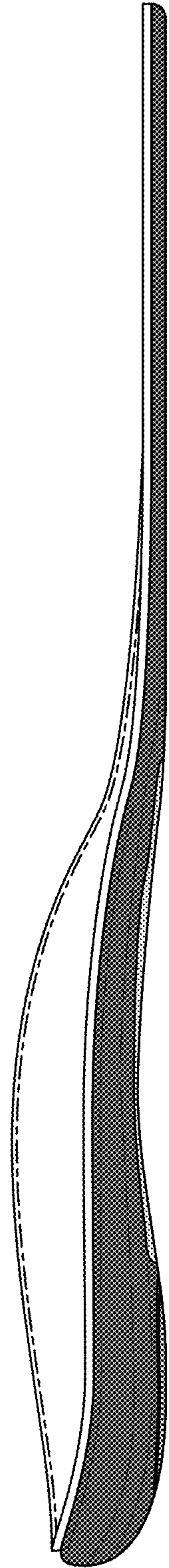

FIG. 25

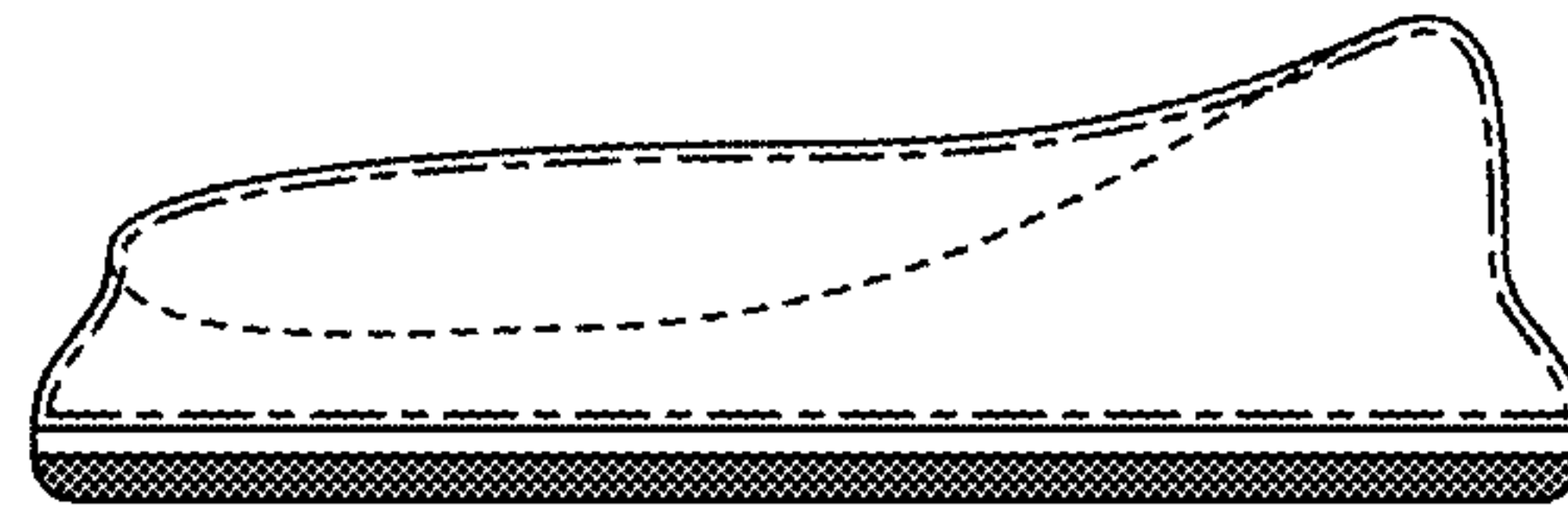

FIG. 26

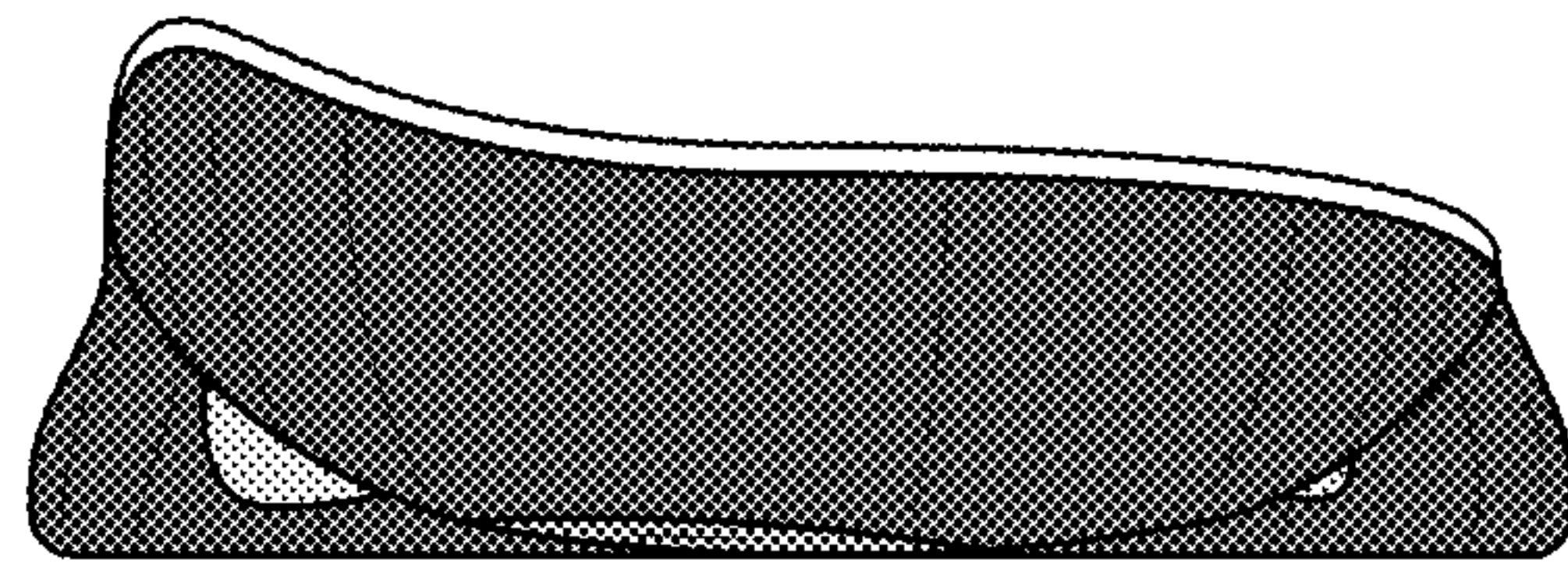

FIG. 27