



US00D827159S

(12) **United States Design Patent** (10) **Patent No.:** **US D827,159 S**  
**Anderson et al.** (45) **Date of Patent:** **\*\* Aug. 28, 2018**

(54) **ROOFING PANEL**  
(71) Applicant: **Building Materials Investment Corporation**, Dallas, TX (US)  
(72) Inventors: **Eric R. Anderson**, Montclair, NJ (US); **Tommy Rodrigues**, Nutley, NJ (US); **Sudhir Railkar**, Wayne, NJ (US)  
(73) Assignee: **Building Materials Investment Corporation**, Dallas, TX (US)

(\*\*) Term: **15 Years**

(21) Appl. No.: **29/594,060**

(22) Filed: **Feb. 15, 2017**

(51) **LOC (11) Cl.** ..... **25-01**

(52) **U.S. Cl.**  
USPC ..... **D25/141**

(58) **Field of Classification Search**  
USPC ..... D25/138-163  
CPC .... E04D 1/00; E04D 1/02; E04D 1/06; E04D 1/12; E04D 1/18; E04D 1/26; E04D 3/00; E04D 3/02; E04D 3/16; E04D 3/24; E04D 3/30; E04D 3/361; E04D 3/362; E04D 3/363; E04D 3/364; E04D 3/368; E04D 2001/005; E04D 2001/3491; E04D 7/005; E04D 1/265; E04D 1/30; E04D 1/34; E04F 2201/0115; E04F 2201/0153; E04F 13/08; E04F 13/0837; E04F 13/0864; E04F 13/0894; E04B 1/70  
See application file for complete search history.

(56) **References Cited**

**U.S. PATENT DOCUMENTS**

1,329,794 A 2/1920 Moomaw  
1,539,632 A 5/1925 Belding  
2,042,890 A 6/1936 Fulenwinder et al.  
3,380,214 A \* 4/1968 Stevens ..... E04D 1/265  
52/478

3,593,479 A \* 7/1971 Hinds ..... B44F 9/02  
52/313  
4,189,889 A 2/1980 Yanoh  
4,499,700 A 2/1985 Gustafsson  
5,295,338 A 3/1994 Guffey et al.  
5,465,543 A 11/1995 Siefert  
5,752,355 A 5/1998 Sahramaa  
5,768,844 A 6/1998 Grace, Sr. et al.  
5,881,501 A 3/1999 Guffey et al.  
D414,568 S 9/1999 Hedges et al.  
6,272,807 B1 8/2001 Waldrop  
D449,121 S 10/2001 Hunter et al.  
D449,897 S \* 10/2001 Croft ..... D25/139

(Continued)

*Primary Examiner* — Vy N Koenig  
*Assistant Examiner* — Kimberly Barnes  
(74) *Attorney, Agent, or Firm* — Womble Bond Dickinson (US) LLP

(57) **CLAIM**

The ornamental design for a roofing panel, as shown and described.

**DESCRIPTION**

FIG. 1 is a perspective view of a roofing panel in accordance with our invention.  
FIG. 2 is a top plan view of the roofing panel of FIG. 1.  
FIG. 3 is a bottom plan view of the roofing panel of FIG. 1.  
FIG. 4 is a front elevation view of the roofing panel of FIG. 1.  
FIG. 5 is a rear elevation view of the roofing panel of FIG. 1.  
FIG. 6 is an enlarged right side elevation view of the roofing panel of FIG. 1.  
FIG. 7 is an enlarged left side elevation view of the roofing panel of FIG. 1; and,  
FIG. 8 is an enlarged perspective view of the right end portion of the roofing panel identified with the numeral "8" in FIG. 1.

**1 Claim, 4 Drawing Sheets**

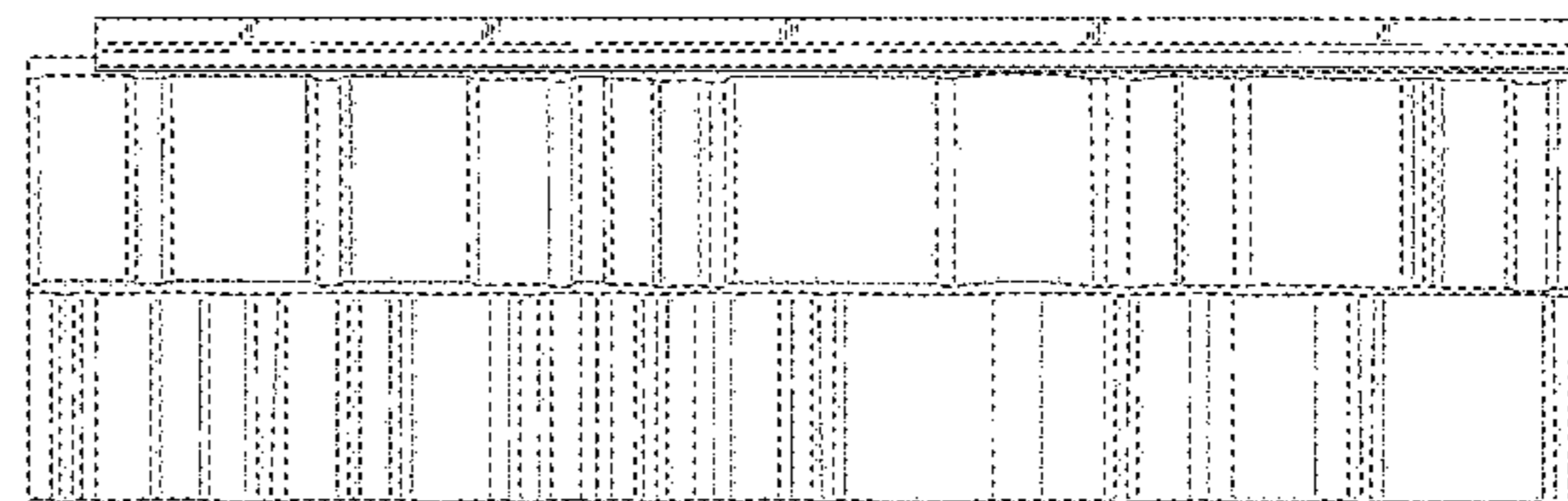
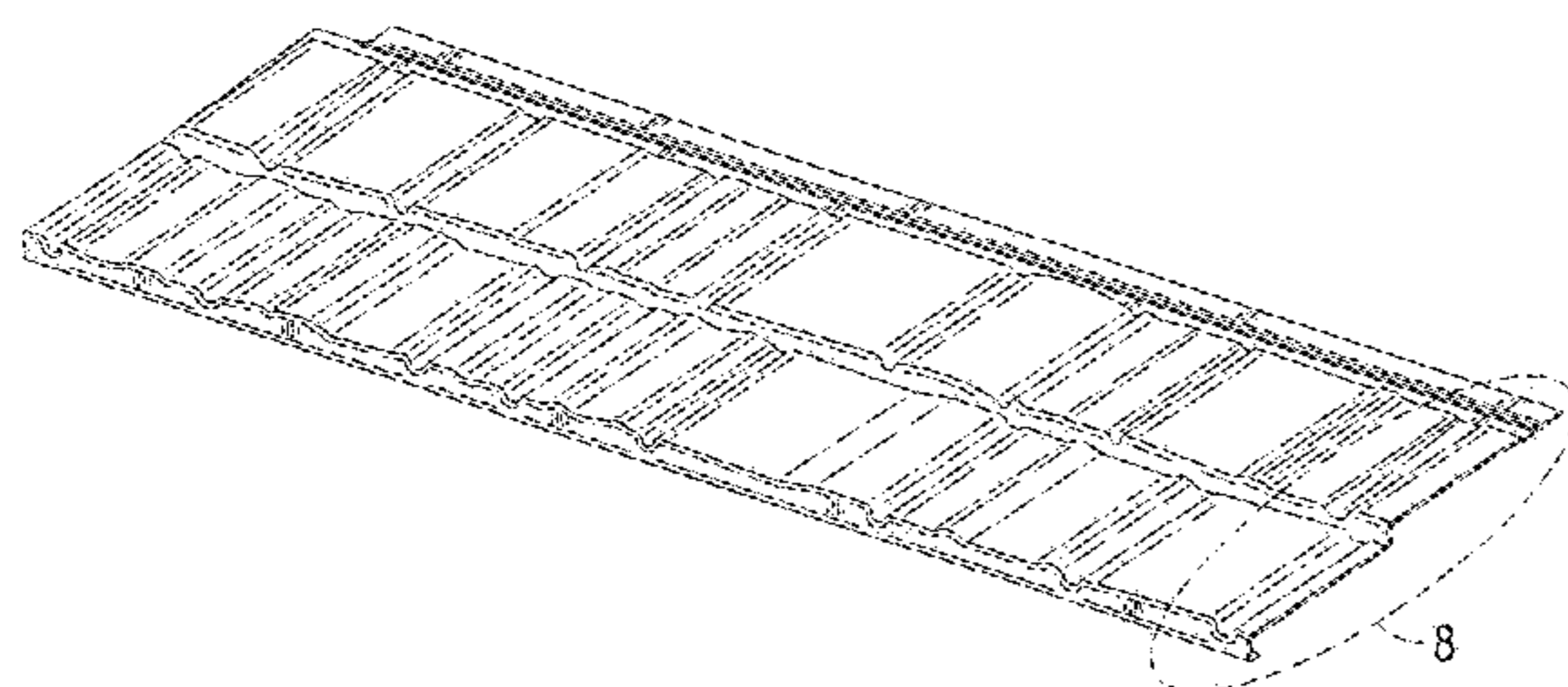

(56)

**References Cited**

U.S. PATENT DOCUMENTS

D462,129	S *	8/2002	Sadosky, Jr. ....	D25/141
RE38,210	E	8/2003	Plath et al.	
6,647,687	B2	11/2003	Kern	
6,737,008	B2 *	5/2004	Gilbert .....	B29C 51/24 264/151
6,772,569	B2	8/2004	Bennett et al.	
6,857,239	B2 *	2/2005	Sadosky, Jr. ....	B32B 3/12 52/311.1
6,907,701	B2	6/2005	Smith	
7,296,989	B2 *	11/2007	King .....	B29C 51/24 425/326.1
7,739,848	B2	6/2010	Trout	
7,775,009	B2 *	8/2010	King .....	E04F 13/0864 52/520
D643,133	S	8/2011	Steffes et al.	
D707,856	S	6/2014	Cochrane	
8,863,461	B2 *	10/2014	Wagner .....	E04F 13/0837 52/314
9,091,086	B2 *	7/2015	Michalski .....	E04F 13/0894
D738,541	S *	9/2015	Tarvaran .....	D25/140
D754,885	S *	4/2016	Rasmussen .....	D25/139
D765,272	S *	8/2016	Anderson .....	D25/141
D776,833	S *	1/2017	Rasmussen .....	D25/139
9,689,164	B2 *	6/2017	Rasmussen .....	E04D 1/265
9,797,144	B2 *	10/2017	Maurer .....	E04F 13/0846
2007/0137132	A1	6/2007	Plowright	
2016/0222667	A1 *	8/2016	Anderson .....	E04D 1/30

\* cited by examiner

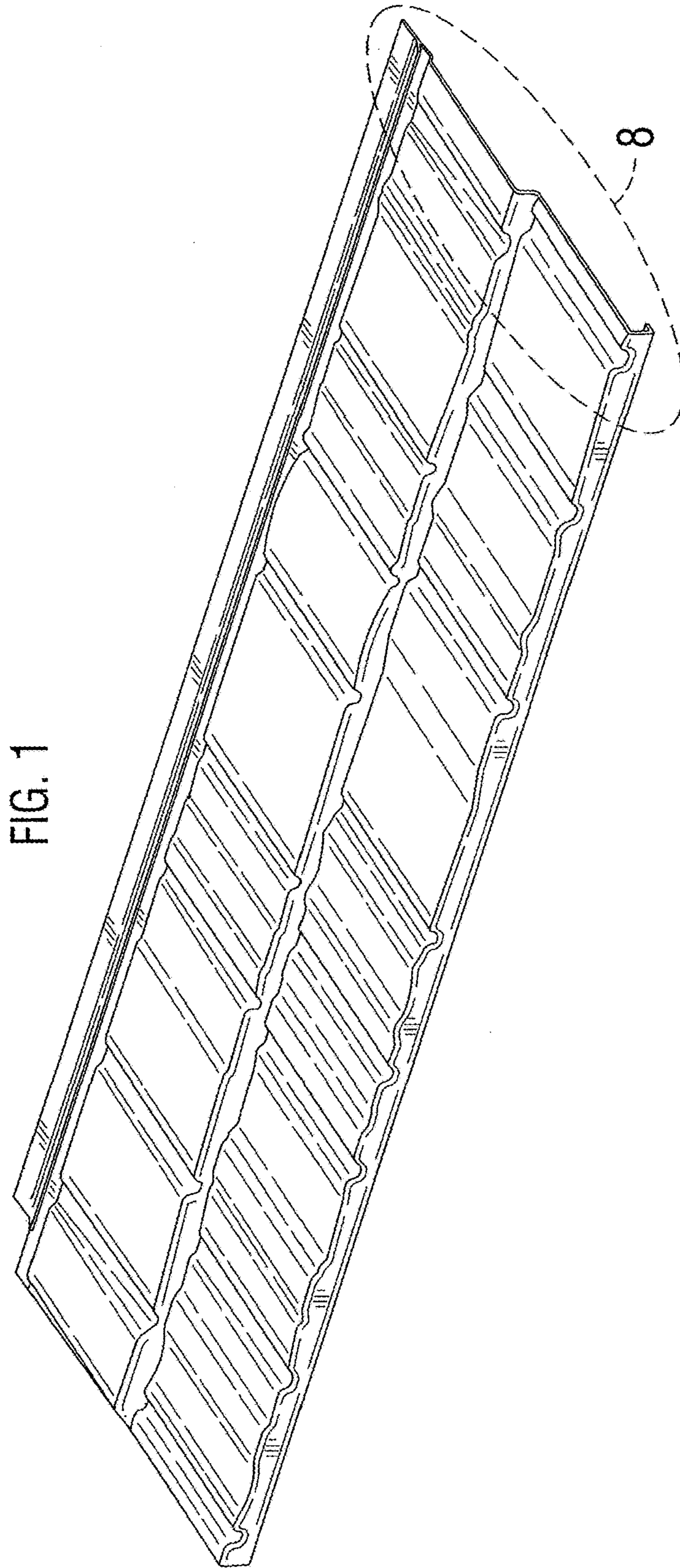

FIG. 4



FIG. 2

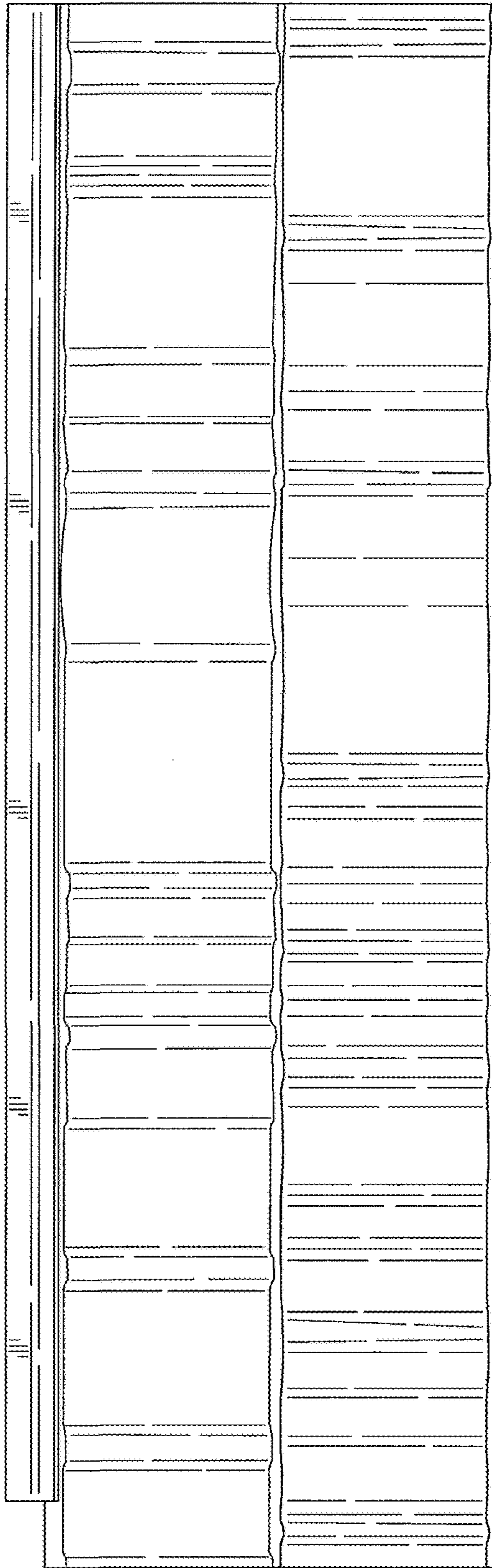

FIG. 5



FIG. 3

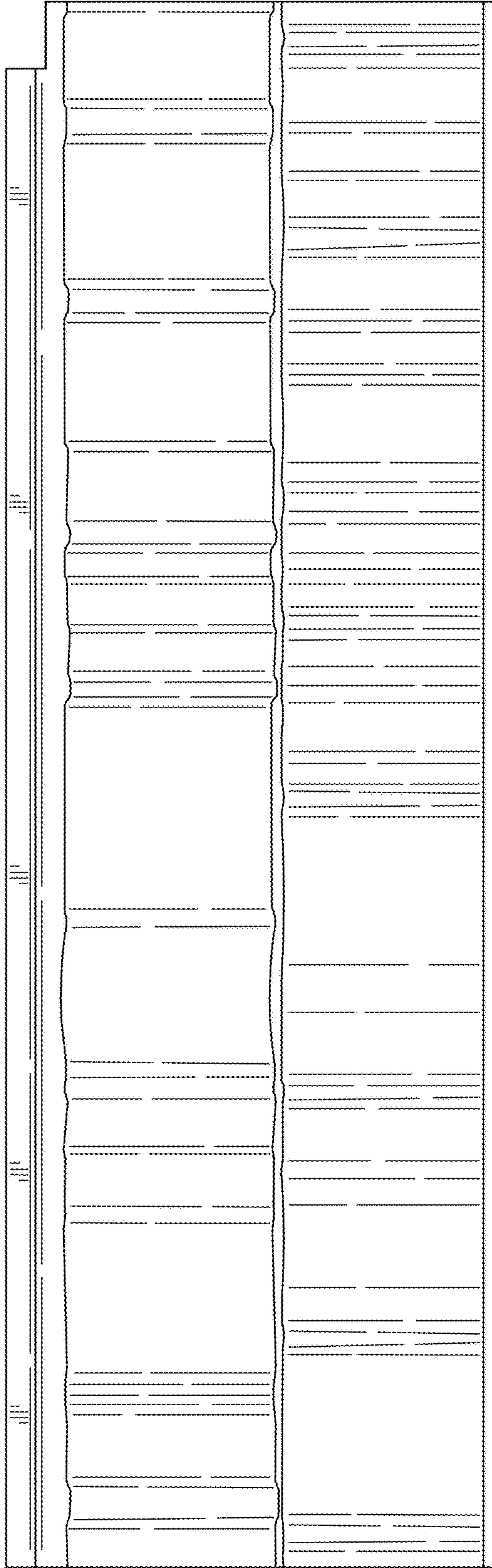

FIG. 6

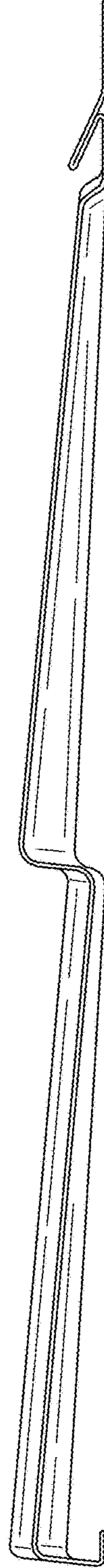

FIG. 7

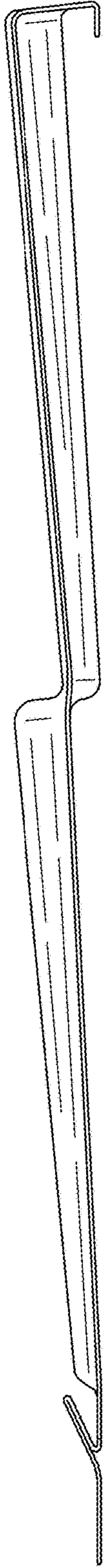

FIG. 8

