



US00D827156S

(12) **United States Design Patent** (10) **Patent No.:** **US D827,156 S**  
**Rossi** (45) **Date of Patent:** **\*\* Aug. 28, 2018**

(54) **CONCRETE BLOCK**  
(71) Applicant: **Dominique Rossi**, Nice (FR)  
(72) Inventor: **Dominique Rossi**, Nice (FR)  
(\*\*) Term: **15 Years**  
(21) Appl. No.: **35/501,610**

D408,557 S \* 4/1999 Behunin ..... D25/114  
D408,930 S \* 4/1999 Behunin ..... D25/114  
D409,313 S \* 5/1999 Behunin ..... D25/114  
D509,597 S \* 9/2005 Yanagisawa ..... D25/115  
D574,517 S \* 8/2008 Foster ..... D25/113  
D602,171 S \* 10/2009 Rodebaugh ..... D25/113  
D776,832 S \* 1/2017 Gibson ..... D25/118  
D783,860 S \* 4/2017 Mugge ..... D25/113  
D783,861 S \* 4/2017 Mugge ..... D25/113

\* cited by examiner

(22) Filed: **Aug. 3, 2016**

*Primary Examiner* — Darlington Ly

(80) **Hague Agreement Data**

(74) *Attorney, Agent, or Firm* — Ladas & Parry LLP;  
Malcolm J. MacDonald

Int. Filing Date: **Aug. 3, 2016**  
Int. Reg. No.: **DM/092424**  
Int. Reg. Date: **Aug. 3, 2016**  
Int. Reg. Pub. Date: **Sep. 23, 2016**

(51) **LOC (11) Cl.** ..... **25-01**

(57) **CLAIM**

(52) **U.S. Cl.**

The ornamental design for a concrete block, as shown and described.

USPC ..... **D25/113**

(58) **Field of Classification Search**

**DESCRIPTION**

USPC ..... D21/484–486, 489–491, 500–502;  
D25/102, 113–118, 133, 164  
CPC ..... E04B 1/625; E04B 1/5837; E04B  
2001/5887; E04F 13/007; E04F 13/0871;  
E04F 13/14; E04F 13/22; E04F 13/24  
See application file for complete search history.

1. Concrete block  
**1.1** is a front elevation view of a concrete block showing my new design;  
**1.2** is a top plan view thereof;  
**1.3** is a left side elevation view thereof;  
**1.4** is a right side elevation view thereof;  
**1.5** is a bottom plan view thereof;  
**1.6** is a perspective view thereof; and  
**1.7** is a perspective view taken from an alternate position.

(56) **References Cited**

**U.S. PATENT DOCUMENTS**

D340,775 S \* 10/1993 Sauve ..... D25/118  
D368,313 S \* 3/1996 Schulz, Jr. .... D25/118

**1 Claim, 7 Drawing Sheets**

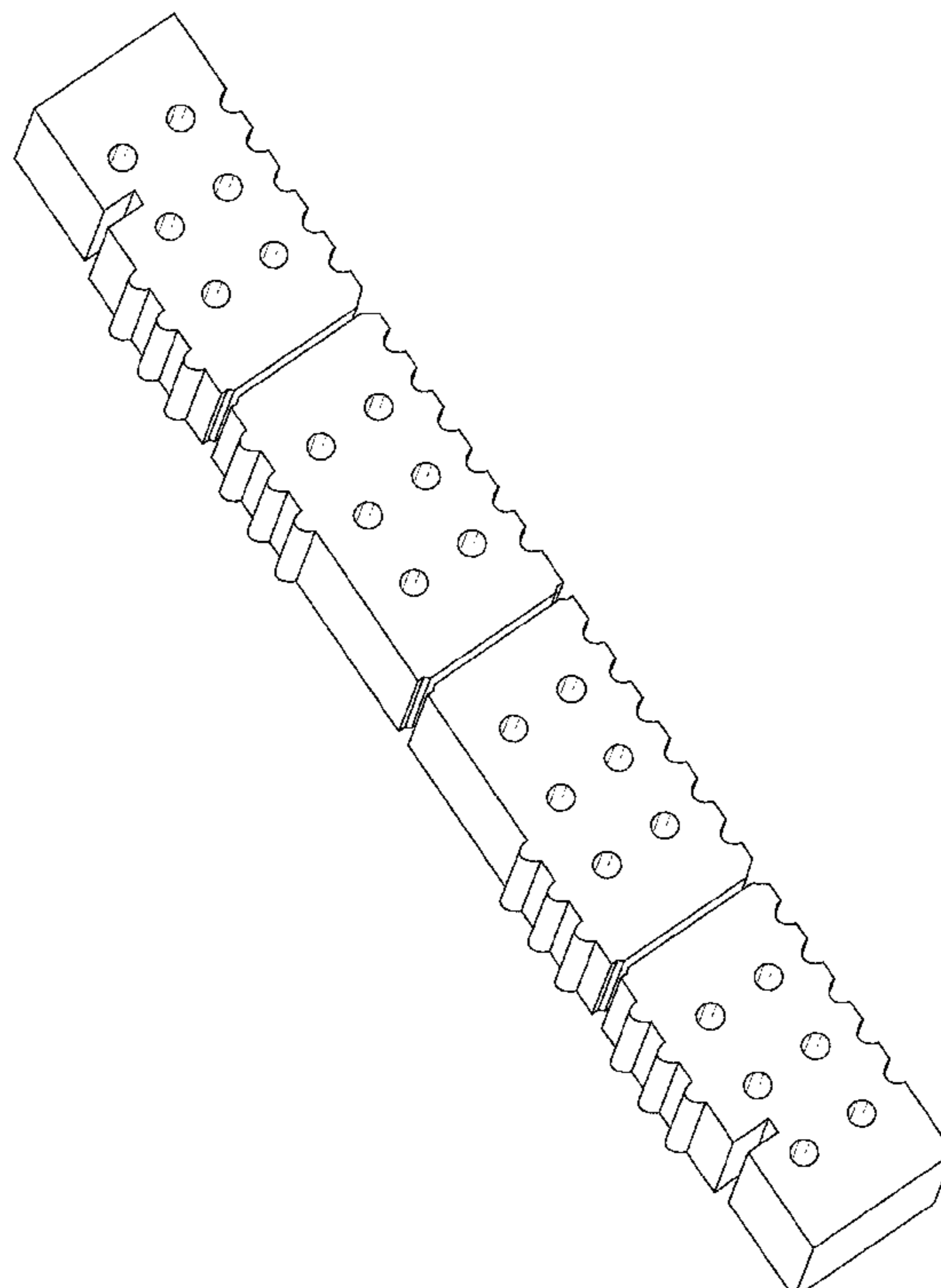

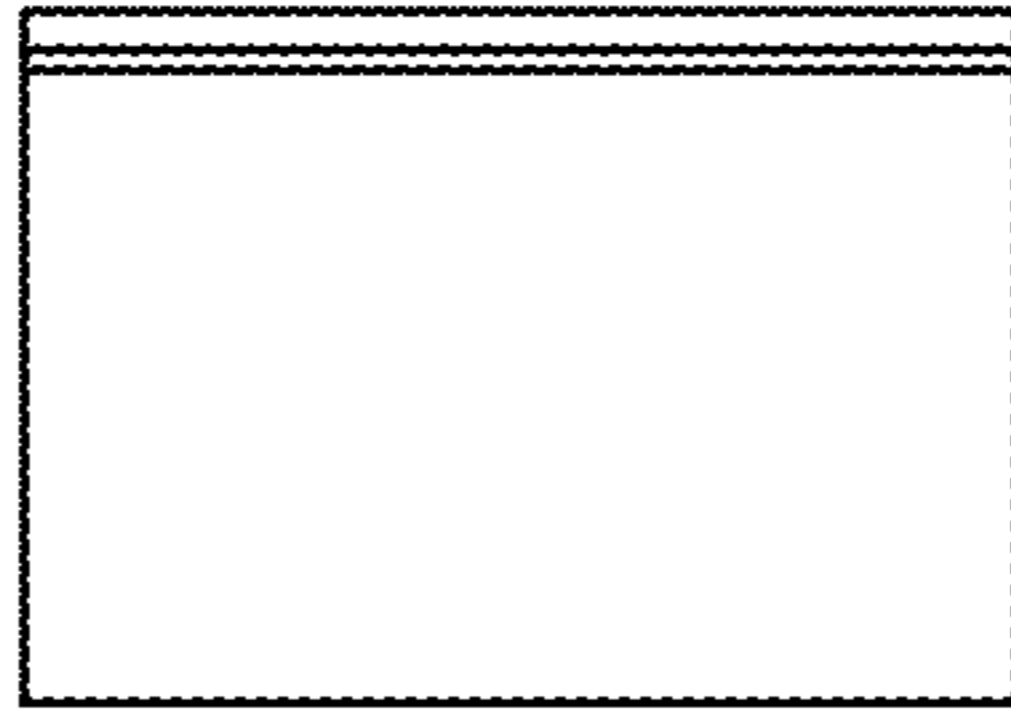

**1.1**

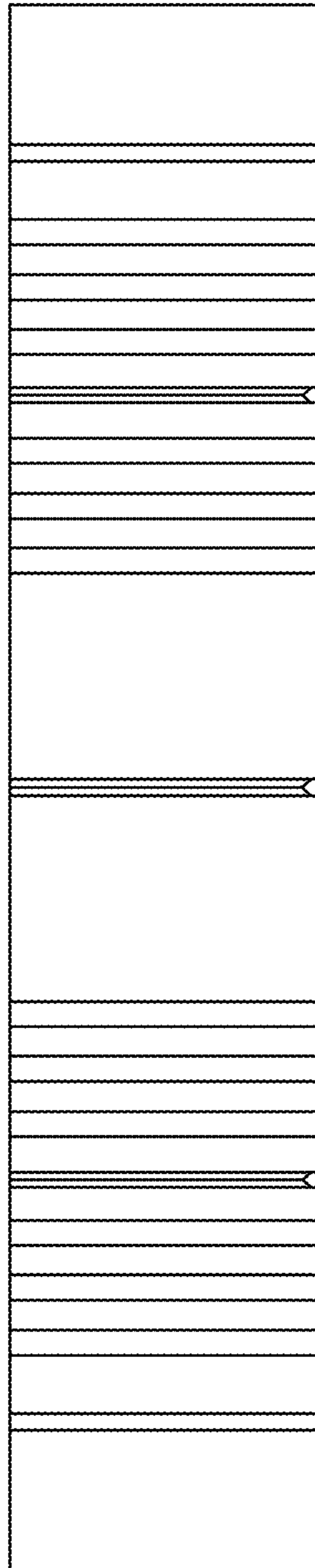

1.2

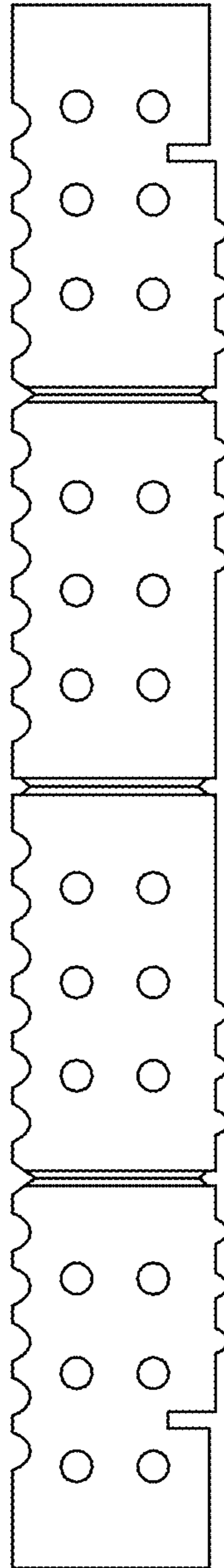

1.3

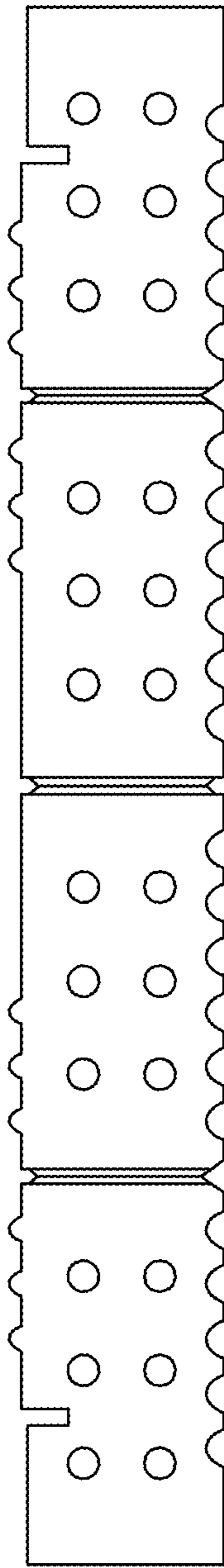

1.4

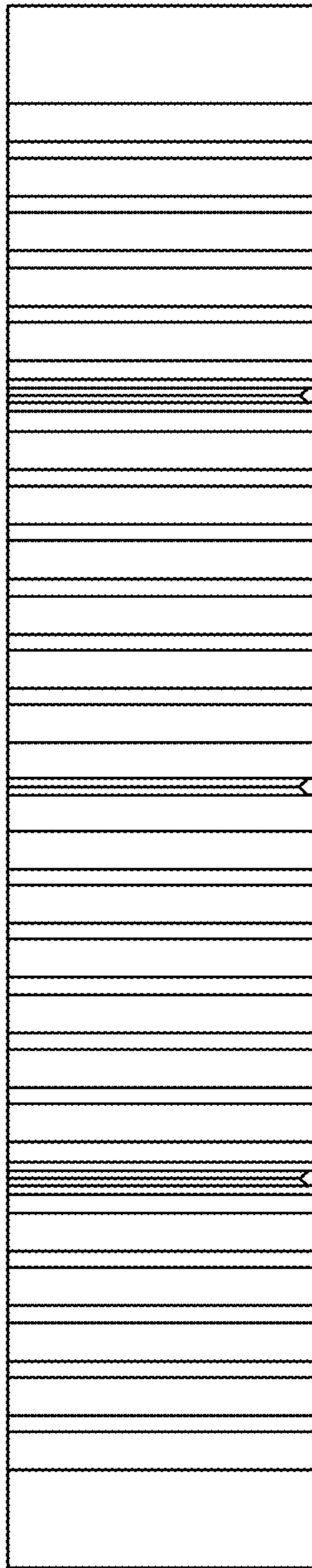

1.5

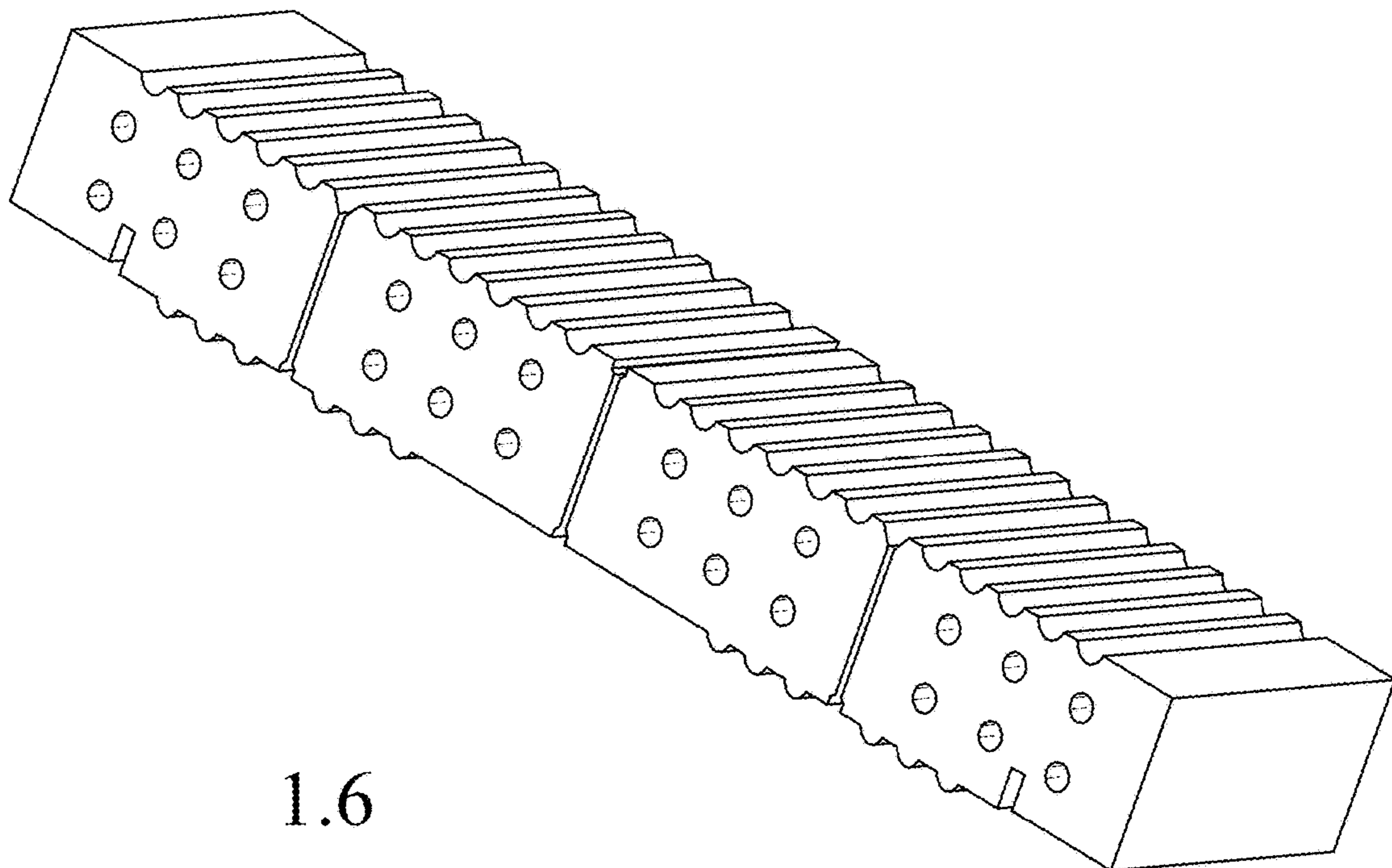

1.6

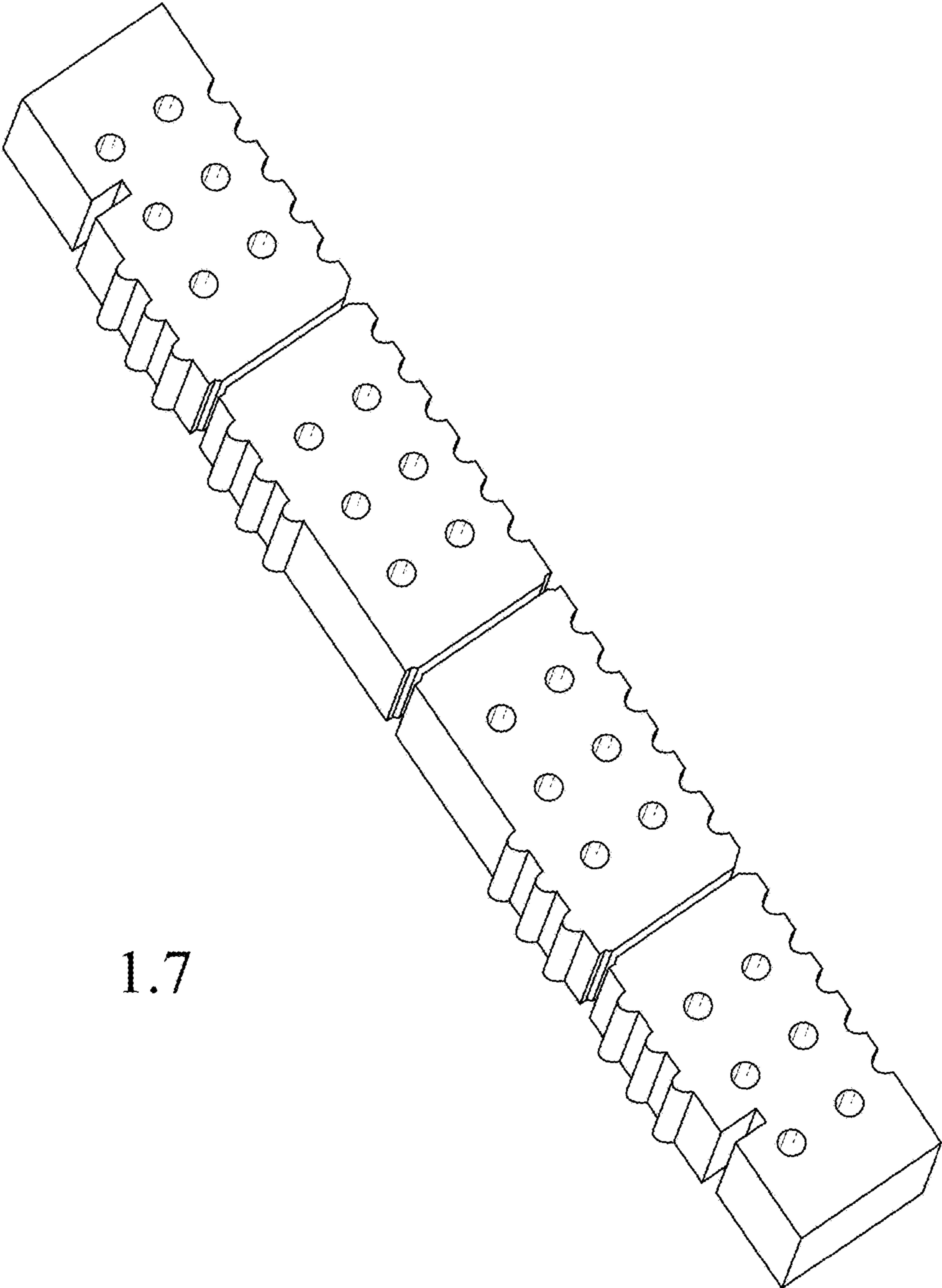

1.7