



US00D827145S

(12) **United States Design Patent** (10) **Patent No.:** **US D827,145 S**
Lee (45) **Date of Patent:** **** Aug. 28, 2018**

(54) **LIGHT-MAGNETISM HARMONIZER**
(71) Applicant: **Chung-Ming Lee**, Taichung (TW)
(72) Inventor: **Wen-Pin Lee**, Taichung (TW)
(73) Assignee: **Chung-Ming Lee**, Taichung (TW)
(**) Term: **15 Years**
(21) Appl. No.: **29/613,298**
(22) Filed: **Aug. 9, 2017**
(51) **LOC (11) Cl.** **28-03**
(52) **U.S. Cl.**
USPC **D24/209**
(58) **Field of Classification Search**
USPC D24/107, 158, 185, 186, 188, 200, 209,
D24/210, 213, 215, 231; D26/93, 104,
D26/63
CPC A61N 2/002; A61N 2/006; A61N 5/06;
A61N 2005/0654; A61N 2005/0659
See application file for complete search history.

D774,658 S * 12/2016 Andersen D24/210
D788,344 S * 5/2017 Gecchelin D26/63
D797,302 S * 9/2017 Vahlensieck D24/209
D799,093 S * 10/2017 Terumichi D26/63
D810,955 S * 2/2018 Miklavc D24/215
2015/0335911 A1* 11/2015 Rogers A61N 5/0616
607/88

* cited by examiner

Primary Examiner — Anhdao Doan

(74) *Attorney, Agent, or Firm* — Muncy, Geissler, Olds & Lowe, P.C.

(57) **CLAIM**

I claim the ornamental design for a light-magnetism harmonizer, as shown and described.

DESCRIPTION

FIG. 1 is a front, right, and top perspective view of a light-magnetism harmonizer showing my new design; FIG. 2 is a front elevational view thereof; FIG. 3 is a rear elevational view thereof; FIG. 4 is a left side view thereof; FIG. 5 is a right side view thereof; FIG. 6 is a top plan view thereof; FIG. 7 is a bottom plan view thereof; FIG. 8 is a cross-sectional view of the light-magnetism harmonizer, taken along line 8-8 in FIG. 6. thereof; and, FIG. 9 is a left, front, and bottom perspective view. The broken lines in the drawings illustrate portions of the light-magnetism harmonizer which form no part of the claimed design.

1 Claim, 9 Drawing Sheets

(56) **References Cited**

U.S. PATENT DOCUMENTS

D392,407 S * 3/1998 Johnson D26/104
D400,258 S * 10/1998 Bolleter D24/210
6,589,159 B2 * 7/2003 Paturu A61N 2/06
600/15
D509,300 S * 9/2005 Muller D24/209
D520,143 S * 5/2006 Yoneda D24/209
7,361,917 B2 * 4/2008 Yabiku A61N 5/06
250/504 R
D691,278 S * 10/2013 Aunio D24/210

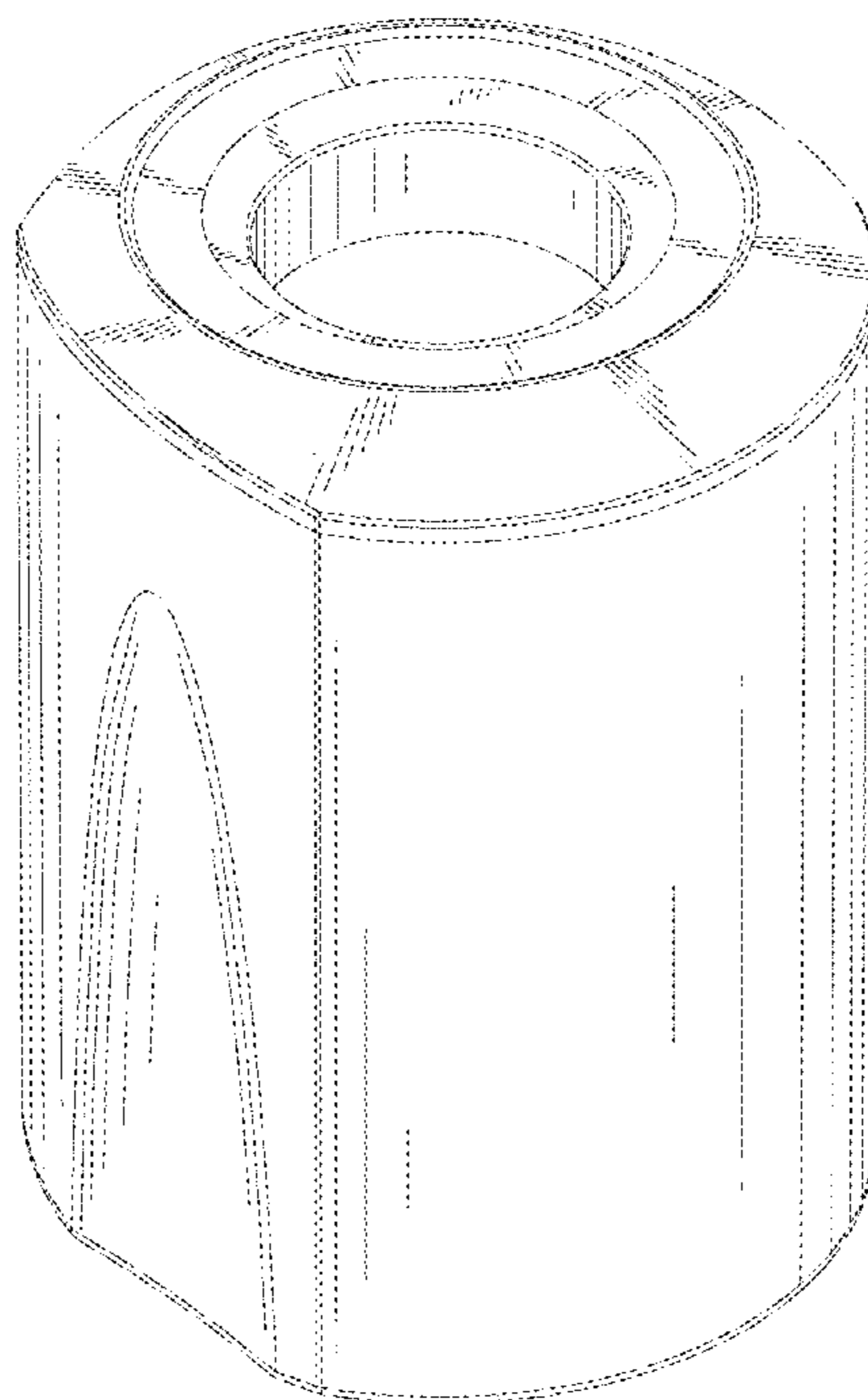

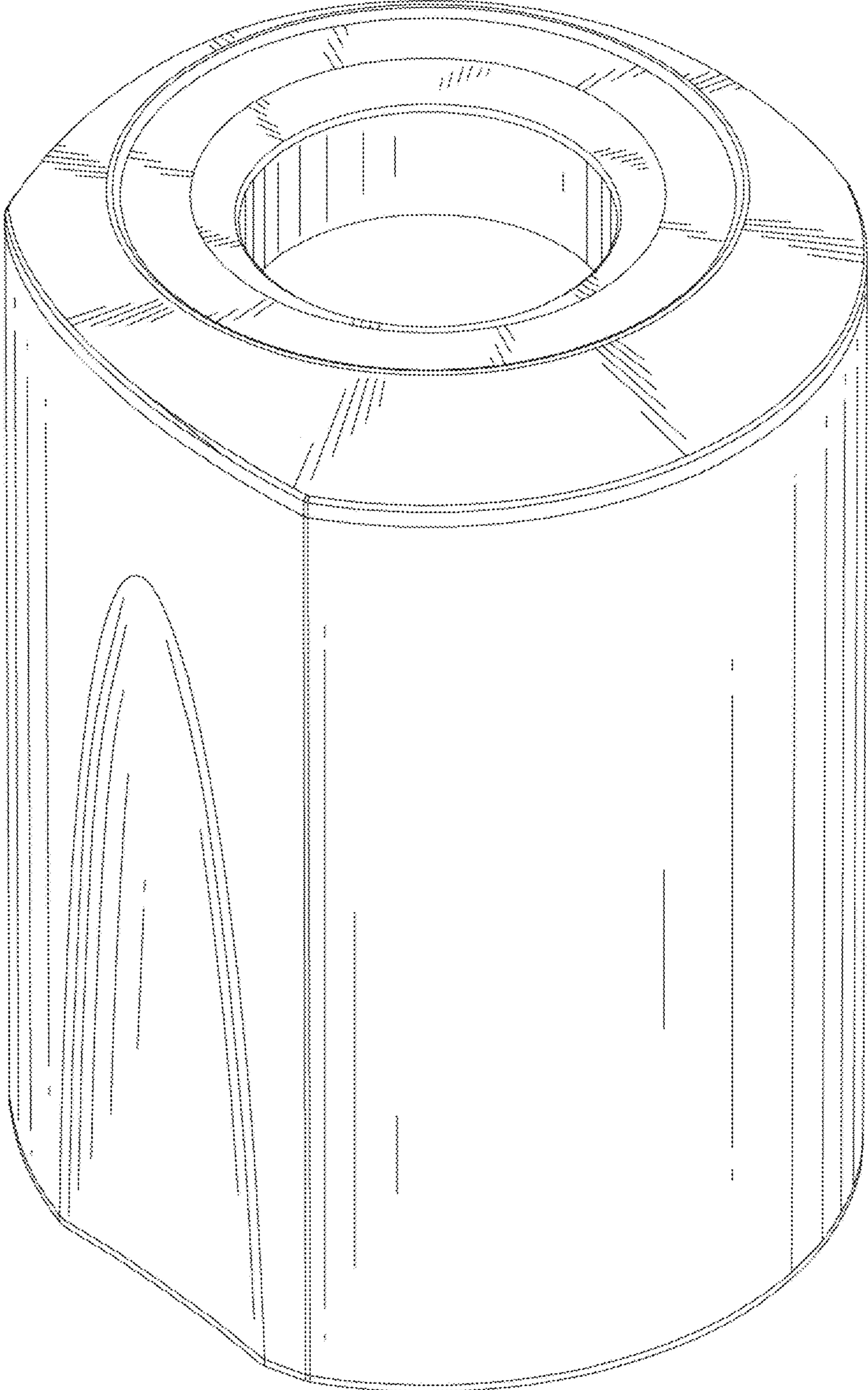

FIG. 1

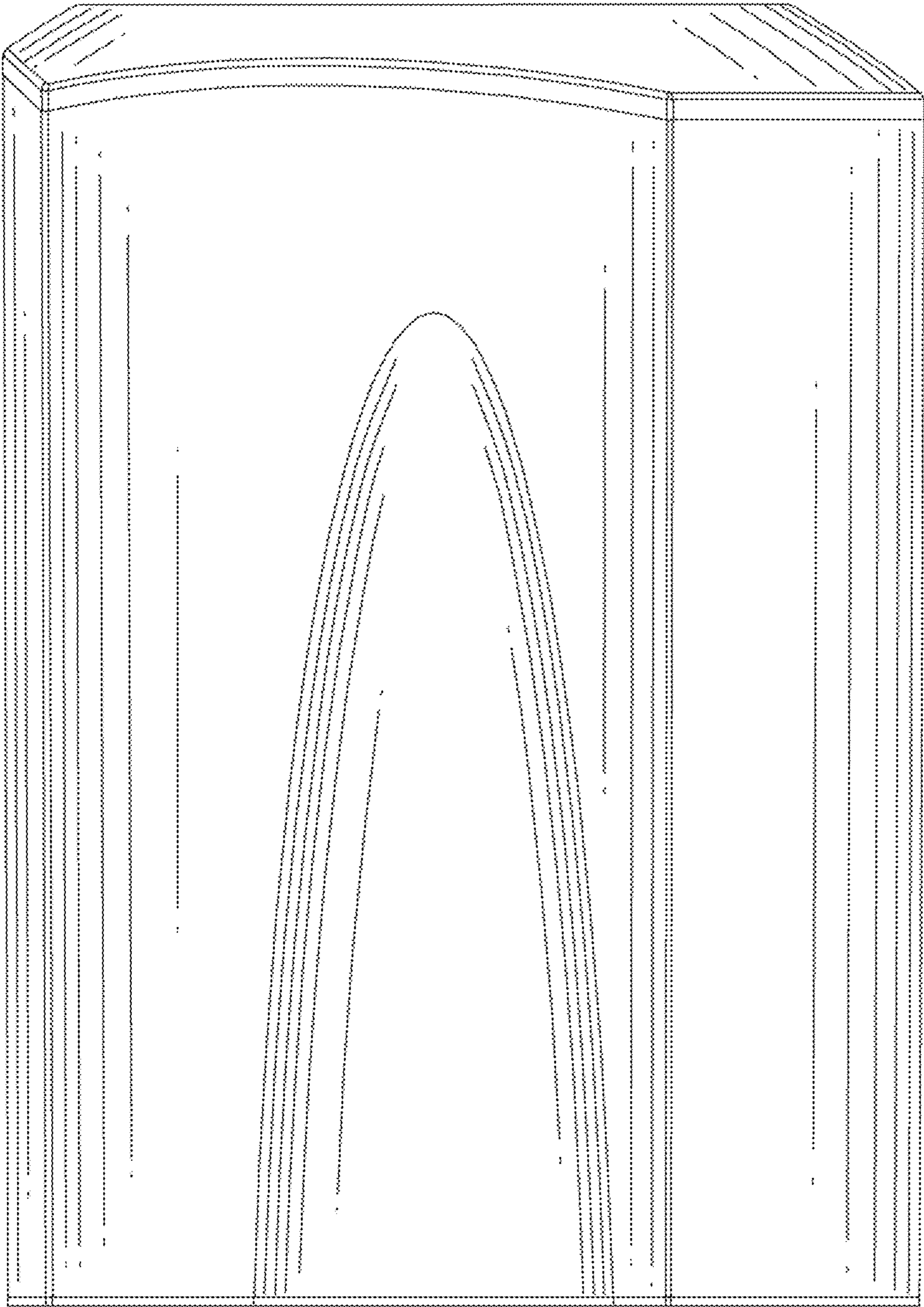

FIG. 2

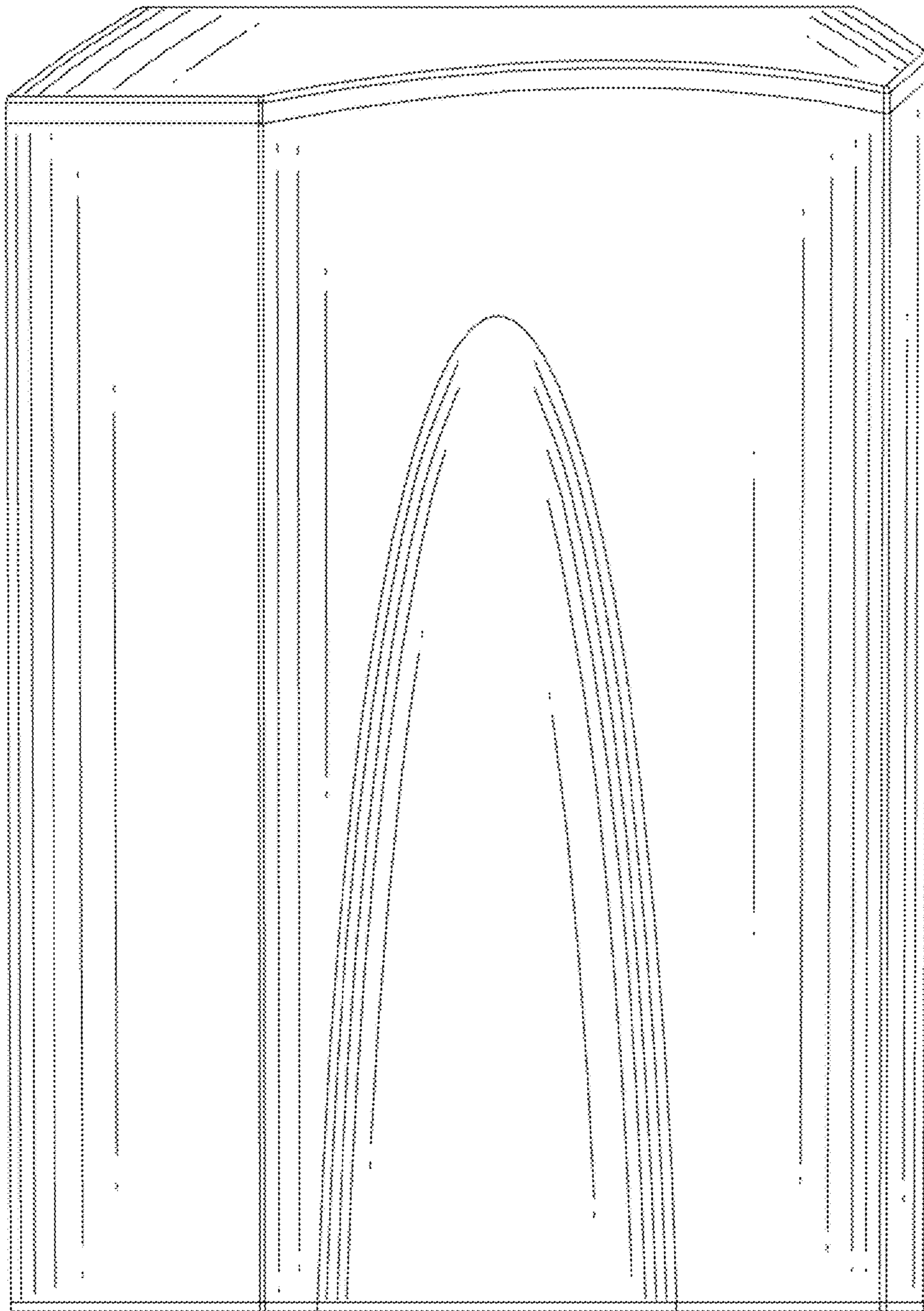

FIG. 3

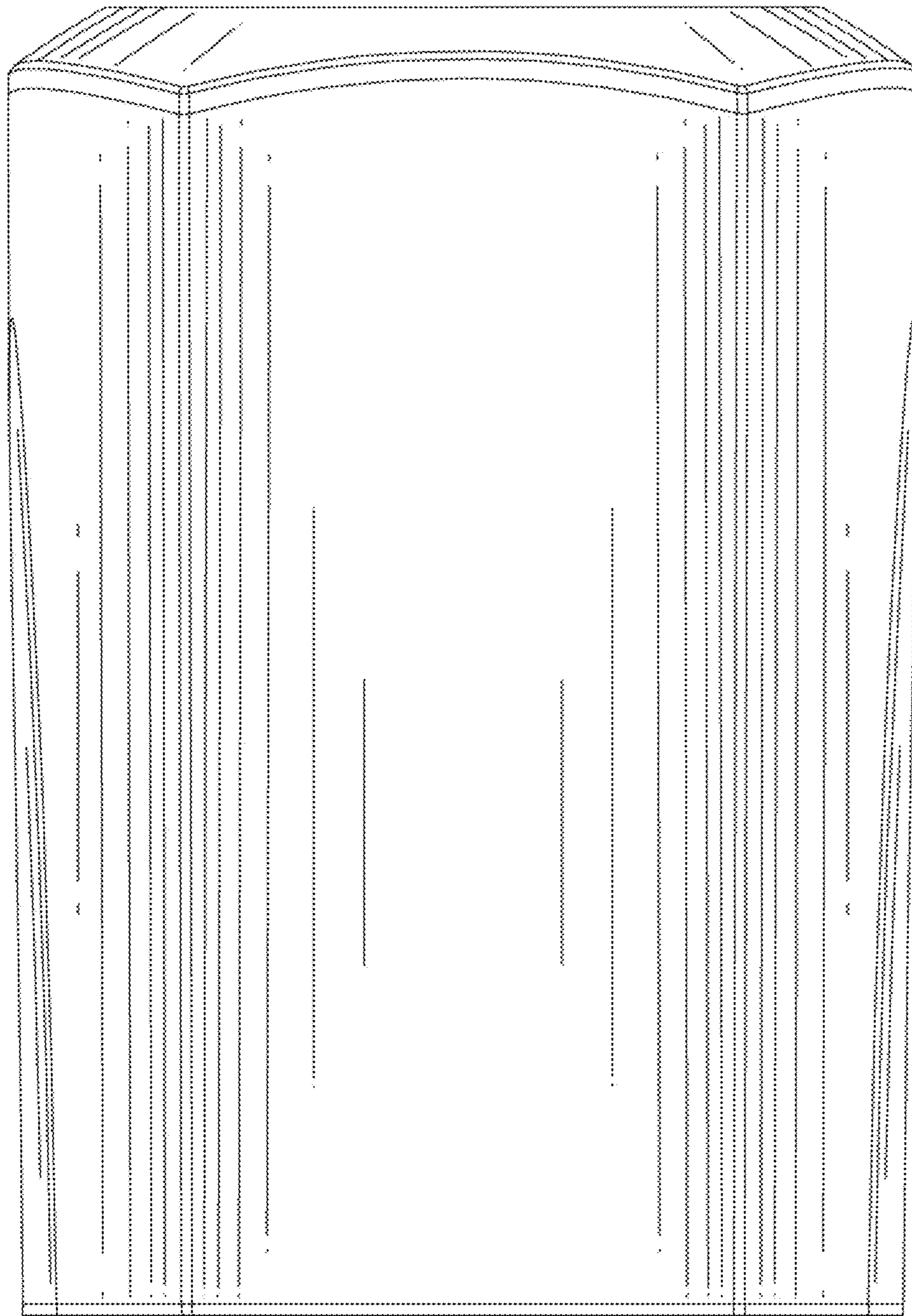

FIG. 4

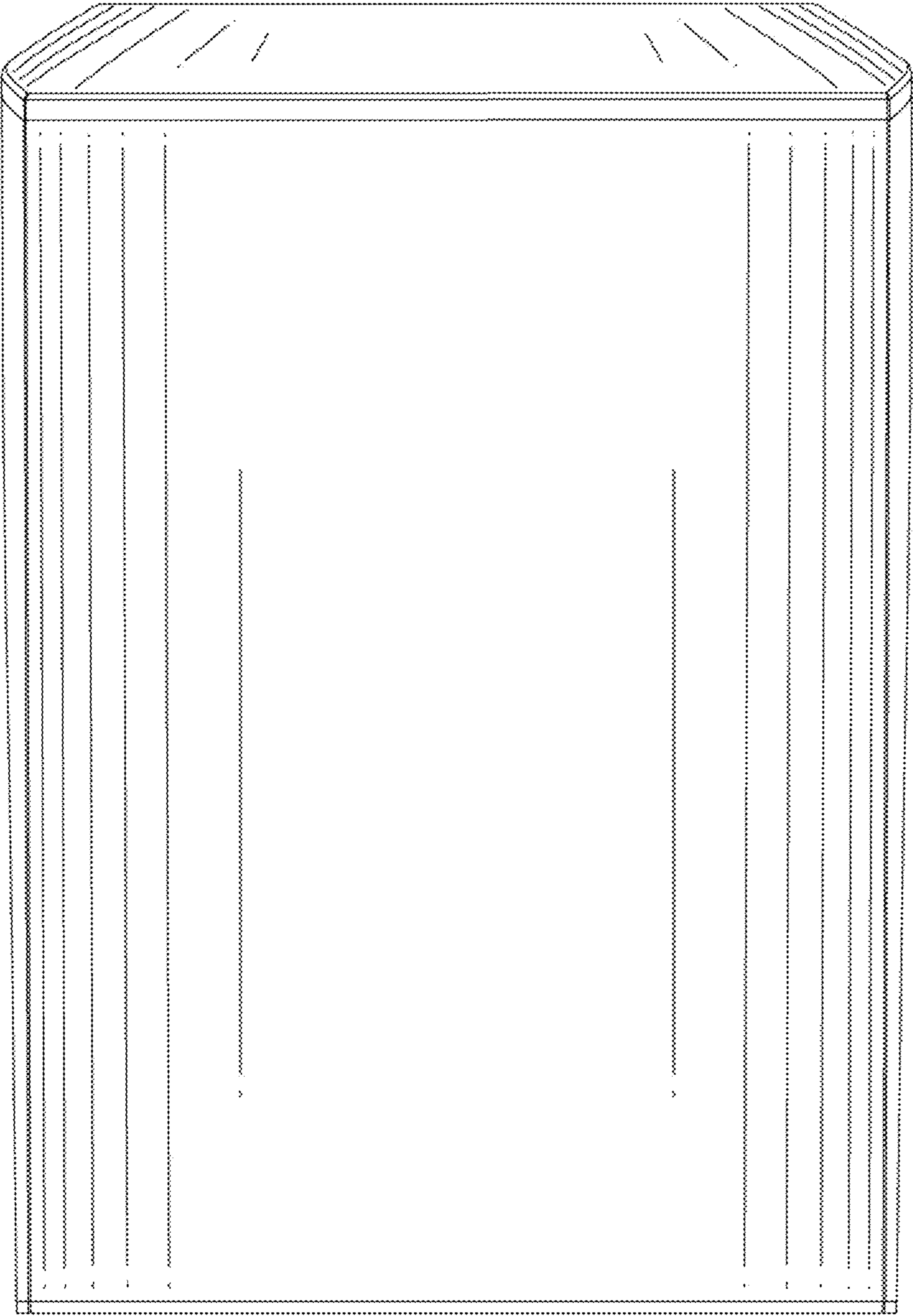

FIG. 5

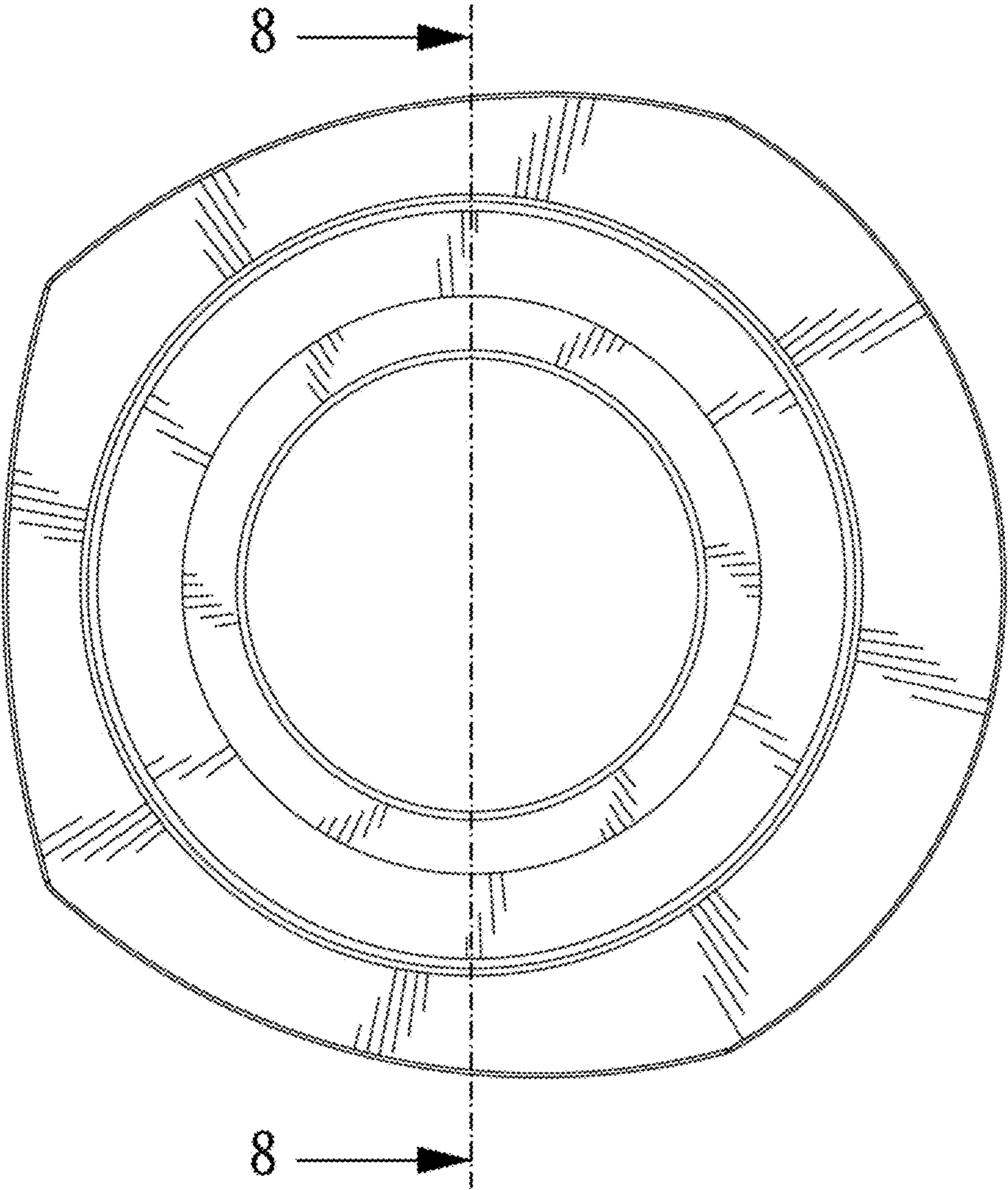

FIG. 6

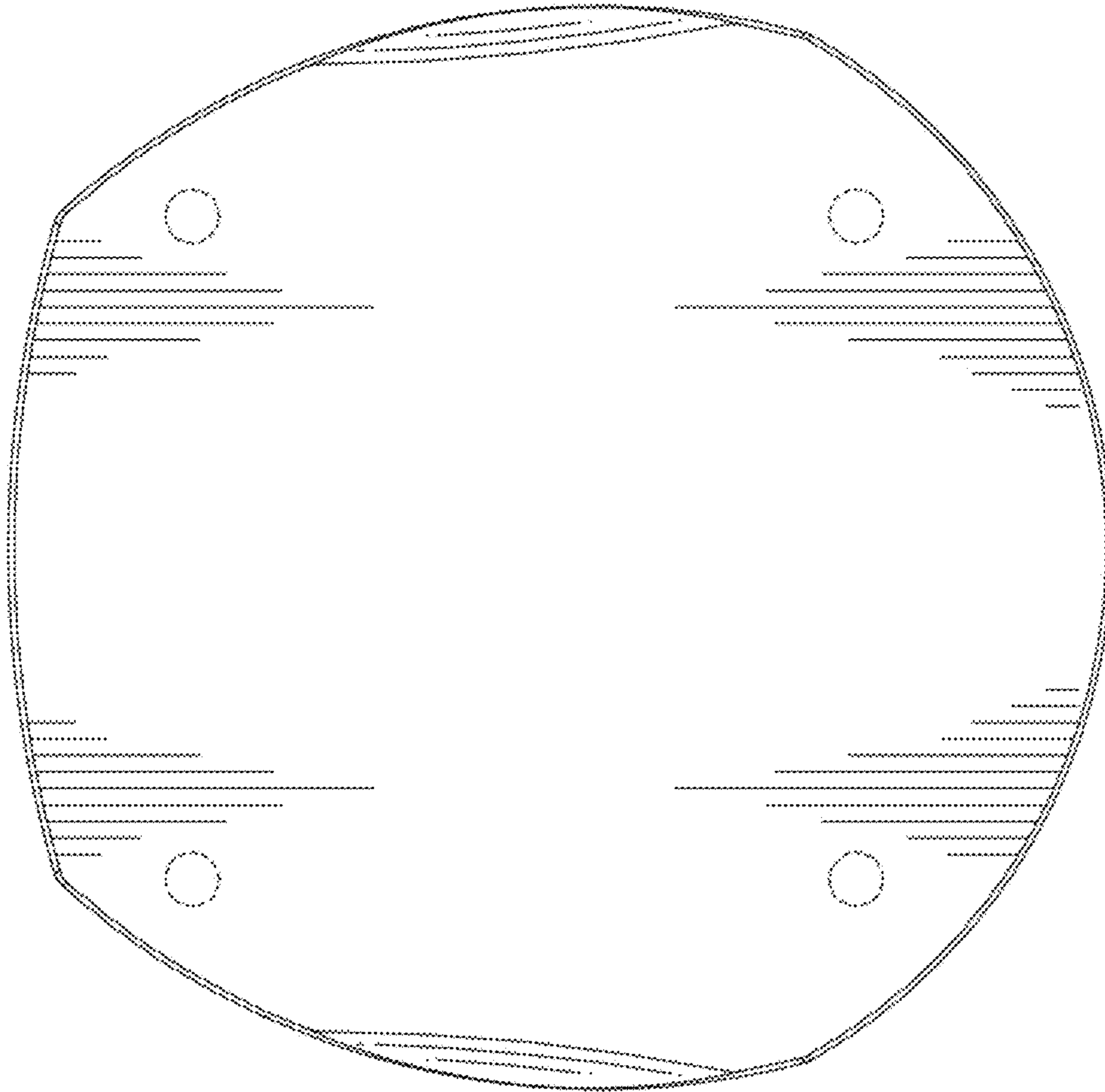

FIG. 7

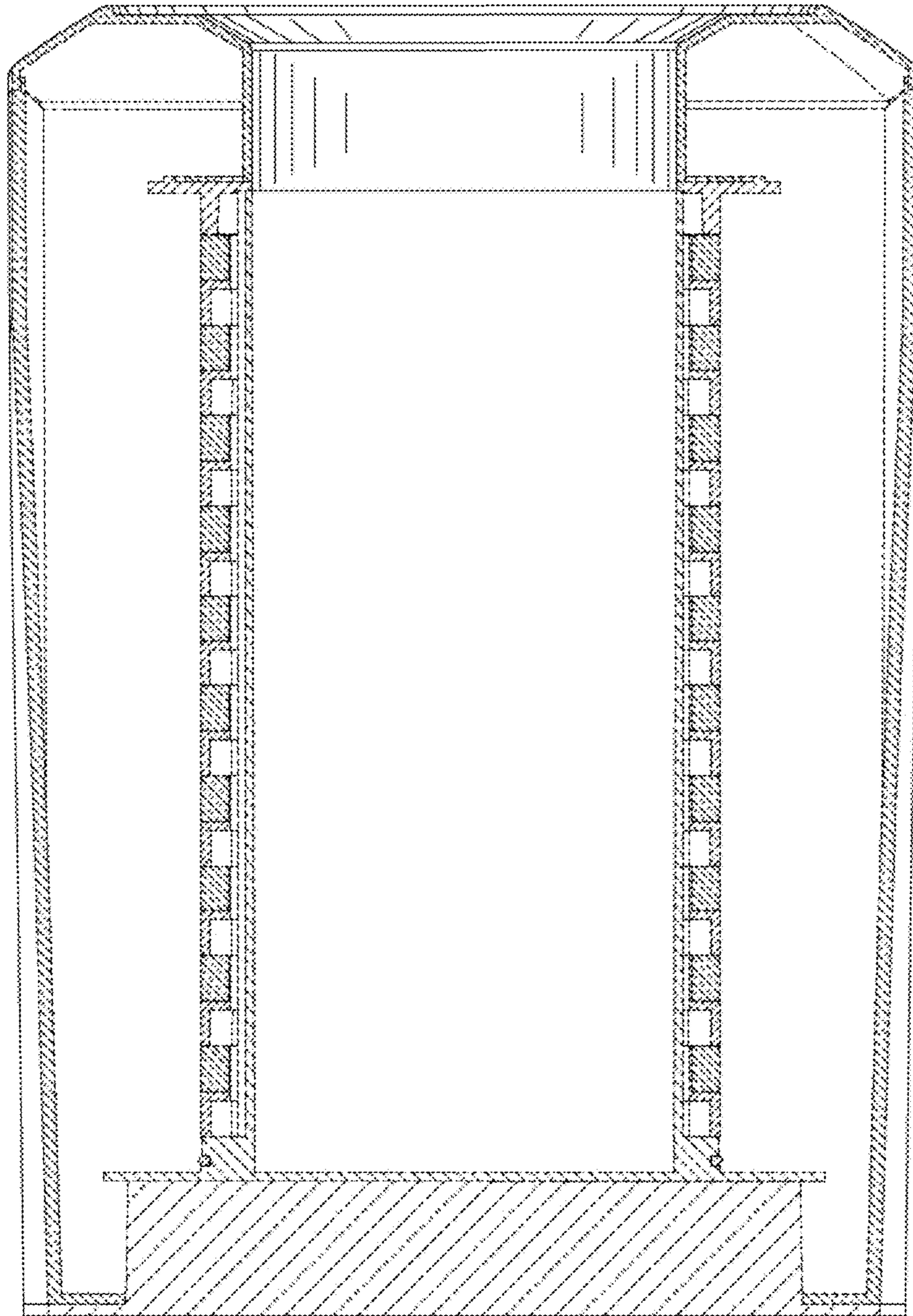

FIG. 8

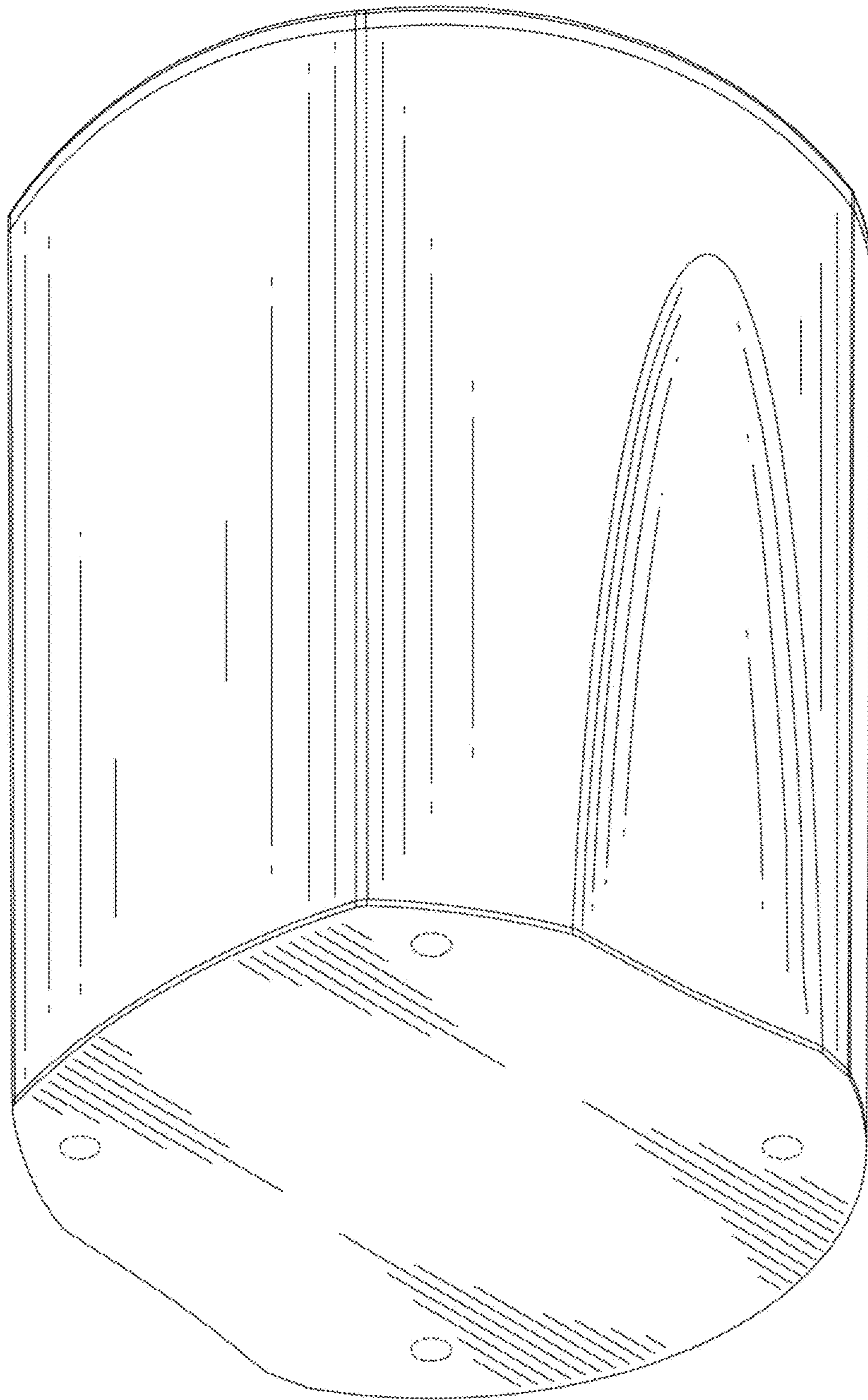

FIG. 9