



US00D827080S

(12) **United States Design Patent**
Bottome et al.

(10) **Patent No.:** **US D827,080 S**
(45) **Date of Patent:** **** Aug. 28, 2018**

(54) **HANGING POD**

(71) Applicant: **Canaima Outdoors, Inc.**, Boulder, CO (US)

(72) Inventors: **Ricardo Bottome**, Boulder, CO (US);
Michael Cecot-Scherer, Louisville, CO (US)

(73) Assignee: **Canaima Outdoors, Inc.**, Boulder, CO (US)

(**) Term: **15 Years**

(21) Appl. No.: **29/593,670**

(22) Filed: **Feb. 10, 2017**

(51) **LOC (11) Cl.** **21-04**

(52) **U.S. Cl.**
USPC **D21/834**

(58) **Field of Classification Search**
USPC D21/834, 835, 836, 837, 838, 839, 840
CPC E04H 15/00; E04H 15/02; E04H 15/18;
E04H 15/28; E04H 15/32; E04H 15/34;
E04H 15/40; E04H 15/42; E04H 15/425;
E04H 15/50
See application file for complete search history.

(56) **References Cited**

U.S. PATENT DOCUMENTS

3,545,461	A *	12/1970	Carlson	E04H 15/04 135/100
4,265,261	A *	5/1981	Barker	E04H 15/24 135/100
4,320,542	A	3/1982	Cohen		
4,526,307	A	7/1985	Parker		
4,825,578	A	5/1989	Robinson		
5,042,517	A	8/1991	Stewart		
5,078,096	A	1/1992	Bishop		
5,362,017	A	11/1994	Puckett		
5,732,726	A *	3/1998	Lee	E04H 15/42 135/114
D397,756	S *	9/1998	Hagerty	D21/811

6,877,521 B2 4/2005 Webster et al.
7,051,385 B2 5/2006 Gardner
D594,080 S * 6/2009 Flem D21/834
(Continued)

OTHER PUBLICATIONS

HugglePod, <http://www.hearthsong.com/nylon-canvas-hugglepodhangout-with-led-lights.htm>.
(Continued)

Primary Examiner — Robin V Webster
Assistant Examiner — Keith J Wilson
(74) *Attorney, Agent, or Firm* — Lewis Brisbois Bisgaard & Smith LLP

(57) **CLAIM**

The ornamental design for a hanging pod, as shown and described.

DESCRIPTION

FIG. 1 is a perspective view of a hanging pod, showing our new design;
FIG. 2 is a front elevation view of the hanging pod illustrated in FIG. 1;
FIG. 3 is a rear elevation view of the hanging pod illustrated in FIG. 1;
FIG. 4 is a right side elevation view of the hanging pod illustrated in FIG. 1;
FIG. 5 is a left side elevation view of the hanging pod illustrated in FIG. 1;
FIG. 6 is a top plan view of the hanging pod illustrated in FIG. 1; and,
FIG. 7 is a bottom plan view of the hanging pod illustrated in FIG. 1.
The broken lines depict portions of the hanging pod that form no part of the claimed design.
The broken lines and unshaded surfaces bounded by the broken lines form no part of the claimed design.

1 Claim, 7 Drawing Sheets

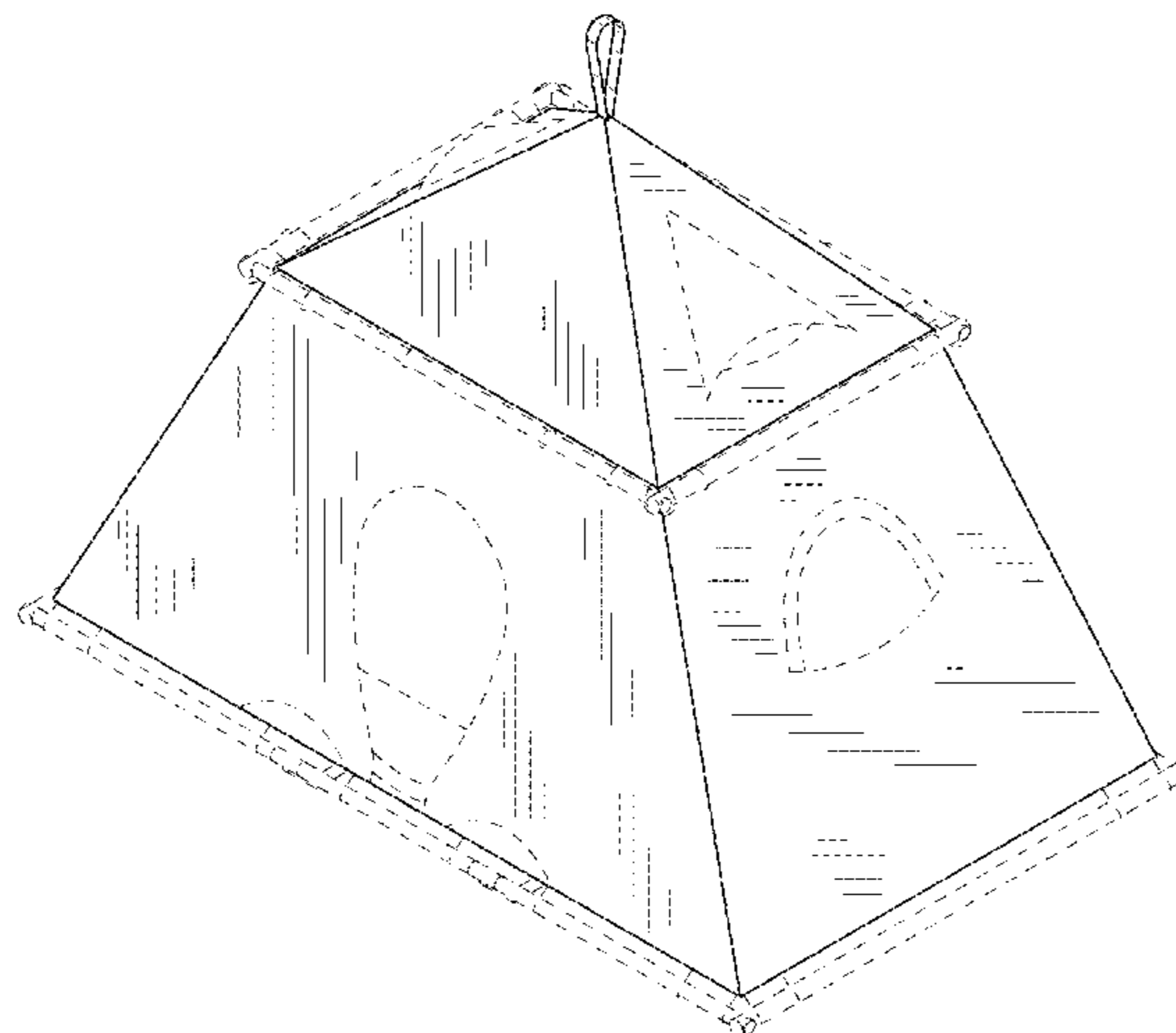

(56)

References Cited

U.S. PATENT DOCUMENTS

8,555,910 B2 10/2013 Webster et al.
8,695,859 B1 * 4/2014 Stalker A45F 3/04
135/901
9,140,030 B2 * 9/2015 Jin E04H 15/46
9,254,446 B2 2/2016 Lacy et al.
9,347,238 B2 * 5/2016 Dominick E04H 15/04
9,630,119 B2 * 4/2017 Fries A63H 33/008
2002/0189656 A1 12/2002 David
2004/0006820 A1 1/2004 Saiki
2010/0252083 A1 10/2010 Ogle

OTHER PUBLICATIONS

Tree Hammocks, <https://www.wayfair.com/outdoor/sb0/tree-hammocks-c1864033.html>.
“What is a Treepee®?” Live Life Outdoors International Ltd., © 2007, 2 pages [retrieved from: www.treepee.com].
Non-Final Office Action dated Oct. 19, 2017 for U.S. Appl. No. 15/429,853.

* cited by examiner

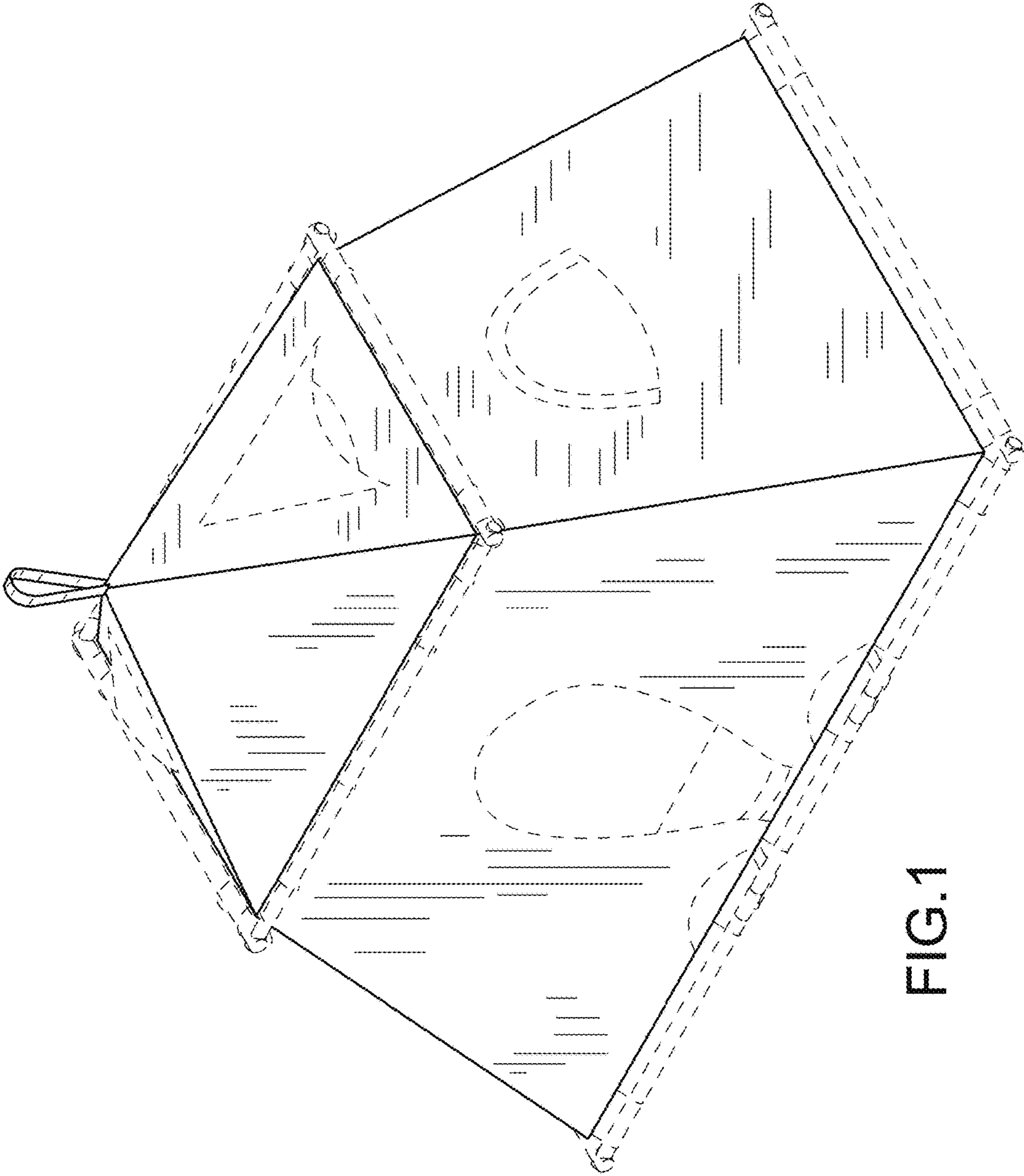

FIG.1

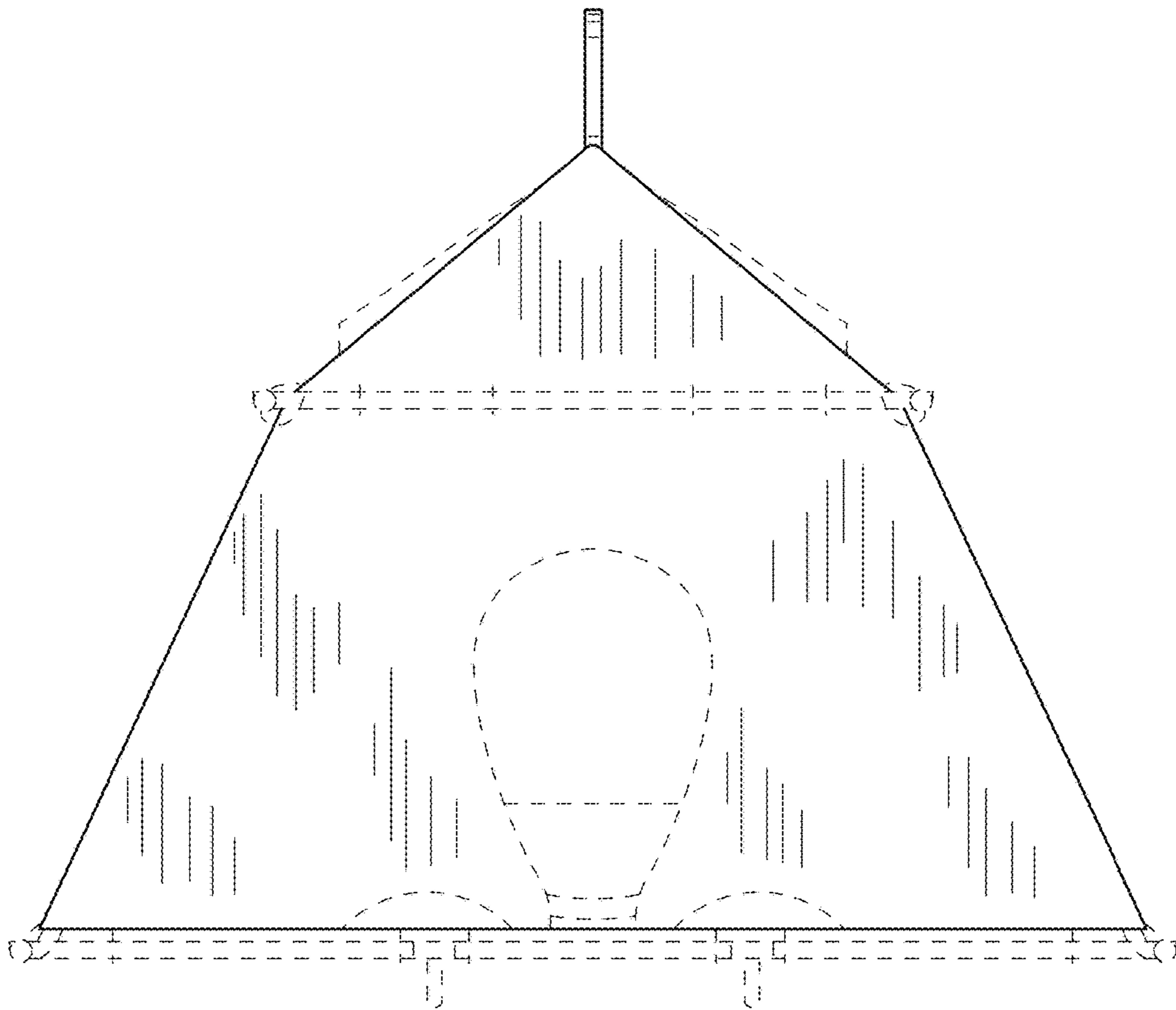

FIG.2

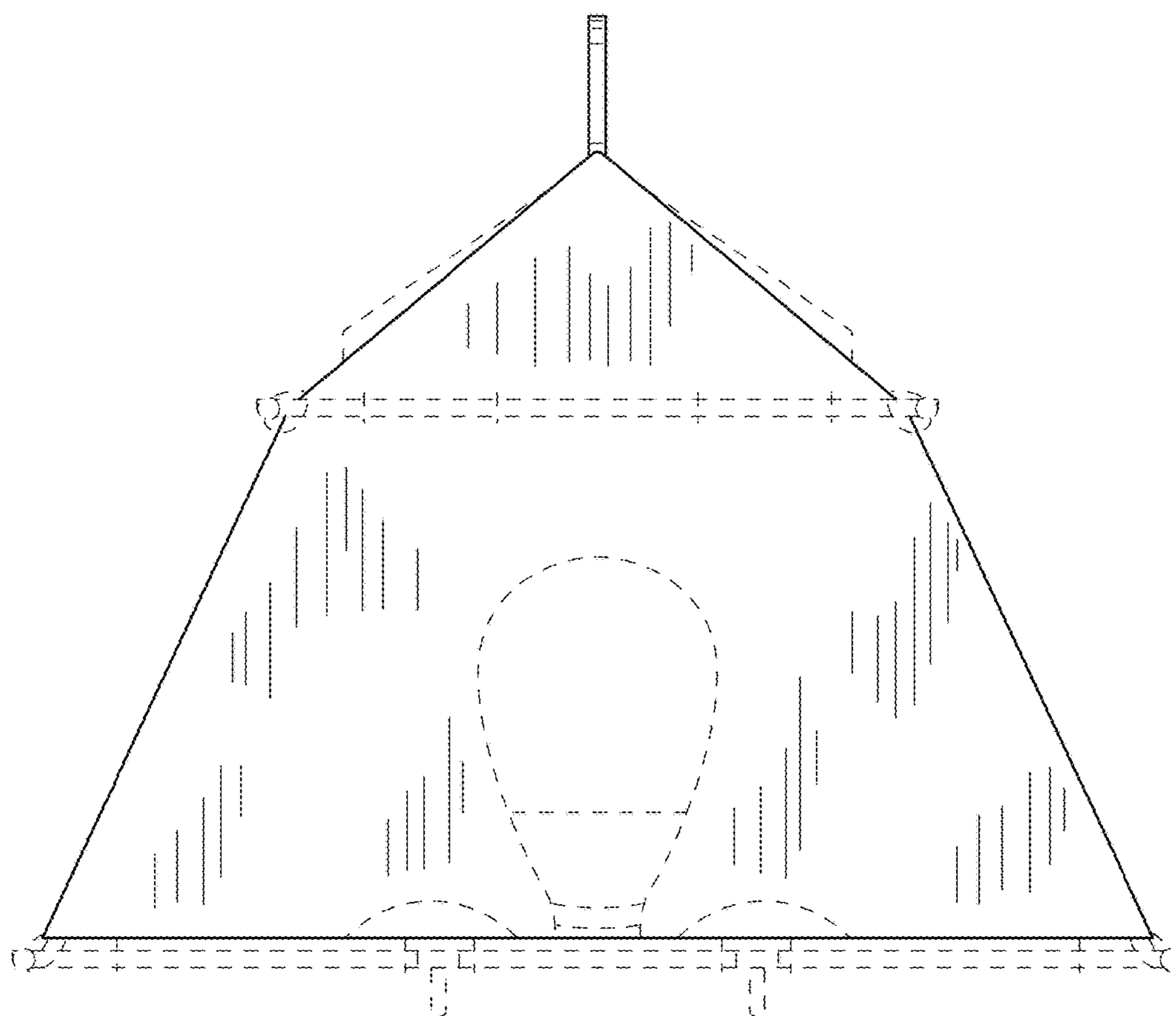

FIG.3

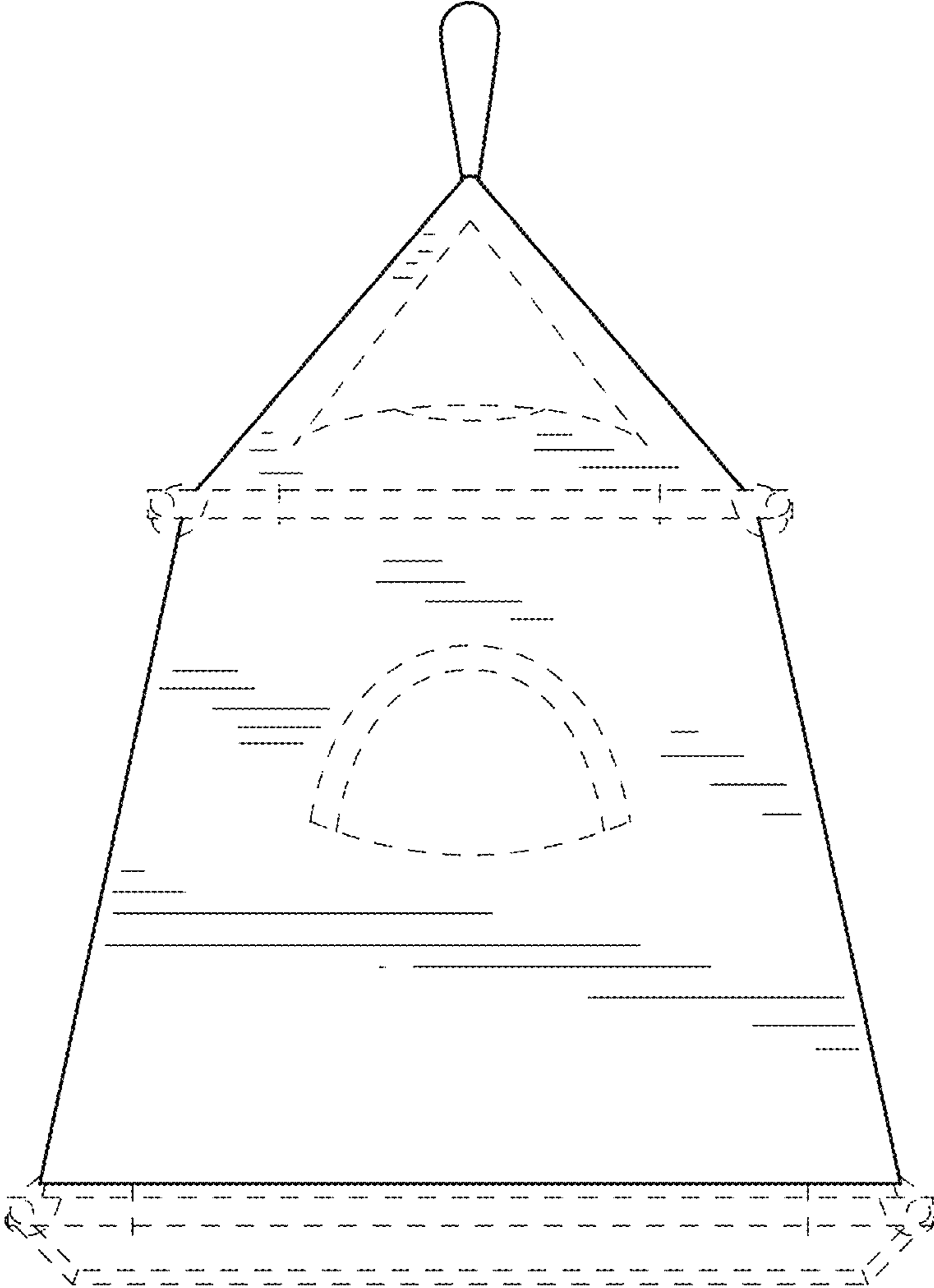

FIG.4

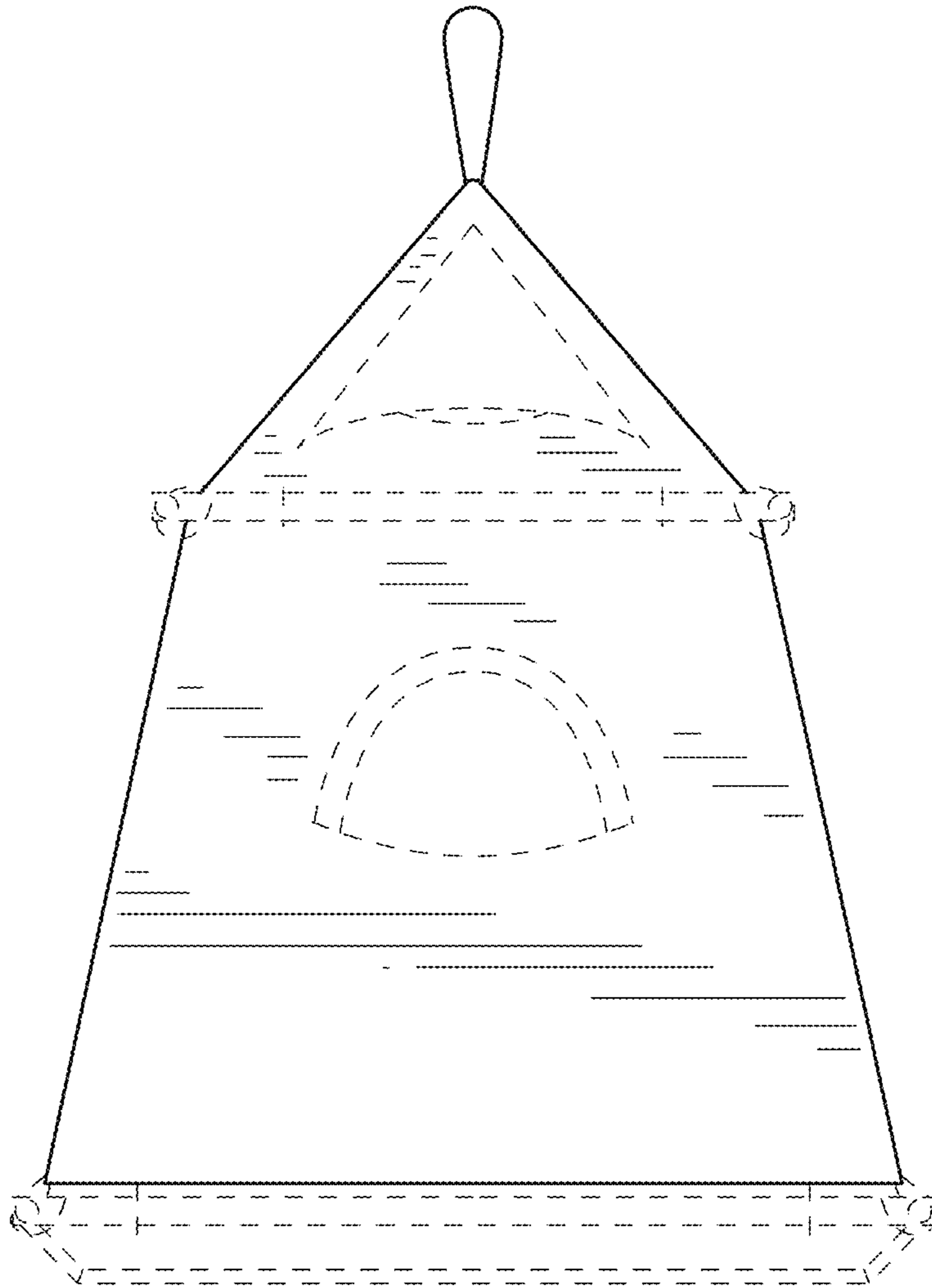

FIG.5

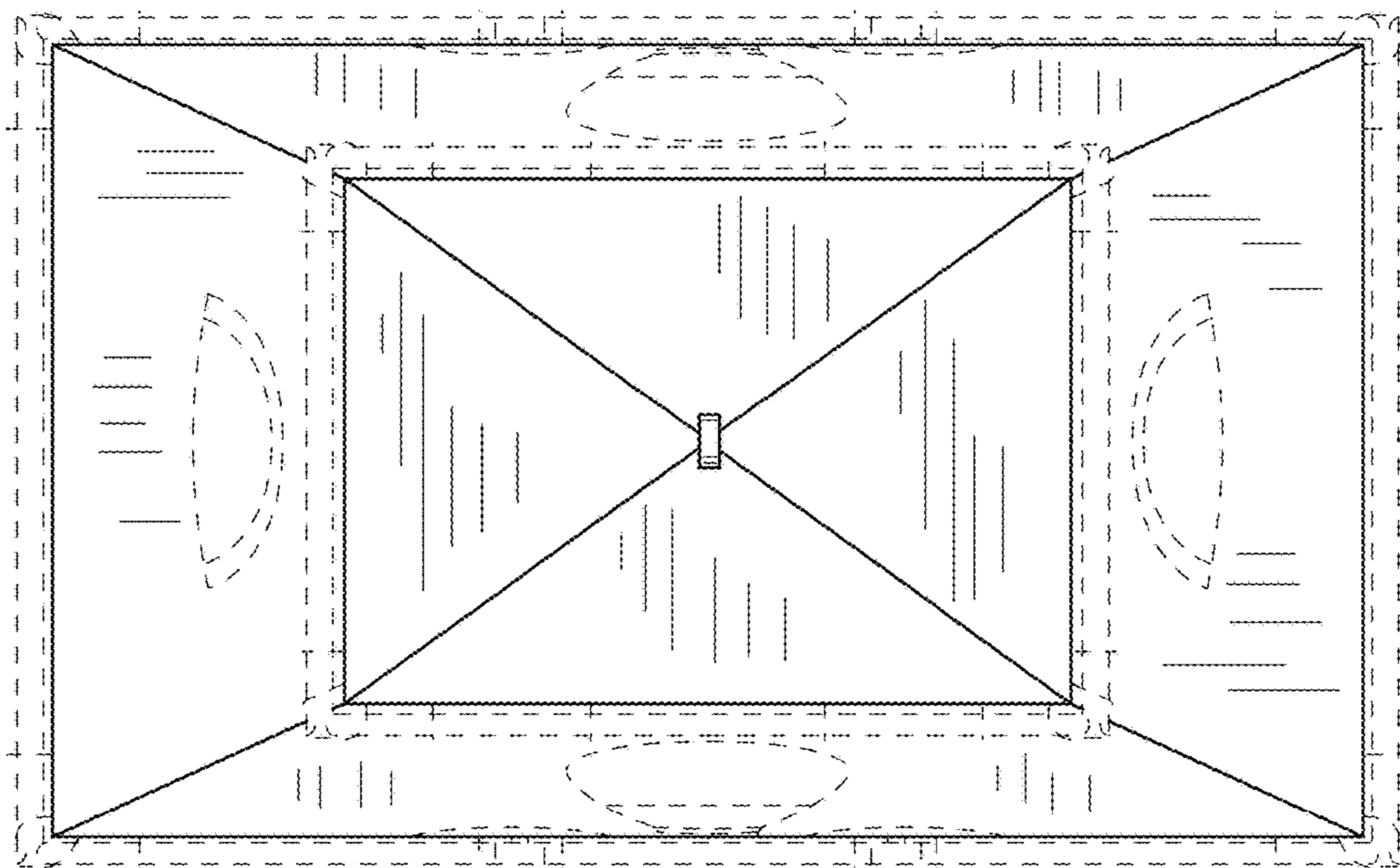

FIG.6

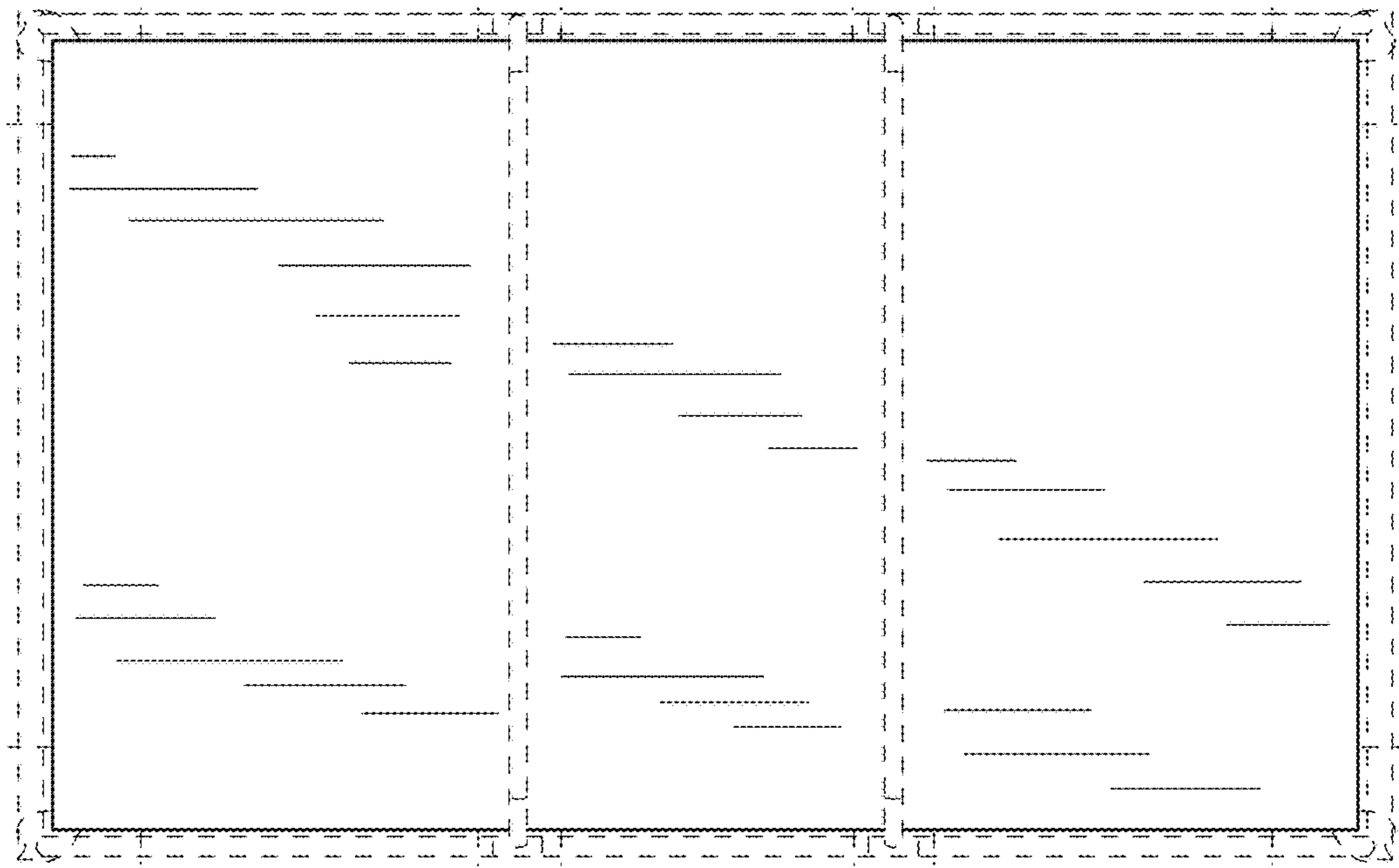

FIG.7