



US00D827030S

(12) **United States Design Patent**  
**Wear**

(10) **Patent No.:** **US D827,030 S**

(45) **Date of Patent:** **\*\* Aug. 28, 2018**

(54) **DISPLAY HANGER**

(71) Applicant: **Popco, Inc.**, Minnetonka, MN (US)

(72) Inventor: **Stuart Wear**, Minnetonka, MN (US)

(73) Assignee: **Popco, Inc.**, Minnetonka, MN (US)

(\*\*) Term: **15 Years**

(21) Appl. No.: **29/596,742**

(22) Filed: **Mar. 10, 2017**

(51) **LOC (11) Cl.** ..... **20-03**

(52) **U.S. Cl.**  
USPC ..... **D20/43**

(58) **Field of Classification Search**  
USPC ..... D6/300, 315, 512; D19/1-8; D20/10,  
D20/21-23, 25, 27, 29-33, 37, 40-44, 99

(Continued)

(56) **References Cited**

**U.S. PATENT DOCUMENTS**

4,623,169 A \* 11/1986 Hutten ..... B42D 5/005  
24/67.3  
4,899,974 A \* 2/1990 Wear ..... A47G 1/21  
211/45

(Continued)

**OTHER PUBLICATIONS**

Popco Inc., posted at Popco-usa.com, posted on Jun. 8, 2012, site visited Apr. 14, 2018. online, available from internet: <https://web.archive.org/web/20120608113208/http://www.popco-usa.com:80/t/categories/poster-hanging-and-mounting> (Year: 2012).\*

*Primary Examiner* — Mary Ann Calabrese

*Assistant Examiner* — Catherine Ho

(74) *Attorney, Agent, or Firm* — Patterson Thuent Pedersen, P.A.

(57) **CLAIM**

I claim the ornamental design for a display hanger, as shown and described.

**DESCRIPTION**

FIG. 1 is a perspective view of the first embodiment of a display hanger, showing my new design;

FIG. 2 is a front planar view depicting the display hanger of FIG. 1.

FIG. 3 is a back planar view depicting the display hanger of FIG. 1.

FIG. 4 is a top planar view depicting the display hanger of FIG. 1.

FIG. 5 is a bottom planar view depicting the display hanger of FIG. 1.

FIG. 6 is a right side planar view depicting the display hanger of FIG. 1.

FIG. 7 is a left side planar view depicting the display hanger of FIG. 1.

FIG. 8 is a perspective view of the second embodiment of a display hanger;

FIG. 9 is a front planar view depicting the display hanger of FIG. 8.

FIG. 10 is a top planar view depicting the display hanger of FIG. 8.

FIG. 11 is a bottom planar view depicting the display hanger of FIG. 8.

FIG. 12 is a side planar view depicting the display hanger of FIG. 8.

FIG. 13 is a perspective view of the third embodiment of a display hanger;

FIG. 14 is a front planar view depicting the display hanger of FIG. 13.

FIG. 15 is a back planar view depicting the display hanger of FIG. 13.

FIG. 16 is a top planar view depicting the display hanger of FIG. 13.

FIG. 17 is a bottom planar view depicting the display hanger of FIG. 13.

FIG. 18 is a right side planar view depicting the display hanger of FIG. 13.

FIG. 19 is a left side planar view depicting the display hanger of FIG. 13.

FIG. 20 is a perspective view of the fourth embodiment of a display hanger;

FIG. 21 is a front planar view depicting the display hanger of FIG. 20.

(Continued)

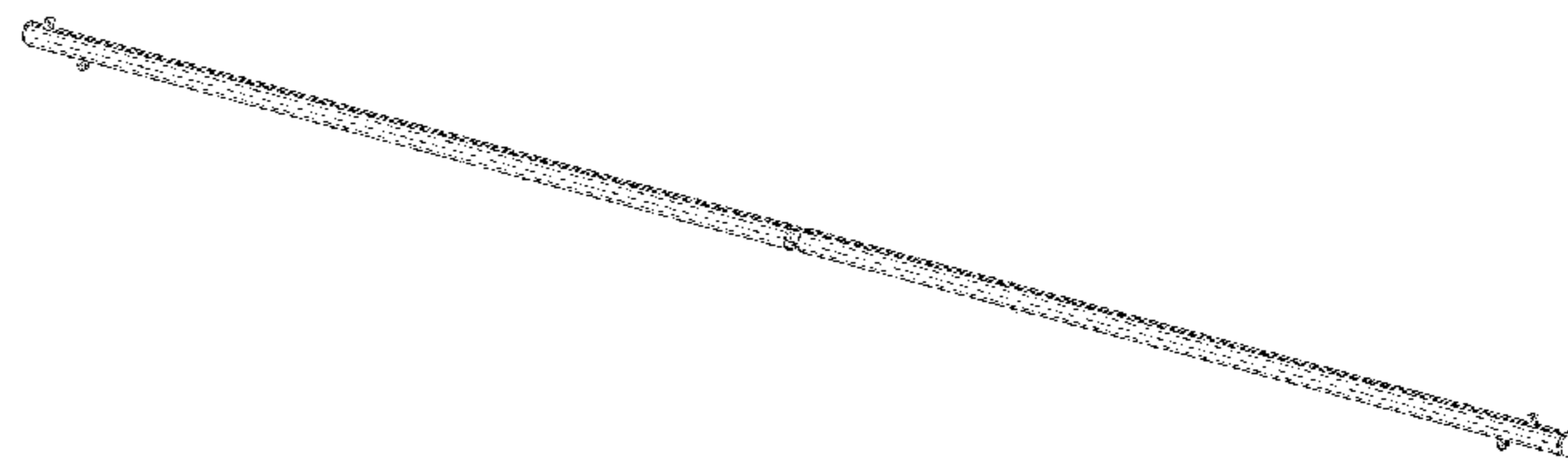
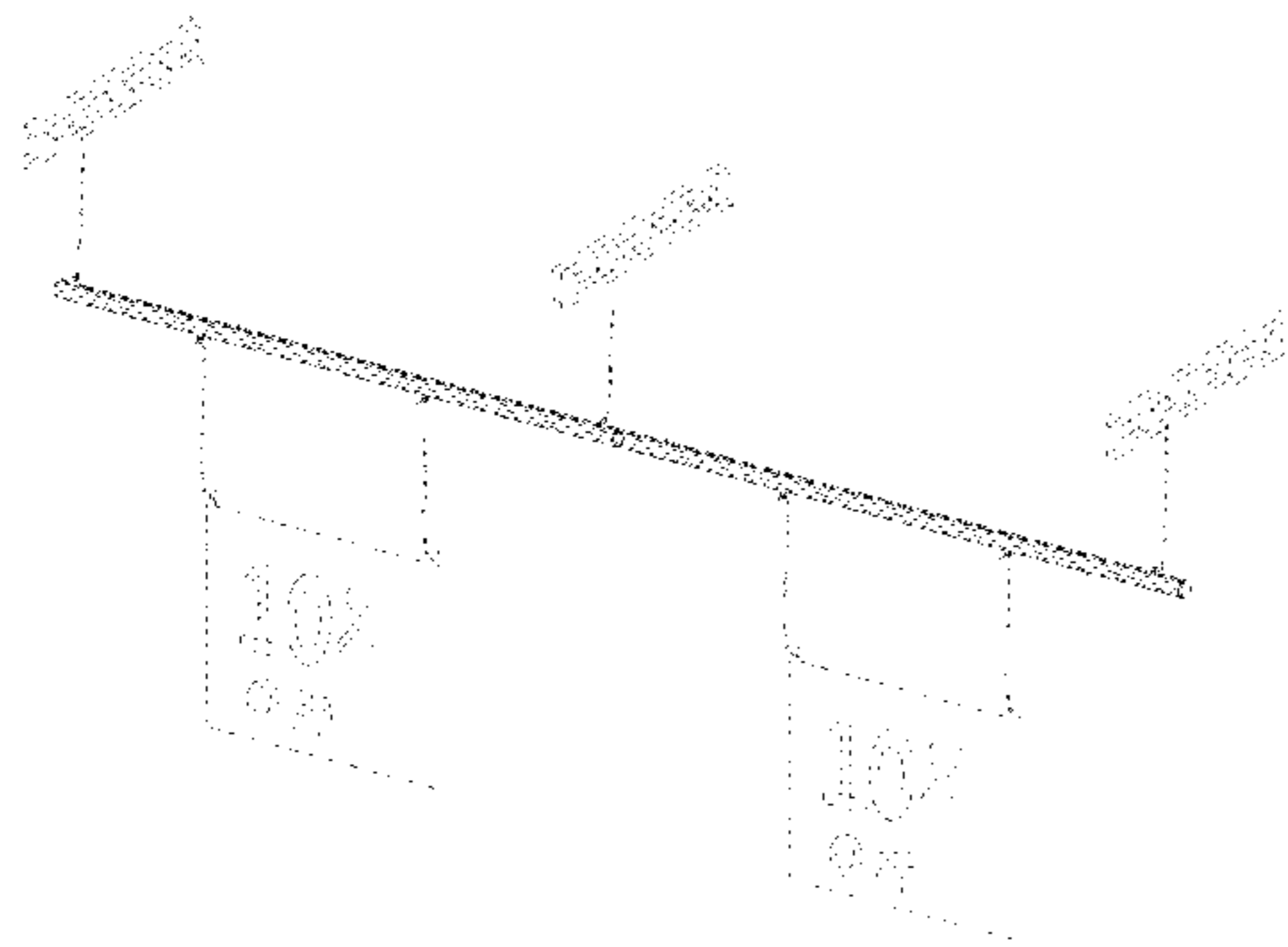

FIG. 22 is a top planar view depicting the display hanger of FIG. 20.

FIG. 23 is a bottom planar view depicting the display hanger of FIG. 20; and,

FIG. 24 is a side planar view depicting the display hanger of FIG. 20.

The broken line portion of the figure drawings is included to show environment that forms no part of the claimed design.

**1 Claim, 12 Drawing Sheets**

(58) **Field of Classification Search**

CPC ..... A63H 3/14; A63H 33/00; A63H 17/38;  
G09F 3/204; G09F 3/00; G09F 3/08;  
G09F 3/18; G09F 3/20; G09F 3/185;  
G09F 21/00; G09F 21/02

See application file for complete search history.

(56)

**References Cited**

U.S. PATENT DOCUMENTS

5,090,145	A *	2/1992	Chiang .....	A47G 1/065 40/605
D355,788	S *	2/1995	Irvin .....	D8/373
5,718,402	A *	2/1998	Hoffman .....	G09F 7/10 248/205.3
D424,120	S *	5/2000	Wear .....	D20/43
6,158,597	A *	12/2000	McDermott .....	B42D 5/04 211/45
D454,373	S *	3/2002	Kosir .....	D20/44
6,823,620	B2 *	11/2004	Nagel .....	G09F 3/204 40/5
D520,862	S *	5/2006	Munson .....	D8/354
D680,754	S *	4/2013	Wear .....	D6/300
2002/0125397	A1 *	9/2002	Wear .....	A47G 1/0611 248/473
2006/0236576	A1 *	10/2006	Wear .....	A47G 1/0611 40/607.14

\* cited by examiner

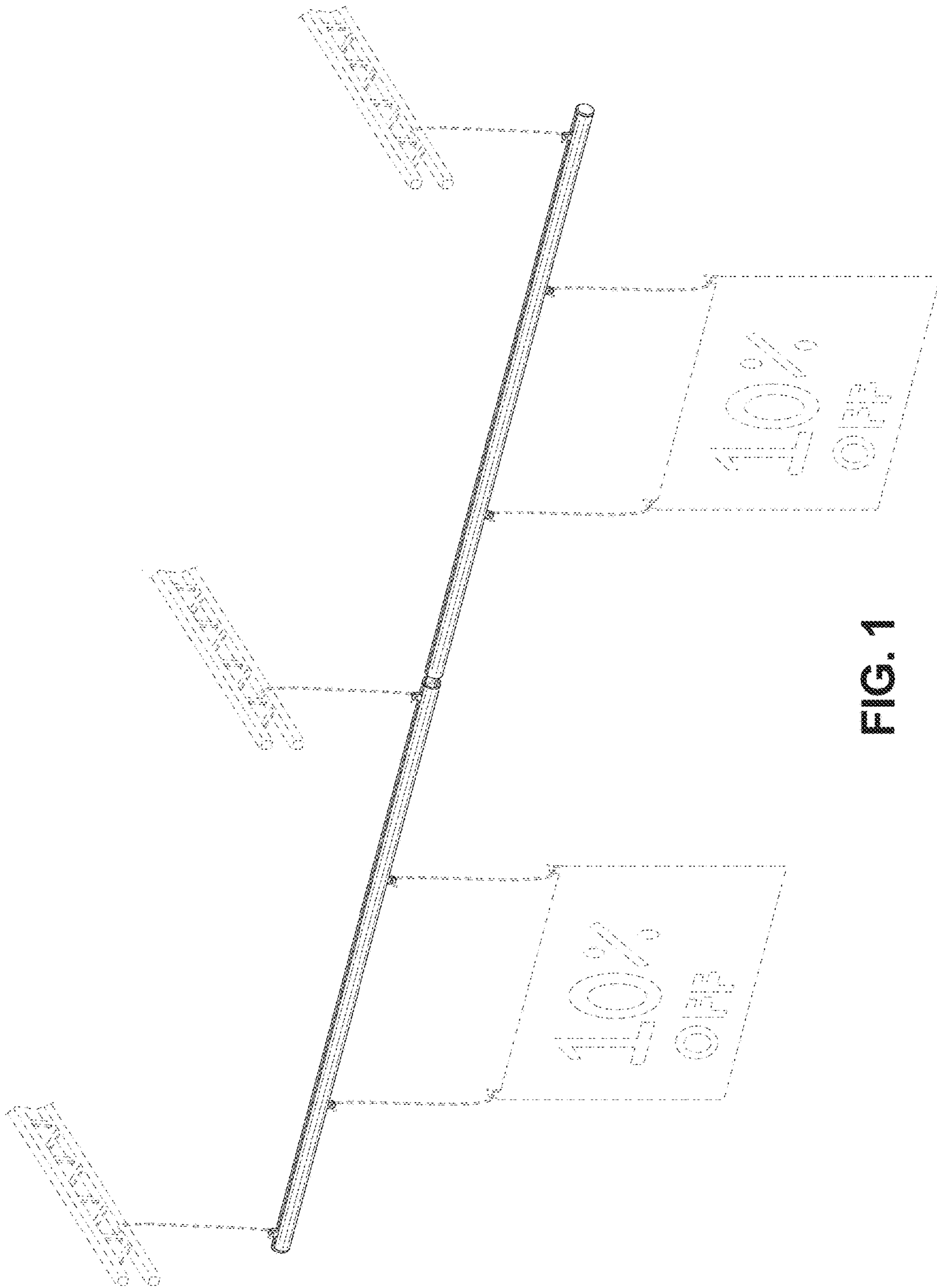

FIG. 1

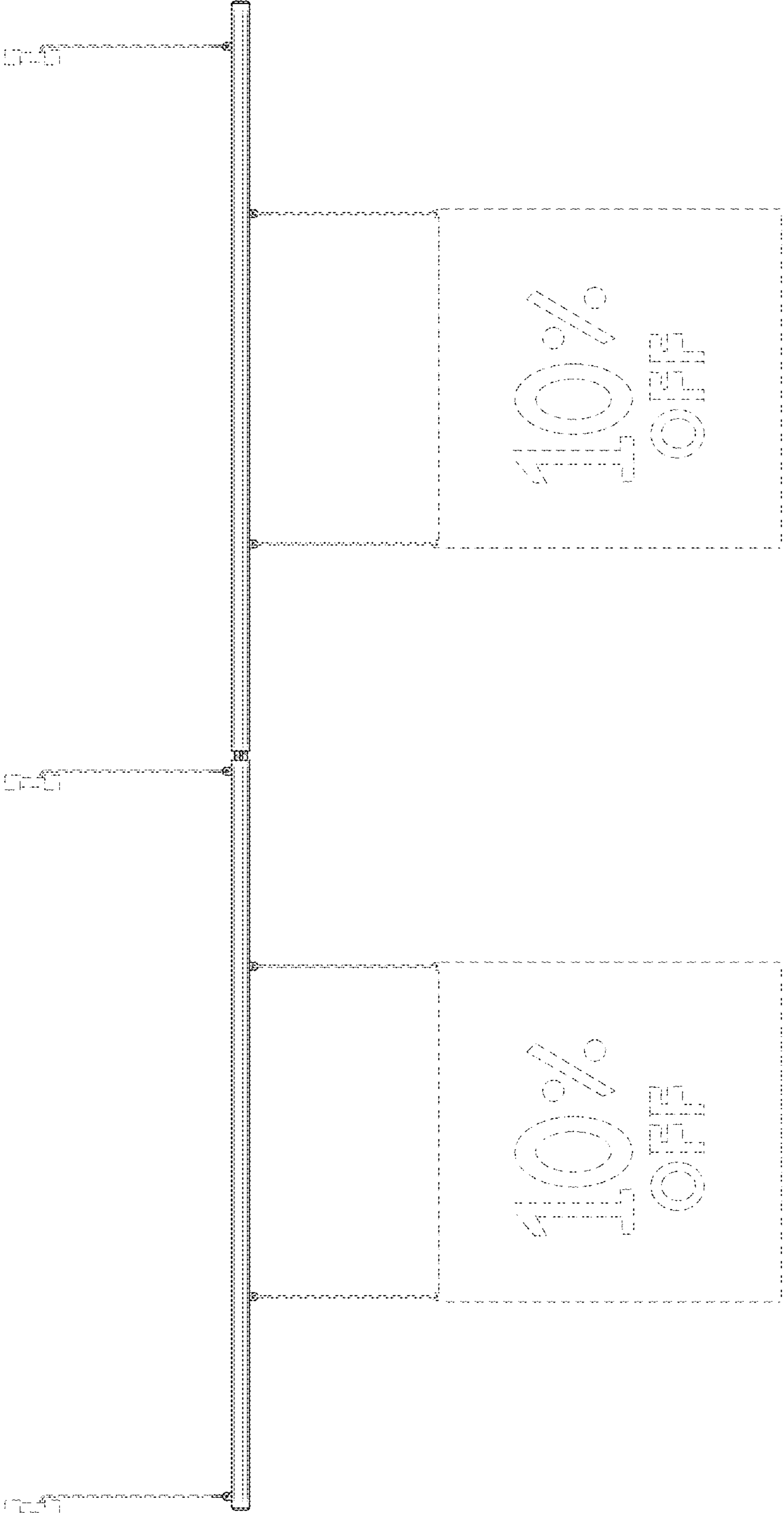
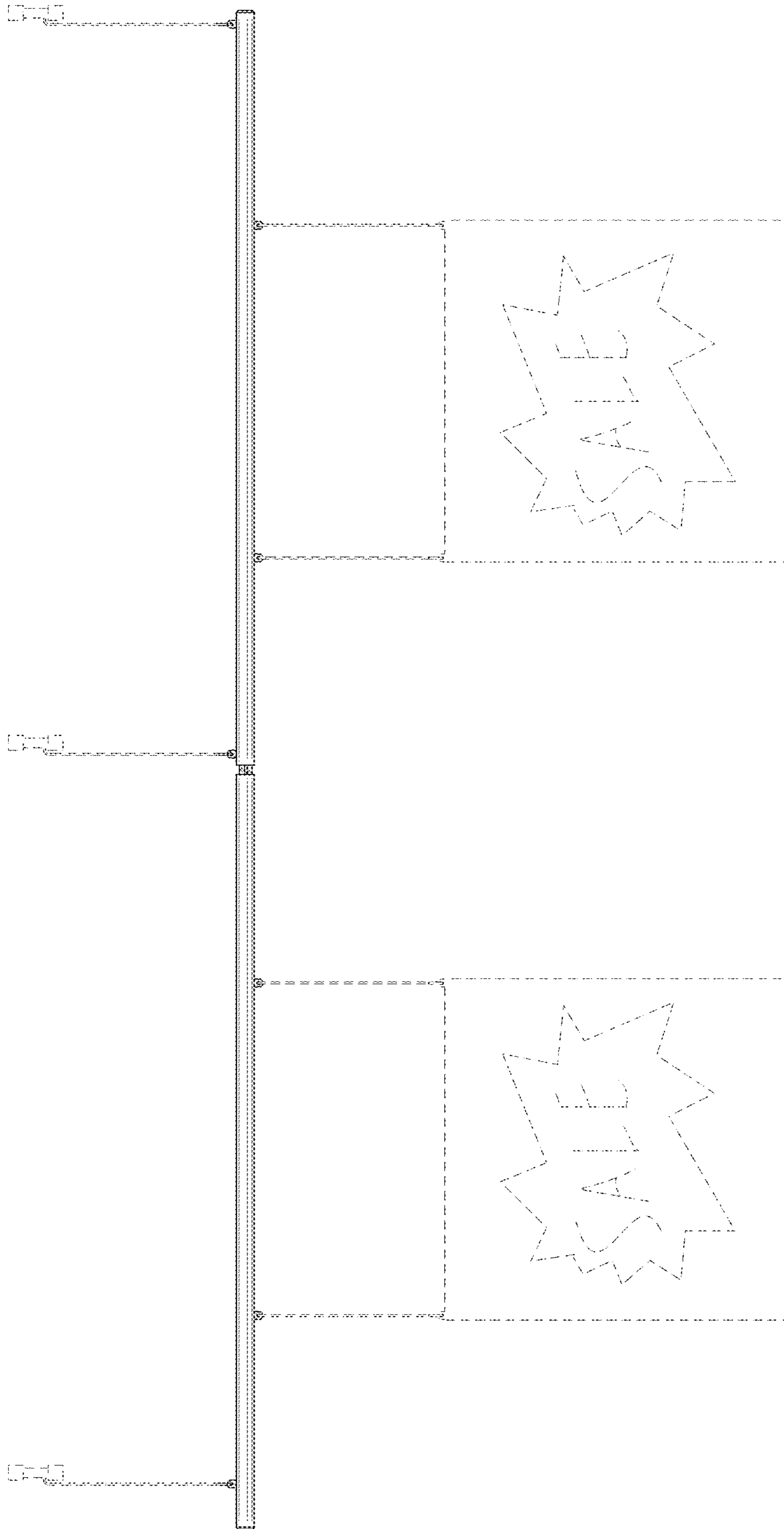
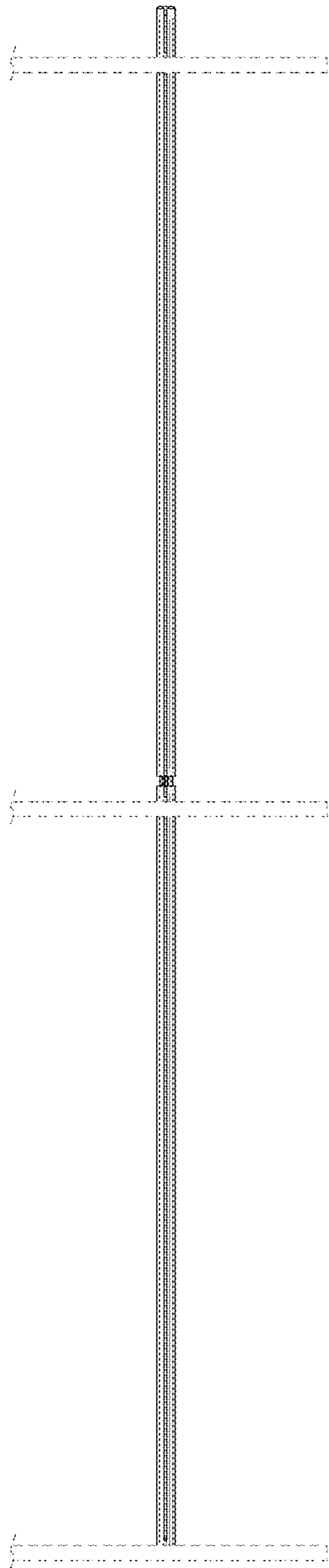

FIG. 2



**FIG. 3**



**FIG. 4**

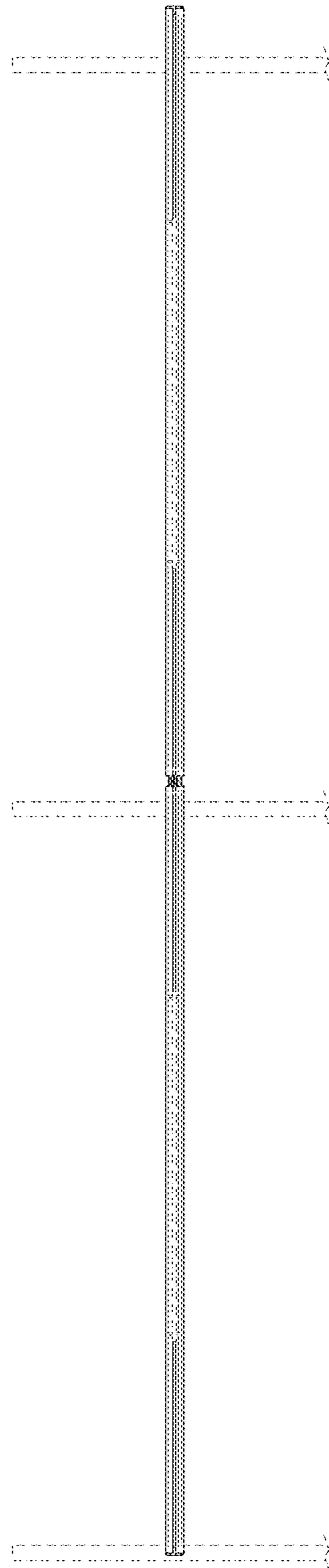

**FIG. 5**

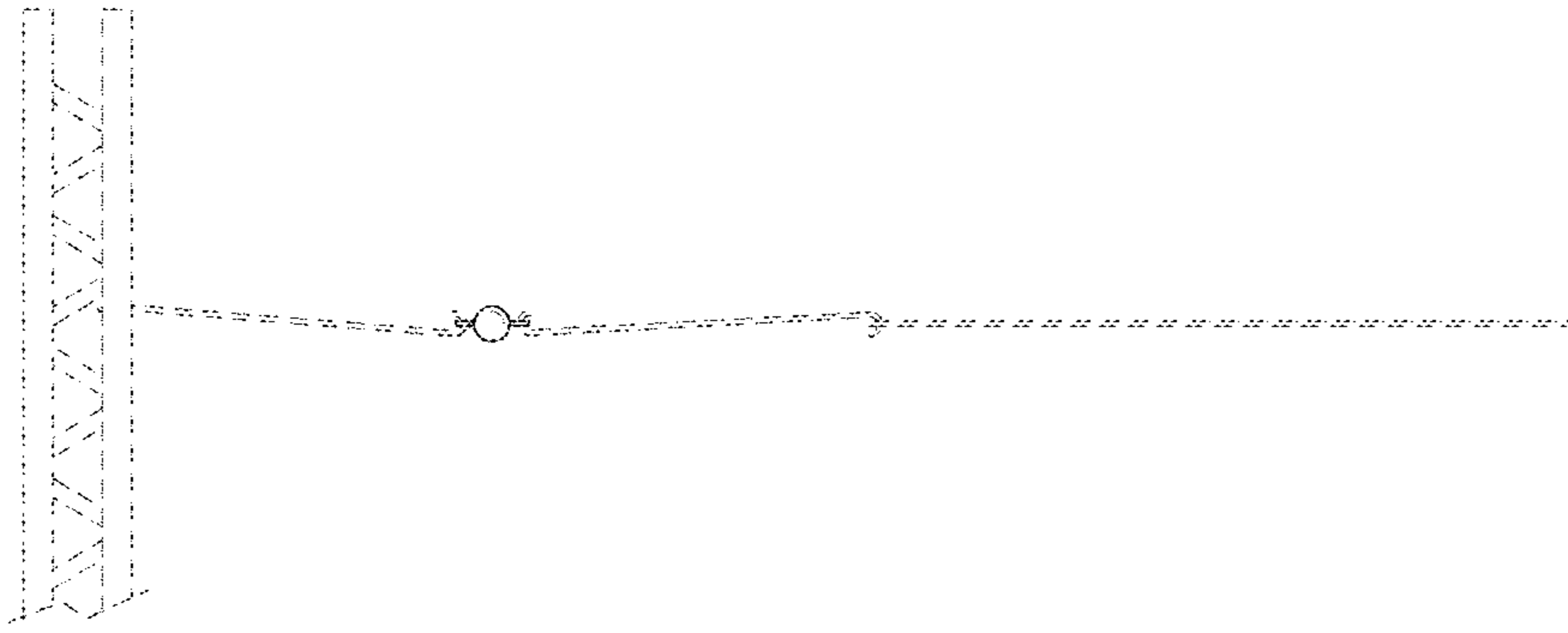

FIG. 6

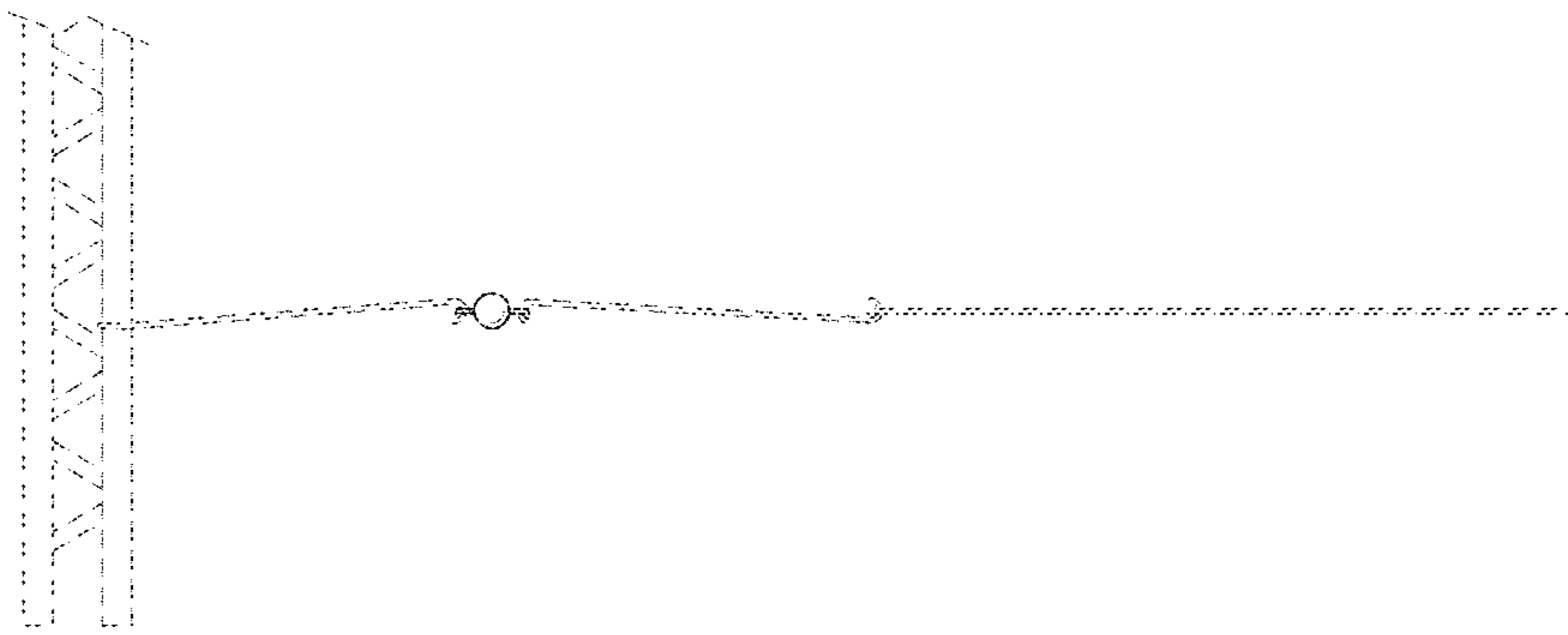

FIG. 7

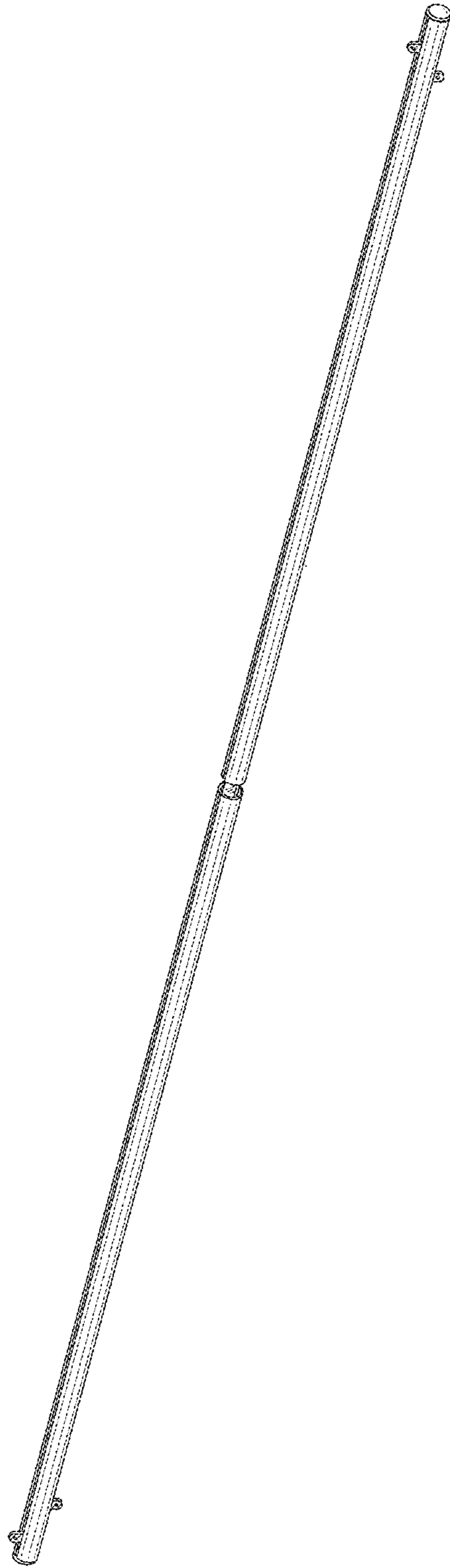

FIG. 8





**FIG. 9**



**FIG. 10**



**FIG. 11**



**FIG. 12**

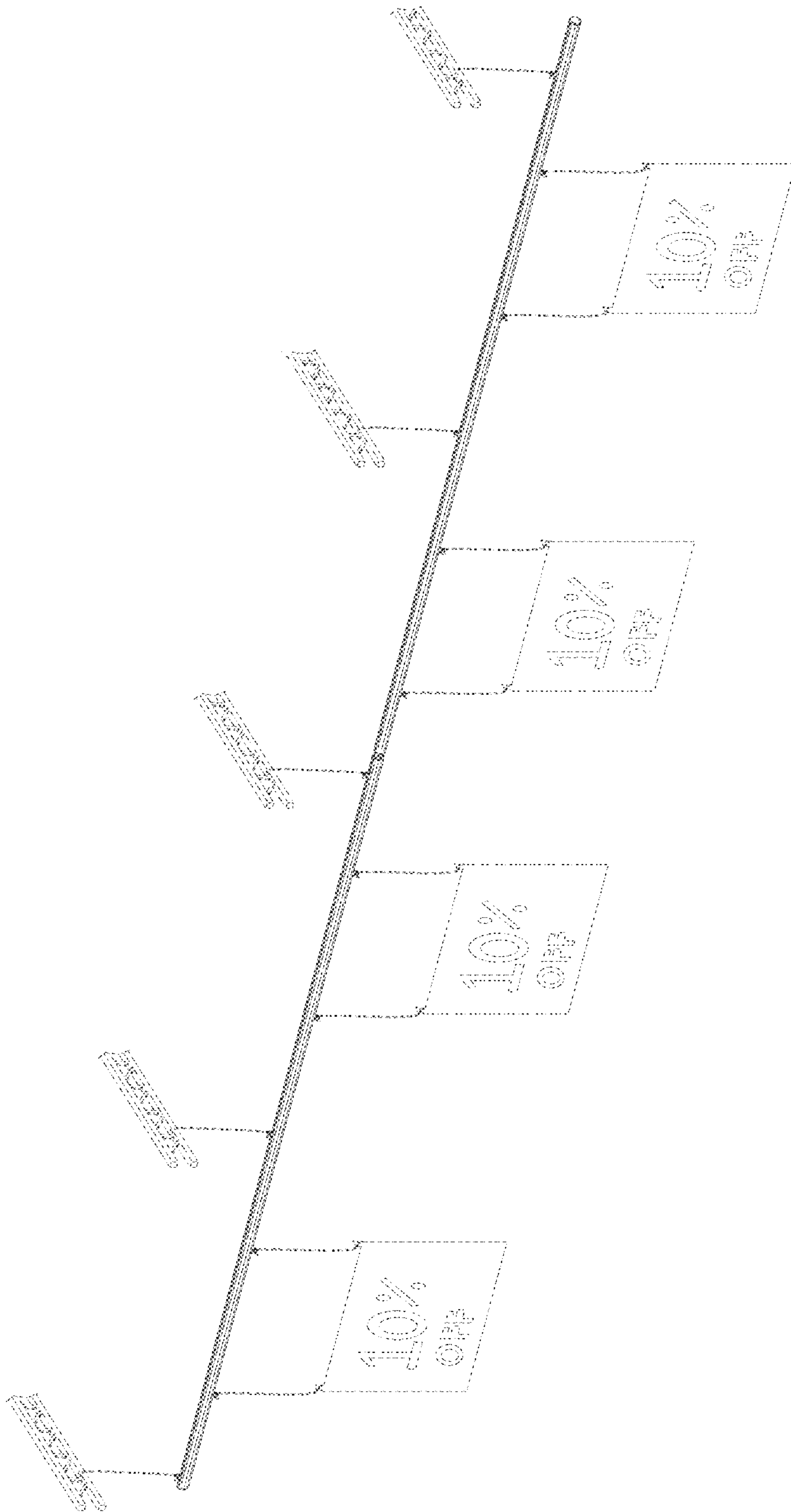

FIG. 13

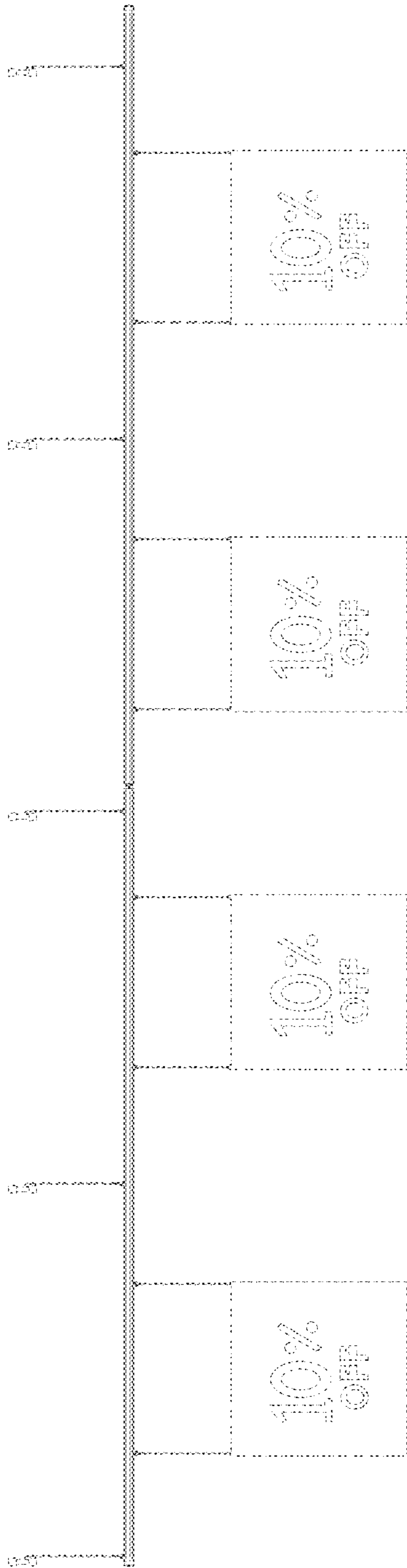

FIG. 14

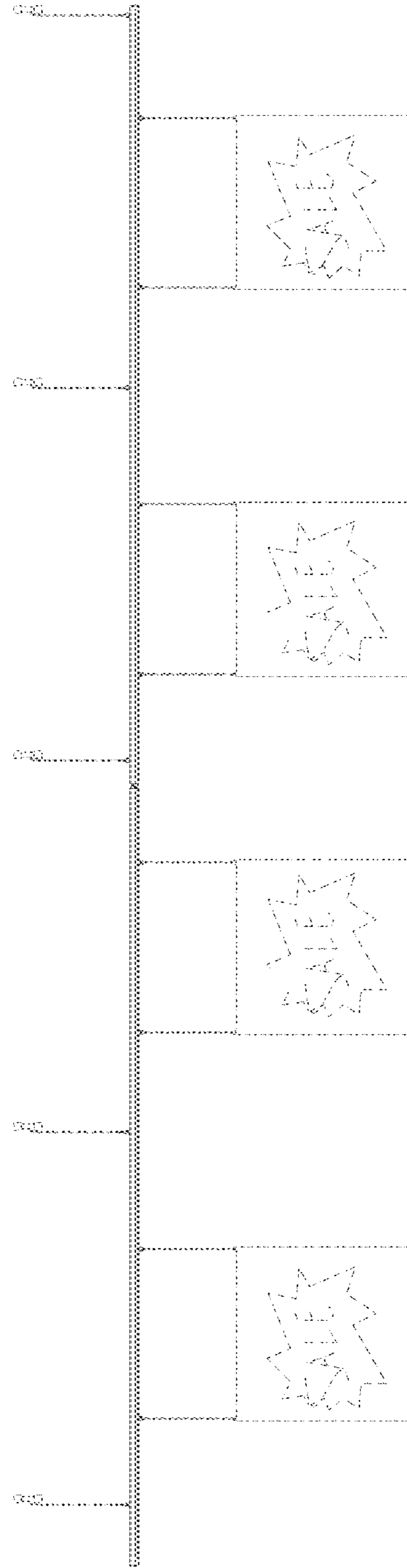

FIG. 15

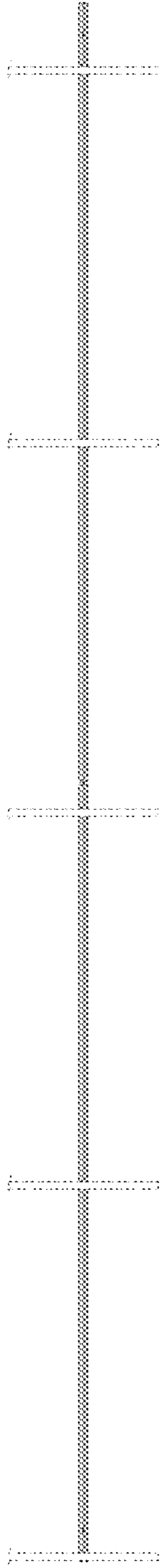

FIG. 16

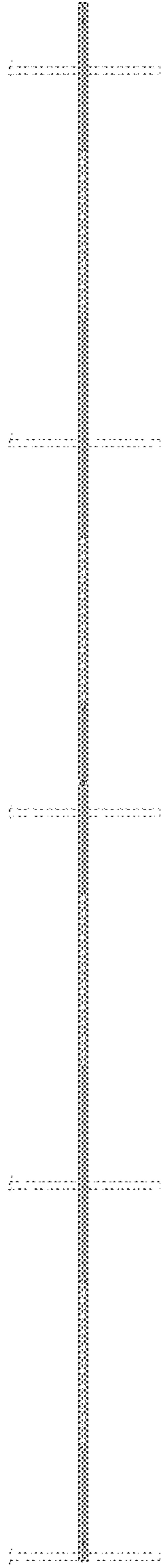

FIG. 17

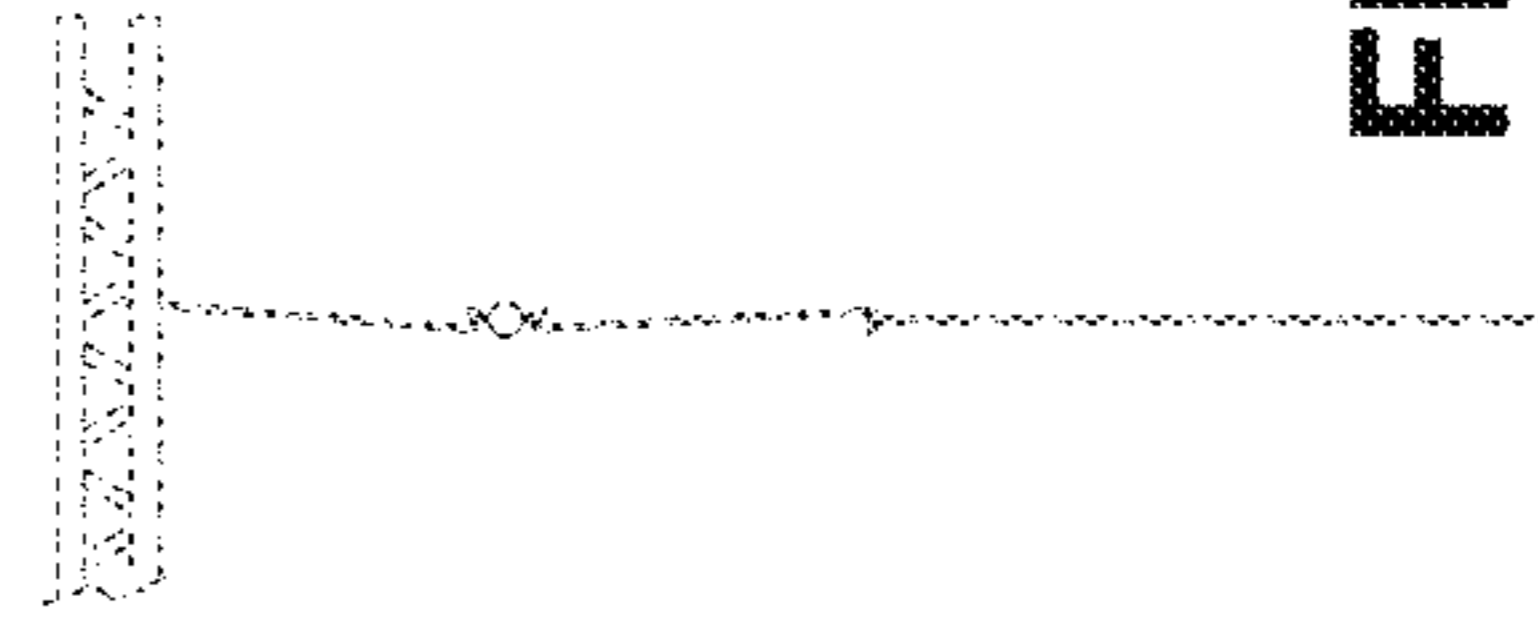

FIG. 19

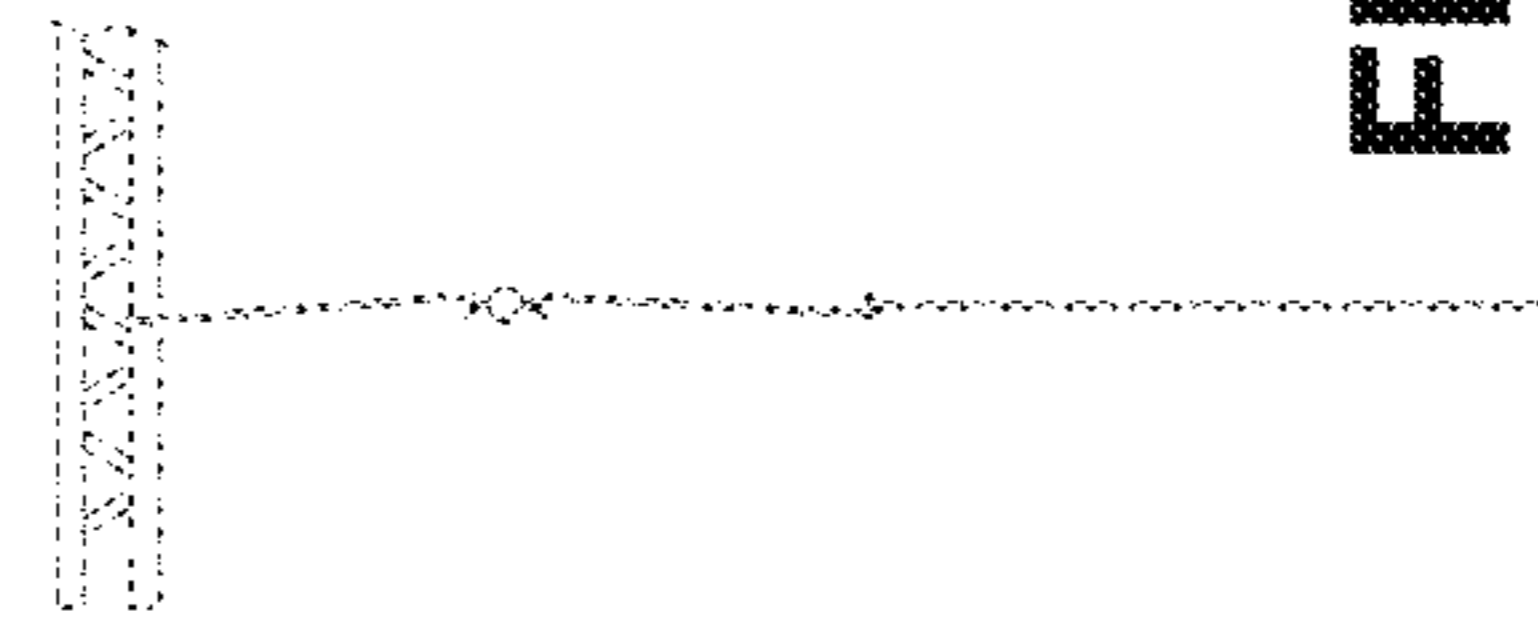
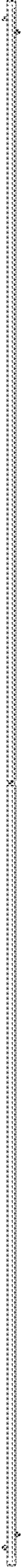

FIG. 18



FIG. 20



**FIG. 21**



**FIG. 22**



**FIG. 23**



**FIG. 24**