



US00D827002S

(12) **United States Design Patent**  
**Nelson**

(10) **Patent No.:** **US D827,002 S**

(45) **Date of Patent:** **\*\* Aug. 28, 2018**

(54) **WRAPPING APPARATUS**

(71) Applicant: **Encore Packaging LLC**, Lake Bluff, IL (US)

(72) Inventor: **Timothy H. Nelson**, Winnetka, IL (US)

(73) Assignee: **Encore Packaging LLC**, Lake Bluff, IL (US)

(\*\*) Term: **15 Years**

(21) Appl. No.: **29/596,035**

(22) Filed: **Mar. 3, 2017**

(51) **LOC (11) Cl.** ..... **15-99**

(52) **U.S. Cl.**  
USPC ..... **D15/145**

(58) **Field of Classification Search**  
USPC ..... D15/122, 138, 145  
CPC ..... A01F 2015/074; A01F 2015/076; A01F 2015/077; A01F 2015/0715; B65B 11/04; B65B 57/18

See application file for complete search history.

4,166,348 A \* 9/1979 Carlson ..... B65B 11/04 53/210

4,205,501 A \* 6/1980 Michels ..... B65B 11/12 53/228

4,317,322 A \* 3/1982 Lancaster ..... B65B 11/008 53/399

4,369,614 A \* 1/1983 Tetzner ..... B65B 67/085 242/557

4,418,510 A \* 12/1983 Lancaster, III ..... B65B 11/04 53/399

4,517,890 A \* 5/1985 Campbell ..... A01F 15/141 100/5

4,546,598 A \* 10/1985 Karpisek ..... B65B 9/135 53/390

4,620,408 A \* 11/1986 Parnes ..... B65B 11/025 53/556

(Continued)

*Primary Examiner* — Patricia A Palasik  
(74) *Attorney, Agent, or Firm* — Fitch, Even Tabin and Flannery LLP

(57) **CLAIM**

We claim the ornamental design for a wrapping apparatus, as shown and described.

**DESCRIPTION**

FIG. 1 is a front perspective view of a wrapping apparatus in accordance with our new design.

FIG. 2 is a front elevation thereof.

FIG. 3 is a left side elevation thereof.

FIG. 4 is a rear elevation thereof.

FIG. 5 is a top plan view thereof.

FIG. 6 is a bottom plan view thereof; and,

FIG. 7 is a perspective view of FIGS. 1-6 with an unclaimed box added to illustrate environmental subject matter.

Any portions of the wrapping apparatus shown in broken lines in the figures depict unclaimed environmental subject matter and form no part of the claimed design.

**1 Claim, 6 Drawing Sheets**

(56) **References Cited**

U.S. PATENT DOCUMENTS

2,642,708 A \* 6/1953 Hess ..... B65B 11/56 53/216

3,217,858 A \* 11/1965 Fellner ..... B65B 35/20 198/468.1

3,224,161 A \* 12/1965 Conti ..... B65B 11/12 493/133

3,705,476 A \* 12/1972 Wolf ..... B65B 11/42 53/210

3,738,079 A \* 6/1973 Rudman ..... B65B 9/135 53/386.1

4,036,268 A \* 7/1977 Ward ..... B21F 15/00 140/124

4,077,179 A \* 3/1978 Lancaster ..... B65B 11/045 100/15

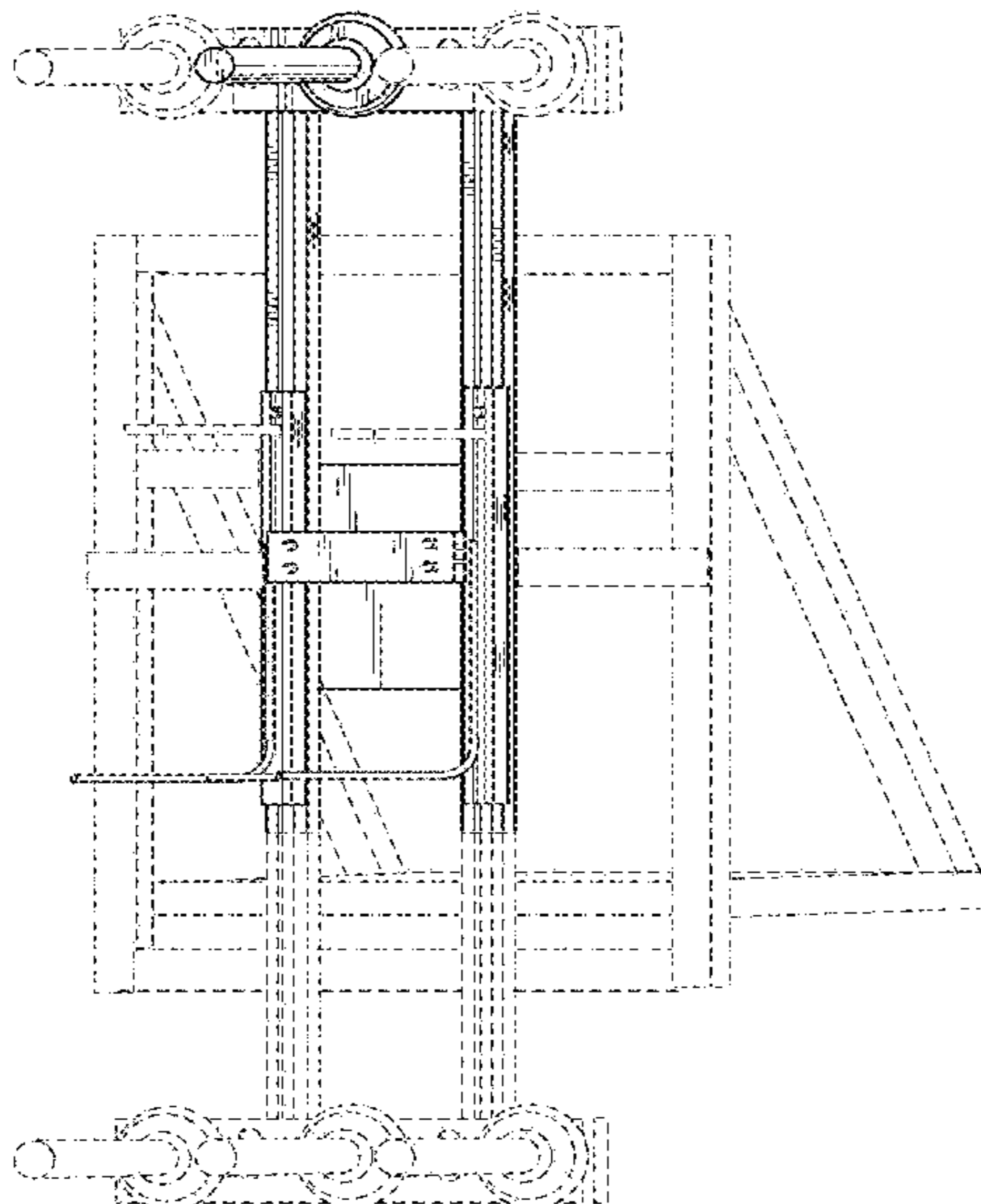

# US D827,002 S

Page 2

(56)

## References Cited

### U.S. PATENT DOCUMENTS

4,832,767	A *	5/1989	Eller	.....	H02G 15/196	156/212
5,301,493	A *	4/1994	Chen	.....	B65B 11/045	53/556
5,423,163	A *	6/1995	Wendt	.....	B65B 11/025	53/556
5,457,931	A *	10/1995	Kurata	.....	G07D 9/065	53/212
5,570,564	A *	11/1996	Moore	.....	B65B 11/045	242/571.4
5,934,049	A *	8/1999	Cerf	.....	B65B 35/16	53/553
6,237,307	B1 *	5/2001	Zentmyer	.....	B65B 67/085	53/390
7,178,317	B1 *	2/2007	Koskela	.....	B65B 11/045	242/597.8
7,210,649	B2 *	5/2007	Yu Chen	.....	B65D 85/02	242/405.3
7,552,891	B2 *	6/2009	Huang	.....	B65B 67/085	242/405.3
D696,323	S *	12/2013	Hannen	.....	D15/145	
D798,352	S *	9/2017	Si	.....	D15/145	
2006/0260279	A1 *	11/2006	Jafari	.....	B65B 11/025	53/399
2007/0204564	A1 *	9/2007	Lancaster, III	.....	B65B 11/006	53/399
2008/0168643	A1 *	7/2008	Albert	.....	B65B 11/04	29/402.08
2009/0235617	A1 *	9/2009	Moore	.....	B65B 11/006	53/461
2014/0298754	A1 *	10/2014	Van Wijngaarden ..	.....	B65G 47/18	53/443
2016/0137454	A1 *	5/2016	Stanton	.....	B65H 16/005	242/423.2
2017/0057673	A1 *	3/2017	Corberi	.....	B65B 11/025	

\* cited by examiner

FIG. 1

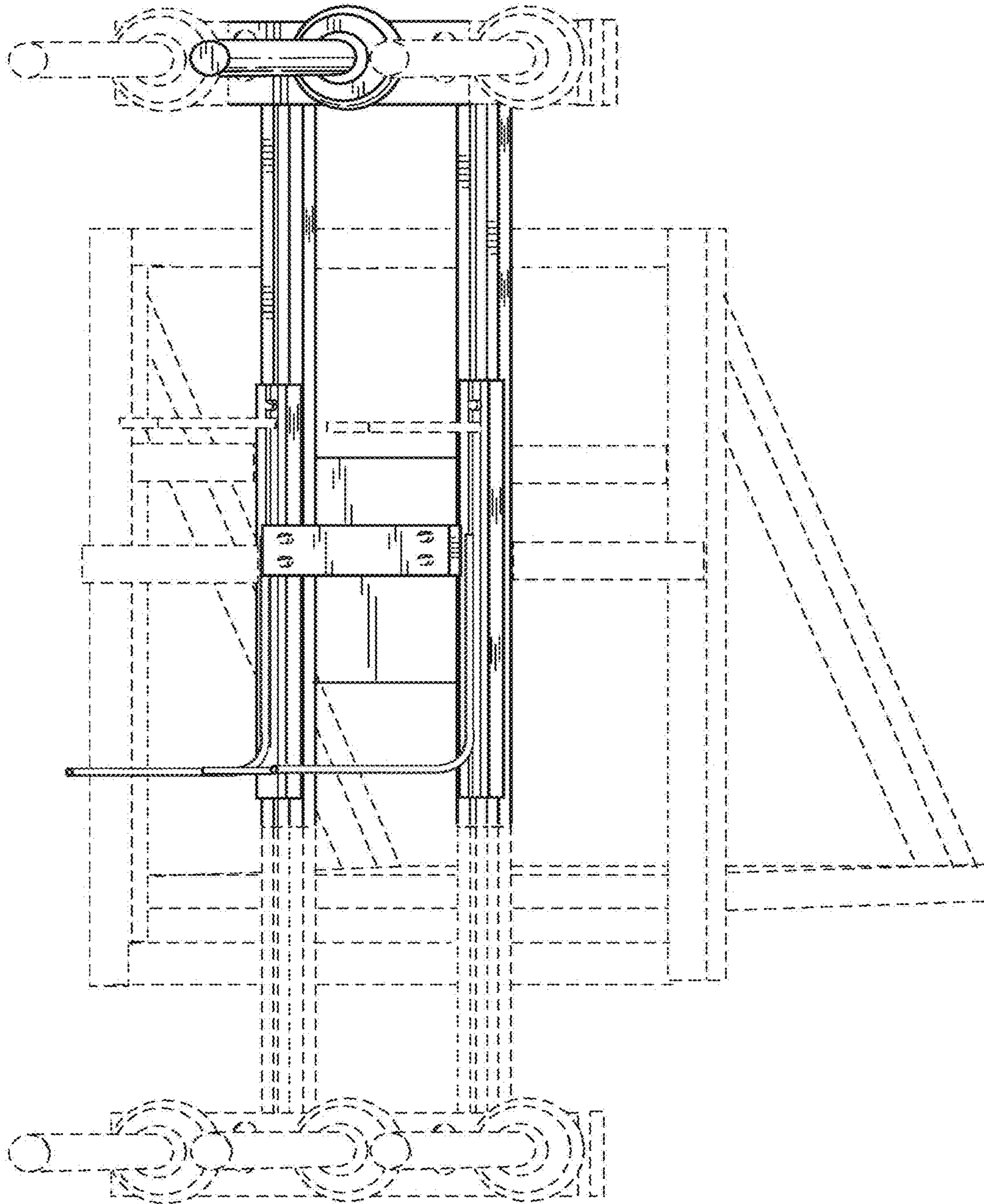

FIG. 2

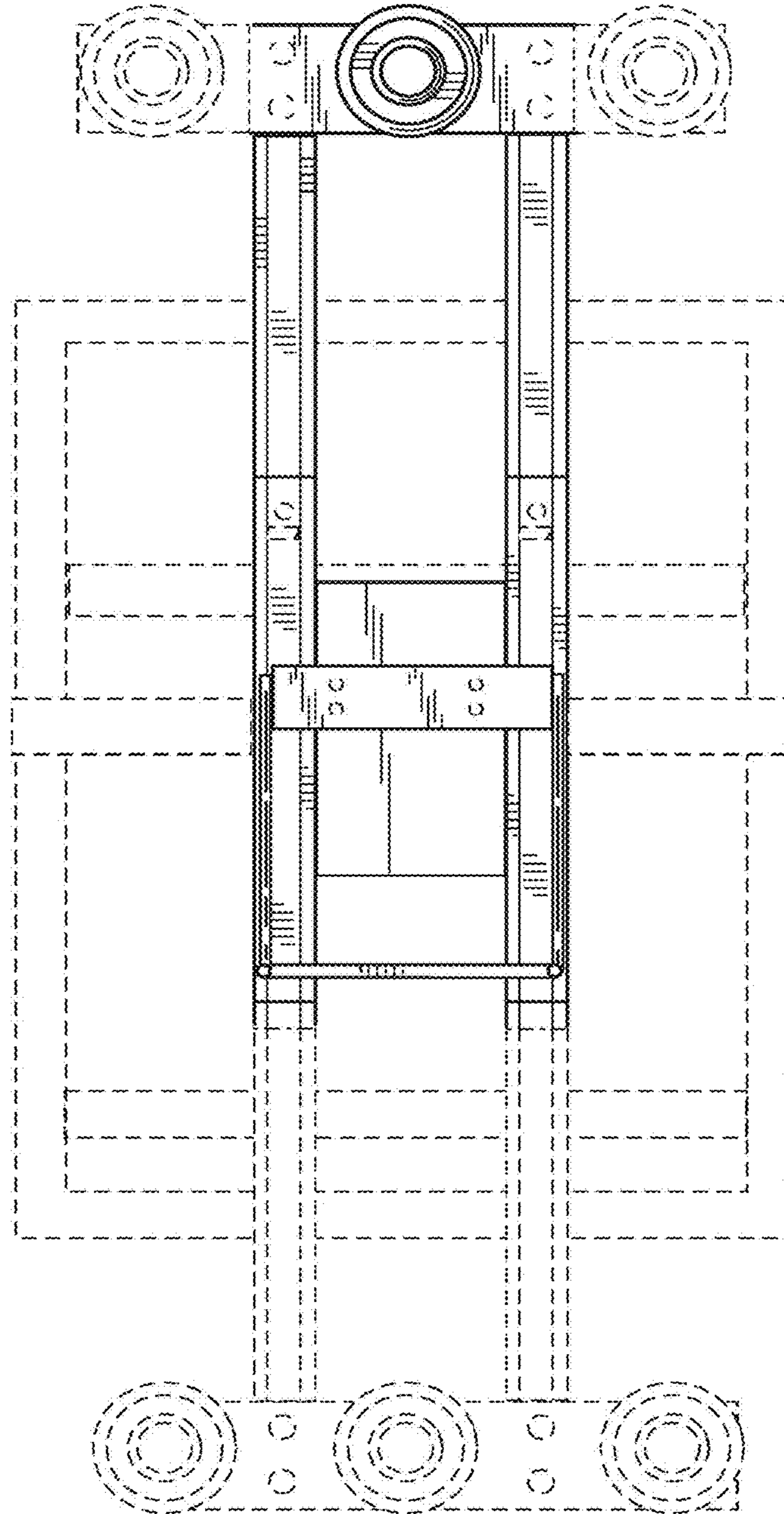

FIG. 3

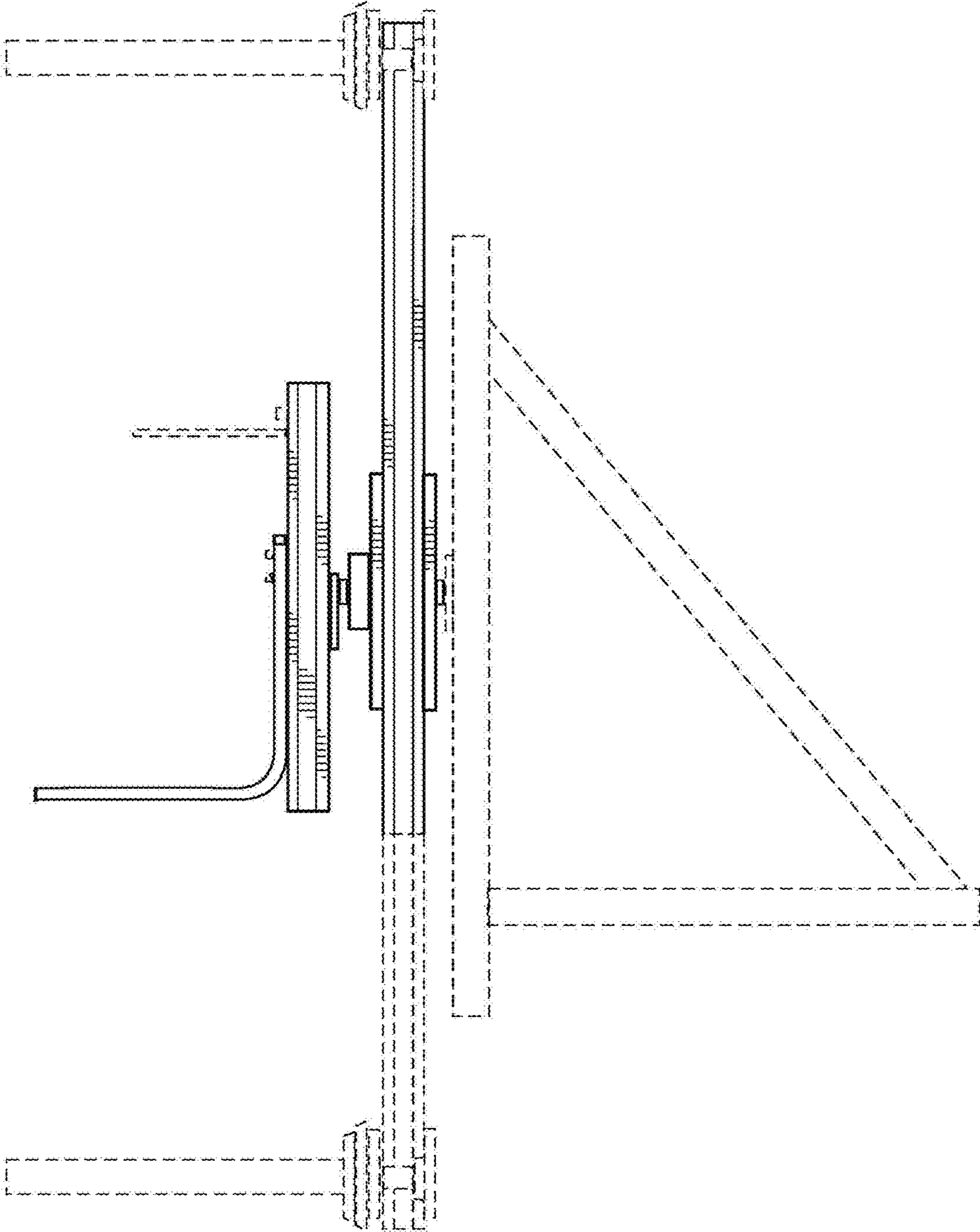

FIG. 4

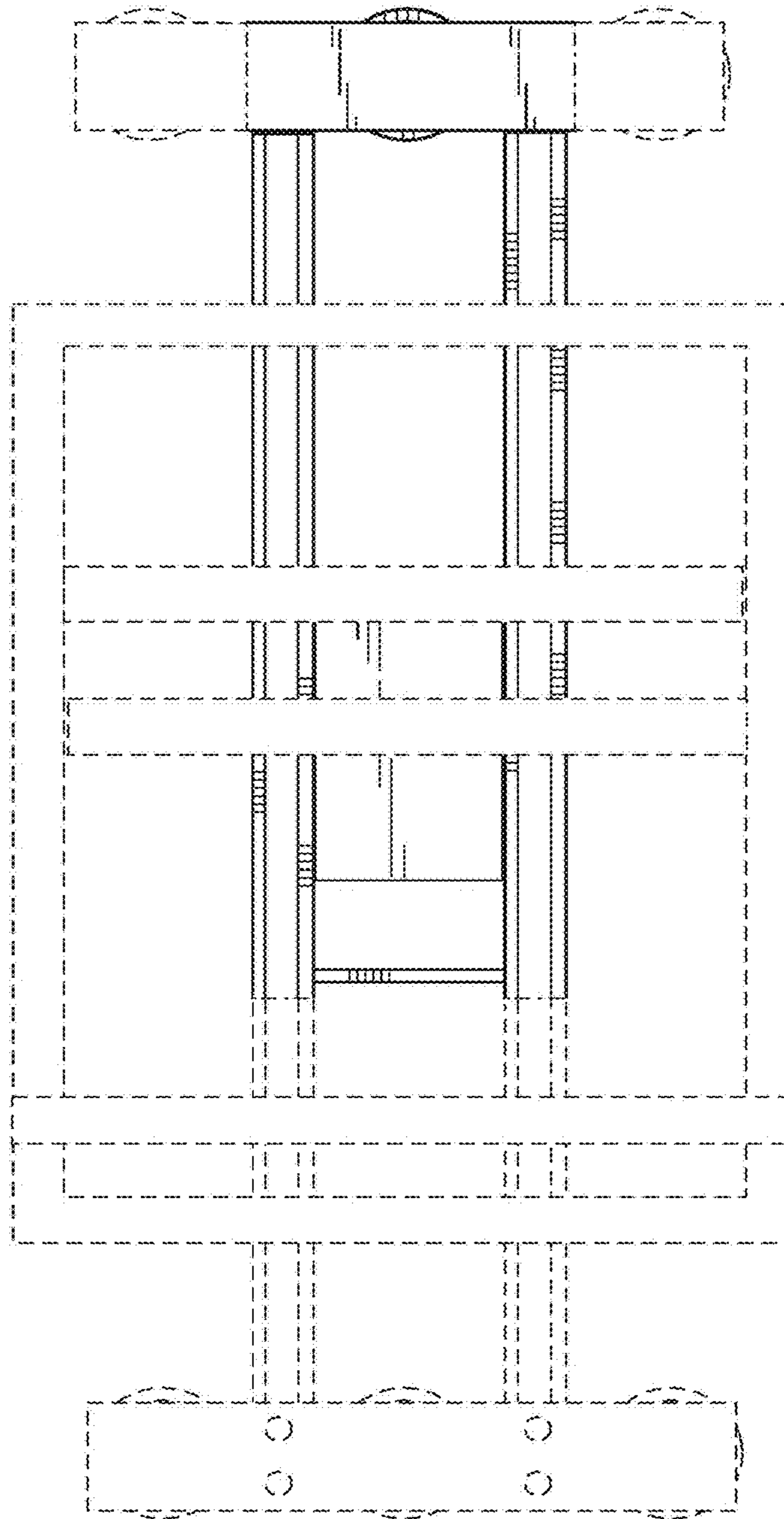

FIG. 5

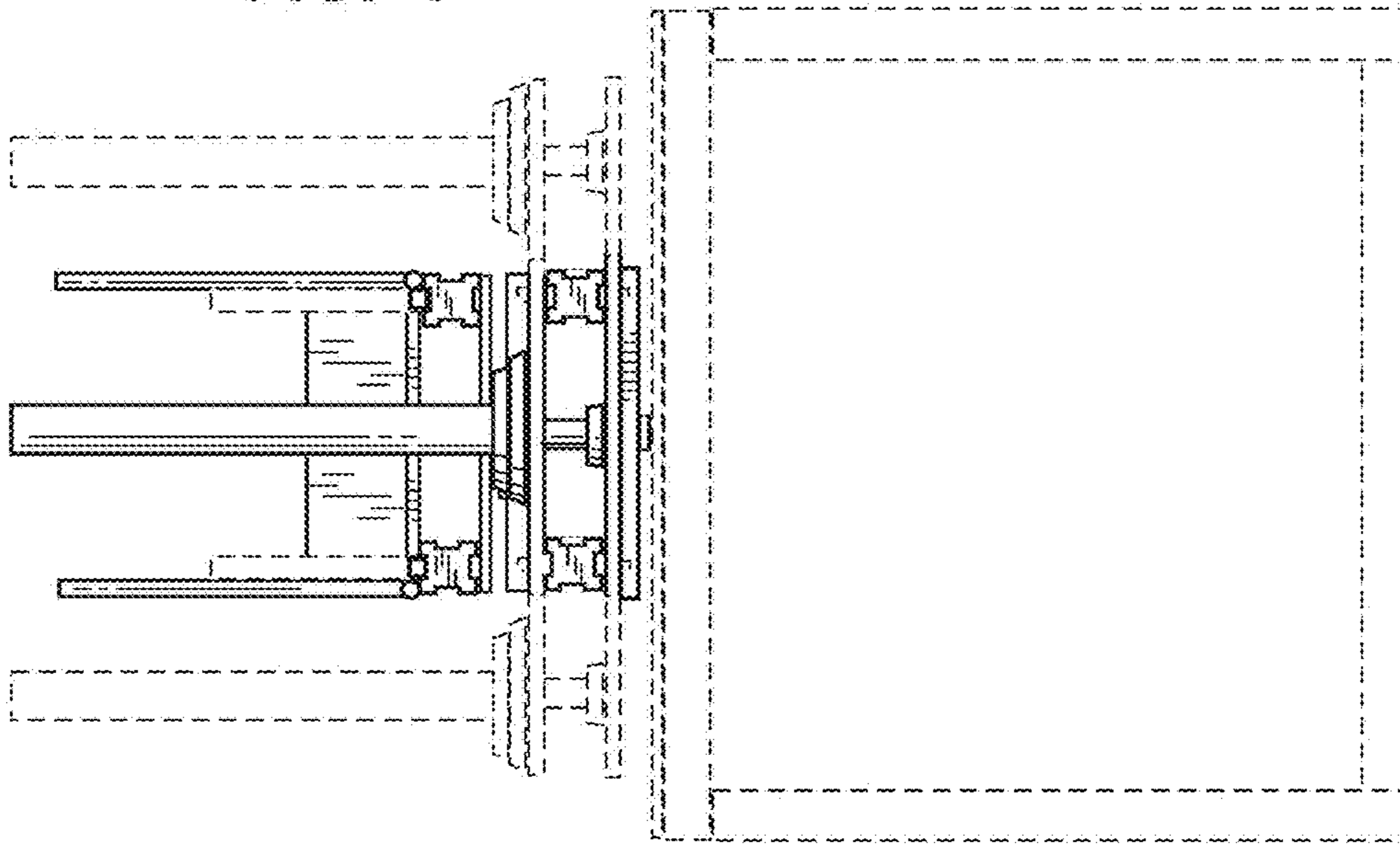

FIG. 6

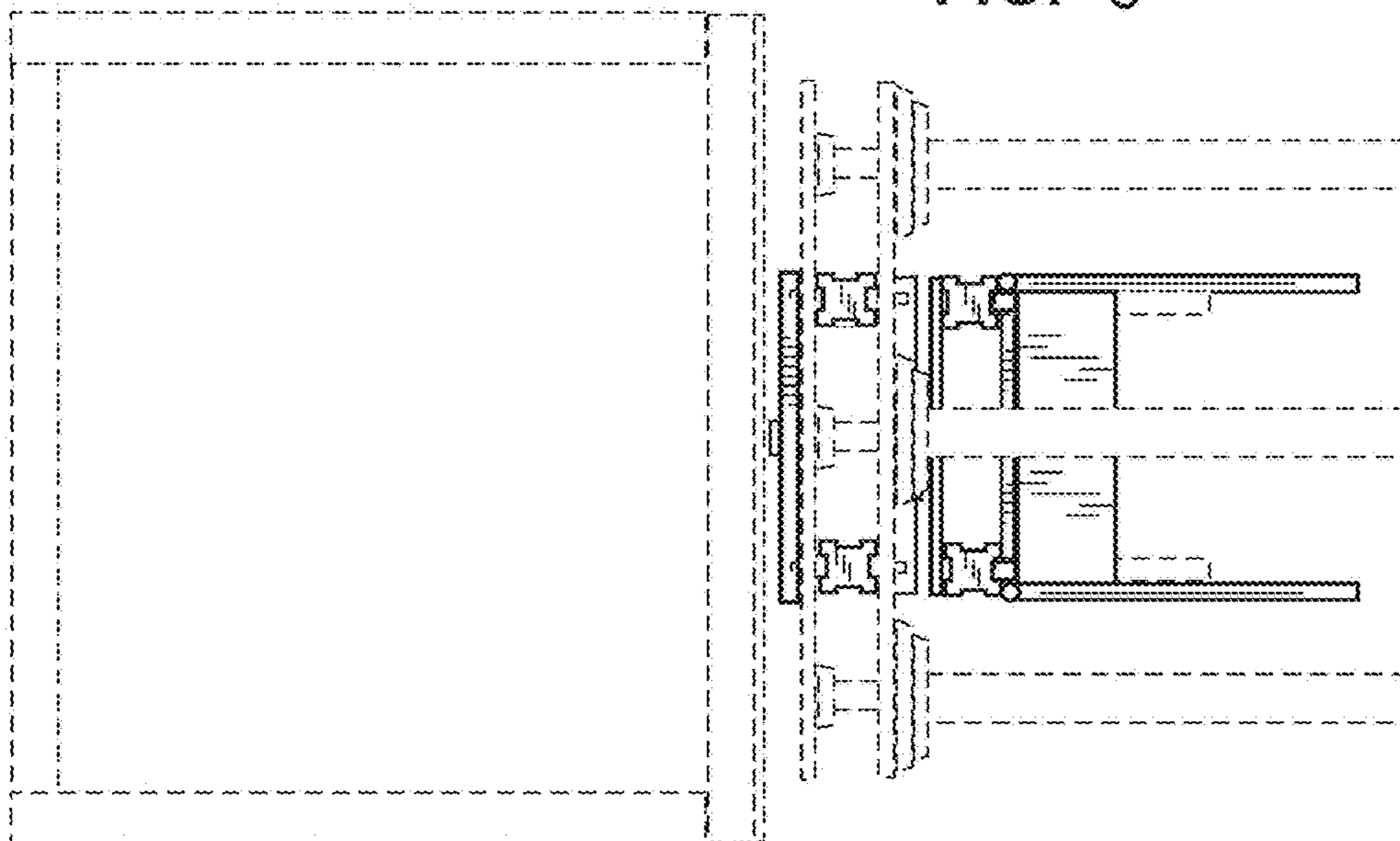

FIG. 7

