



US00D826963S

(12) **United States Design Patent** (10) **Patent No.:** **US D826,963 S**
Guan et al. (45) **Date of Patent:** **** Aug. 28, 2018**

(54) **DISPLAY SCREEN WITH ANIMATED GRAPHICAL USER INTERFACE**

(71) Applicant: **Lucis Technologies Holdings Limited**, Grand Cayman (KY)

(72) Inventors: **Shan Guan**, Fremont, CA (US); **Xiaolin Shi**, Hangzhou (CN)

(73) Assignee: **Lucis Technologies Holdings Limited**, Grand Cayman (KY)

(**) Term: **15 Years**

(21) Appl. No.: **29/578,178**

(22) Filed: **Sep. 19, 2016**

Related U.S. Application Data

(62) Division of application No. 29/541,560, filed on Oct. 5, 2015.

Foreign Application Priority Data

Apr. 3, 2015 (CN) 2015 3 0086763

(51) **LOC (11) Cl.** **14-04**

(52) **U.S. Cl.**
USPC **D14/486**

(58) **Field of Classification Search**
USPC D14/485-495

(Continued)

(56) **References Cited**

U.S. PATENT DOCUMENTS

D497,364 S 10/2004 Ozolins et al.
D500,037 S 12/2004 Ozolins et al.

(Continued)

OTHER PUBLICATIONS

Sentri: Welcome to a Smarter Home, announced Jun. 13, 2014 [online], [site visited Dec. 23, 2016]. Available from Internet, URL: <<https://www.youtube.com/watch?v=m7bmUyrMoDk>>.

(Continued)

Primary Examiner — Barbara Fox
Assistant Examiner — Dana K Weiland
(74) *Attorney, Agent, or Firm* — Metis IP LLC

(57) **CLAIM**

The ornamental design for a display screen with animated graphical user interface, as shown and described.

DESCRIPTION

FIG. 1 is the first image in a sequence of a display screen with animated graphical user interface showing our new design;

FIG. 2 is the second image thereof;

FIG. 3 is the third image thereof;

FIG. 4 is the fourth image thereof;

FIG. 5 is the fifth image thereof;

FIG. 6 is the sixth image thereof;

FIG. 7 is the seventh image thereof;

FIG. 8 is the eighth image thereof;

FIG. 9 is the ninth image thereof;

FIG. 10 is the tenth image thereof;

FIG. 11 is the eleventh image thereof;

FIG. 12 is the twelfth image thereof;

FIG. 13 is the thirteenth image thereof;

FIG. 14 is the fourteenth image thereof;

FIG. 15 is the fifteenth image thereof;

FIG. 16 is the sixteenth image thereof;

FIG. 17 is the seventeenth image thereof;

FIG. 18 is the eighteenth image thereof;

FIG. 19 is the nineteenth image thereof; and,

FIG. 20 is the twentieth image thereof.

The broken lines in the drawings depict a display screen and portions of an animated graphical user interface that form no part of the claimed design.

1 Claim, 20 Drawing Sheets

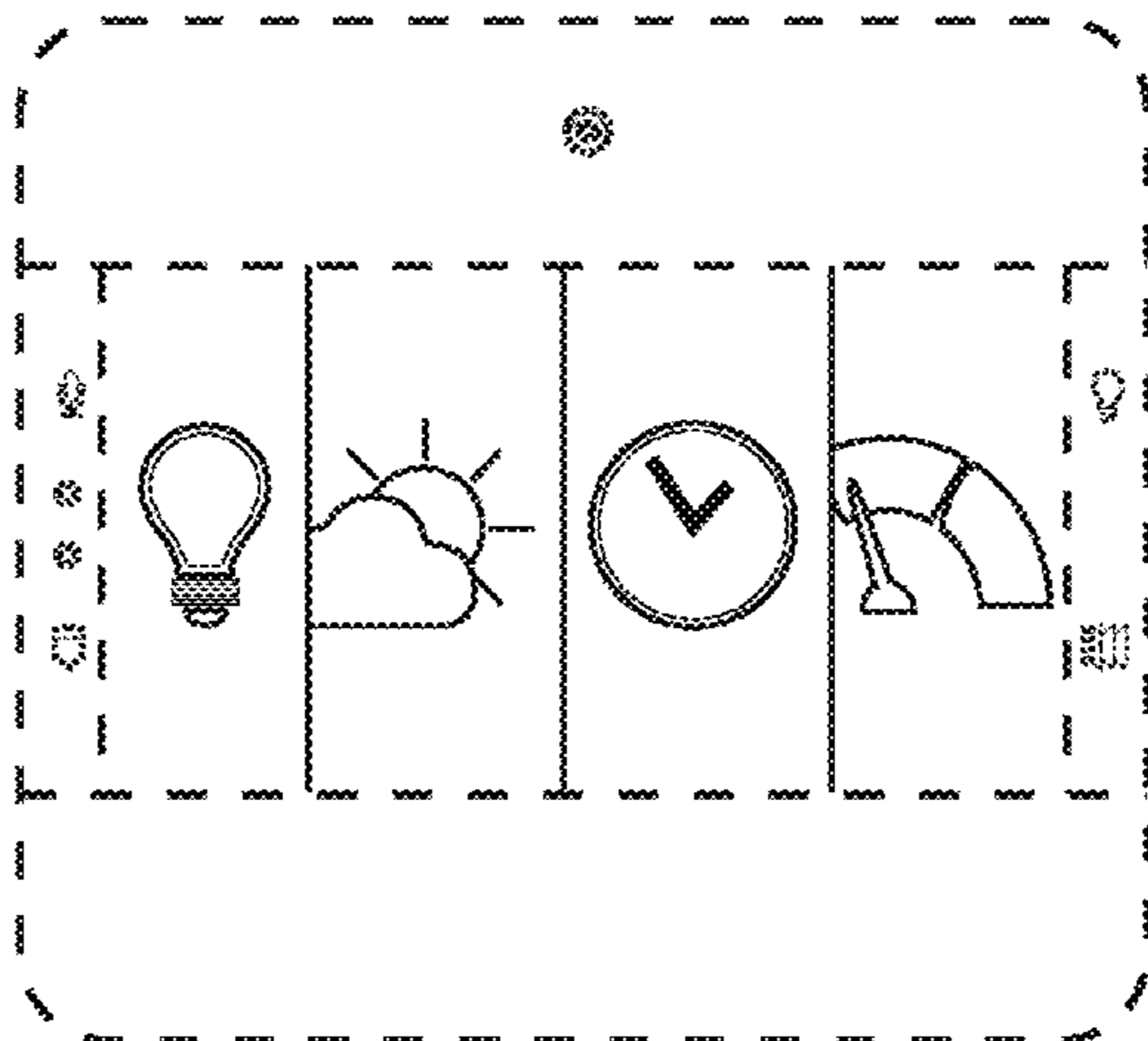

(58) **Field of Classification Search**

CPC . A63F 2300/308; G01C 21/36; G06F 1/1692;
G06F 17/24; G06F 17/243; G06F 17/246;
G06F 17/30115; G06F 3/0481; G06F
3/04817; G06F 3/04845; G06F 3/04847;
G06F 3/0488; G06F 2203/04808; G06T
13/80; G06T 15/02; H04N 1/00408;
H04N 1/00424; H04N 1/00437

See application file for complete search history.

(56) **References Cited**

U.S. PATENT DOCUMENTS

D582,800 S 12/2008 Comerford et al.
D590,412 S * 4/2009 Saft D14/486
D593,577 S * 6/2009 Baumann D14/487
D622,513 S 8/2010 Tang et al.
D623,194 S * 9/2010 Cook D14/488
D625,323 S * 10/2010 Matsushima D14/487
D638,025 S * 5/2011 Saft D14/486
D639,266 S 6/2011 DeLorenzo et al.
D646,258 S 10/2011 Van Der Flier et al.
D648,641 S 11/2011 Wallaert et al.
D656,136 S 3/2012 Lee
D678,218 S 3/2013 Sheen
D685,817 S * 7/2013 Kunieda D14/487
D690,661 S 10/2013 Wisniewski et al.
D692,910 S * 11/2013 Anzures D14/486
8,595,649 B2 * 11/2013 Sherrard G06F 3/04817
715/739
D695,410 S 12/2013 Becker
D701,230 S * 3/2014 Lee D14/486
D701,519 S * 3/2014 Campiranon D14/486
D704,186 S 5/2014 Bajwa et al.
D718,334 S * 11/2014 Cranfill D14/489
D719,107 S 12/2014 Clymer et al.
D722,986 S 2/2015 Zwier et al.
D727,321 S 4/2015 LaBorde et al.
D728,618 S * 5/2015 Bae D14/492
D730,928 S * 6/2015 Lee D14/486
D732,057 S * 6/2015 Jeong D14/486
D733,591 S 7/2015 Golden et al.
D737,154 S * 8/2015 Jacoby D10/50
D737,697 S 9/2015 Bhattacharya
D738,756 S 9/2015 Jiang et al.
D739,773 S 9/2015 Kanenari et al.
D741,269 S 10/2015 Bhattacharya et al.
D742,335 S 11/2015 Yamaguchi
D744,433 S 12/2015 Baumgartner et al.
D748,504 S 2/2016 Rump
D751,426 S 3/2016 Edgar
D752,598 S * 3/2016 Romanoff D14/485
D755,132 S 5/2016 Kashimoto
D755,734 S 5/2016 Kashimoto
D755,735 S 5/2016 Kashimoto
D758,217 S 6/2016 Kumfer et al.
D761,260 S 7/2016 Luo
D763,205 S 8/2016 Kashimoto
D764,418 S 8/2016 Kashimoto

D764,419 S 8/2016 Kashimoto
D766,310 S * 9/2016 Jiang D14/488
D769,241 S 10/2016 Mazz et al.
D771,703 S * 11/2016 Asai D14/491
D777,683 S 1/2017 Kashimoto
D778,244 S 2/2017 Feldstein et al.
D778,245 S * 2/2017 Feldstein D13/162
9,568,891 B2 * 2/2017 Adams G04G 21/08
D783,640 S * 4/2017 Apodaca D14/485
D783,652 S * 4/2017 Guan D14/486
D783,672 S * 4/2017 Rajasankar D14/488
D784,390 S * 4/2017 Dye D14/486
D785,004 S * 4/2017 Bell D14/485
D785,025 S * 4/2017 Zimmerman D14/486
D785,658 S * 5/2017 Moroney D14/486
D786,913 S * 5/2017 Dye D14/486
D786,915 S * 5/2017 Kim D14/487
D791,814 S * 7/2017 Chaudhri D14/487
D797,783 S * 9/2017 Broughton D14/486
D798,896 S * 10/2017 Chaudhri D14/487
D800,751 S * 10/2017 Hersh D14/486
D801,368 S * 10/2017 Broughton D14/486
D802,622 S * 11/2017 Clymer D14/487
2010/0328224 A1 * 12/2010 Kerr G06F 3/04883
345/173
2013/0254705 A1 * 9/2013 Mooring G06F 3/0488
715/784
2013/0268875 A1 * 10/2013 Han G06F 3/0481
715/769
2014/0059460 A1 * 2/2014 Ho G06F 3/048
715/766
2014/0067007 A1 * 3/2014 Drees A61N 1/37282
607/46
2015/0055197 A1 * 2/2015 Romanoff H04N 1/00225
358/494
2015/0227298 A1 * 8/2015 Kim G06F 3/04845
715/799
2016/0050168 A1 * 2/2016 Zutphen H04L 51/046
715/752
2016/0111878 A1 4/2016 Qureshi et al.
2016/0259488 A1 * 9/2016 Chan G06F 1/163
2016/0259535 A1 * 9/2016 Fleizach G09B 21/006

OTHER PUBLICATIONS

The NuBryte hub keeps an eye on your connected home, announced Dec. 11, 2014 [online], [site visited Dec. 23, 2016]. Available from Internet, URL: <<https://www.cnet.com/products/lucis-nubryte/pre-view/>>.
NuBryte, announced Dec. 19, 2014 [online], [site visited Dec. 23, 2016]. Available from Internet, URL: <https://www.youtube.com/watch?v=RKRNNnA_PSY>.
First look: Lucis' NuBryte cloud-connected smart home console, announced Jan. 8, 2015 [online], [site visited Dec. 23, 2016]. Available from Internet, URL: <<https://forums.appleinsider.com/discussion/184240/first-look-lucis-nubryte-cloud-connected-smarhome-console>>.

* cited by examiner

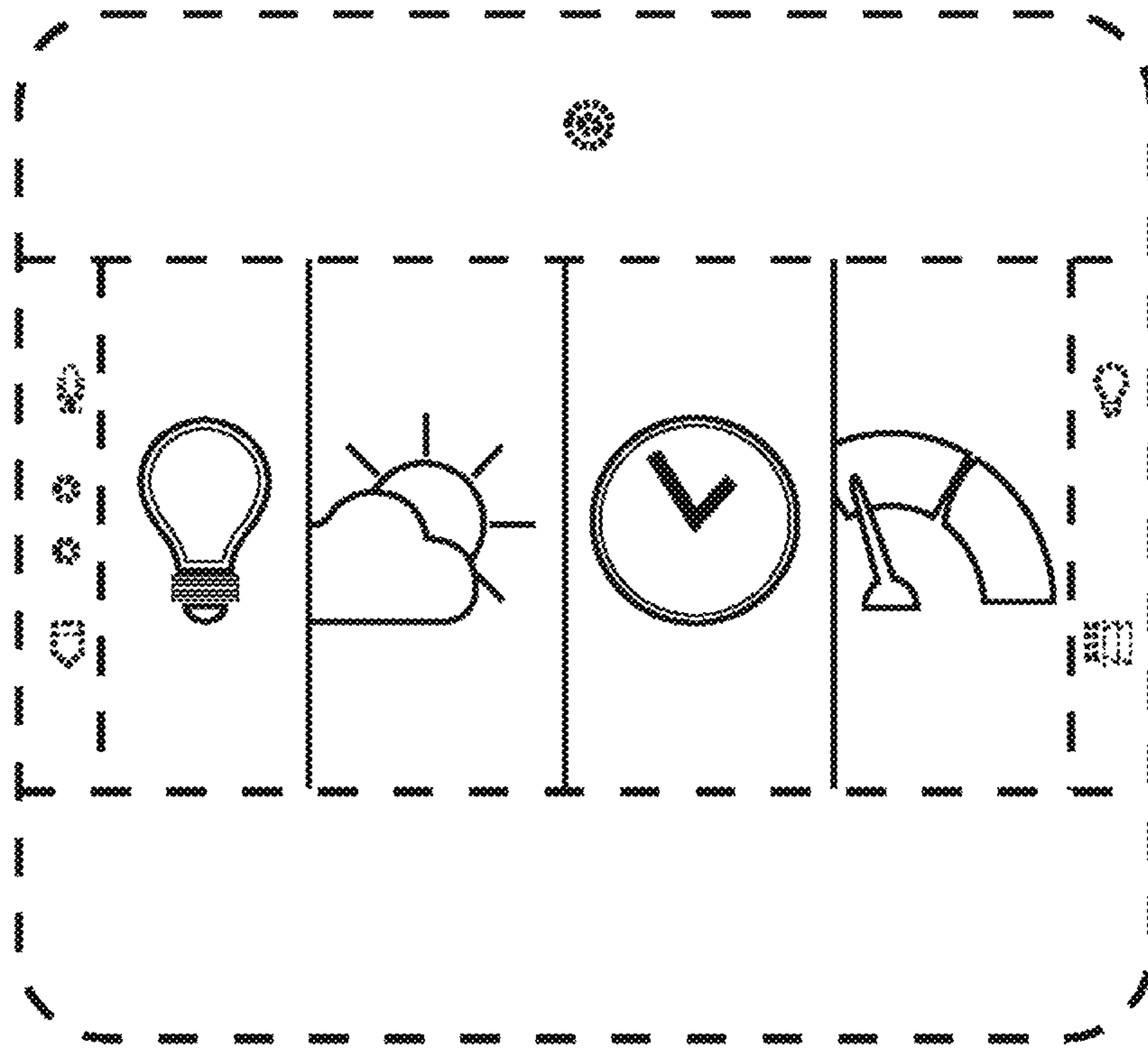

FIG. 1

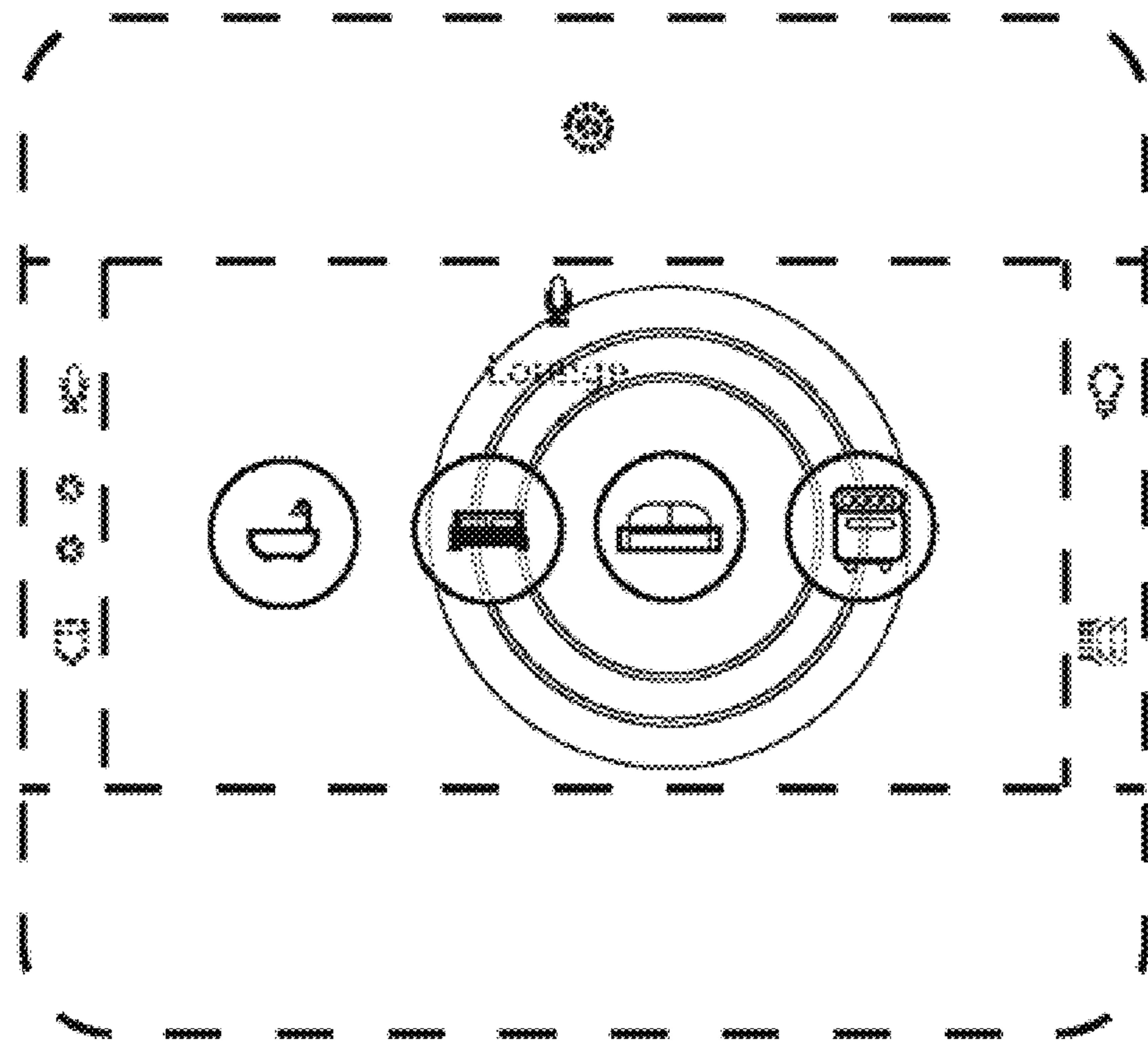

FIG. 2

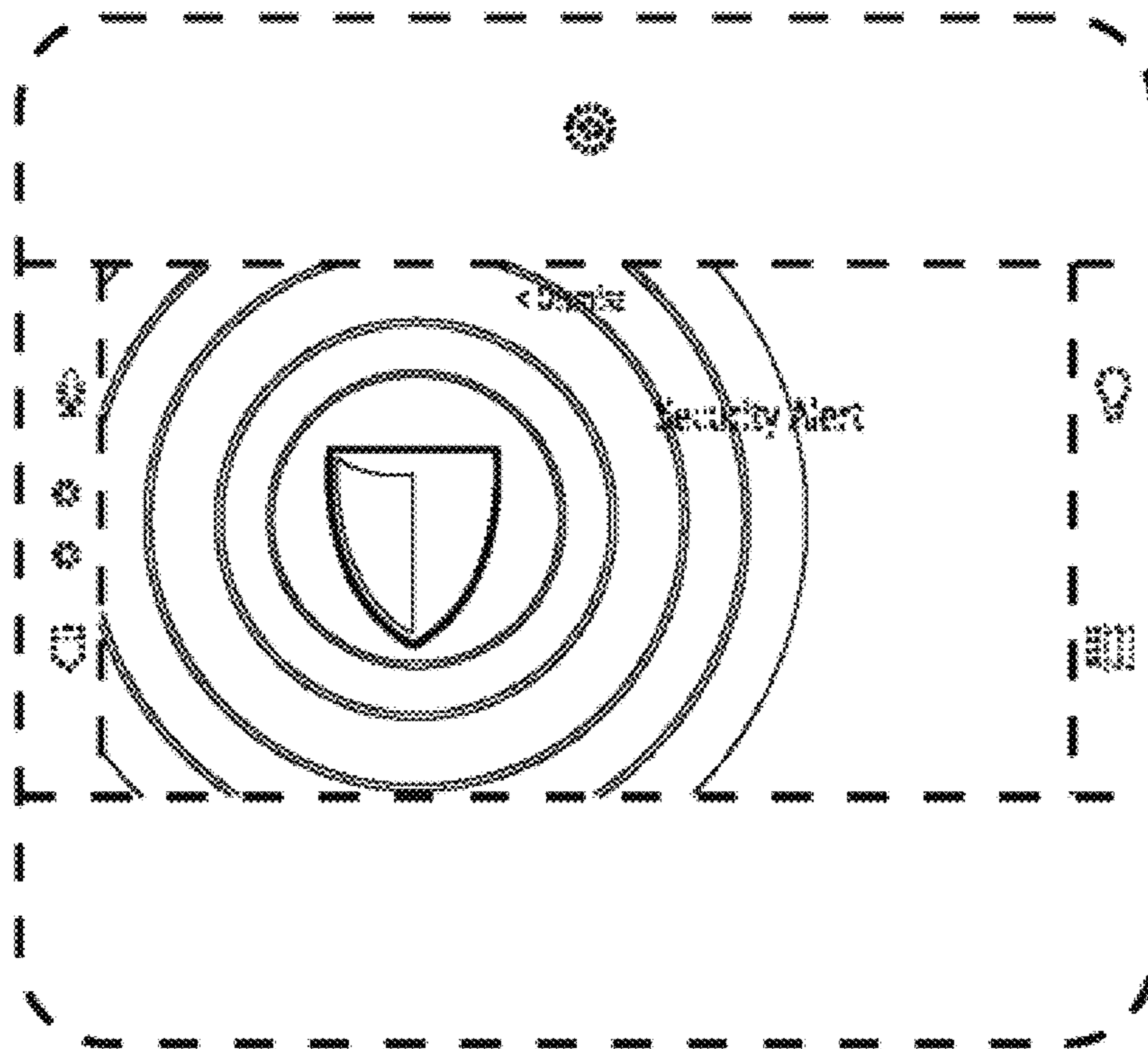

FIG. 3

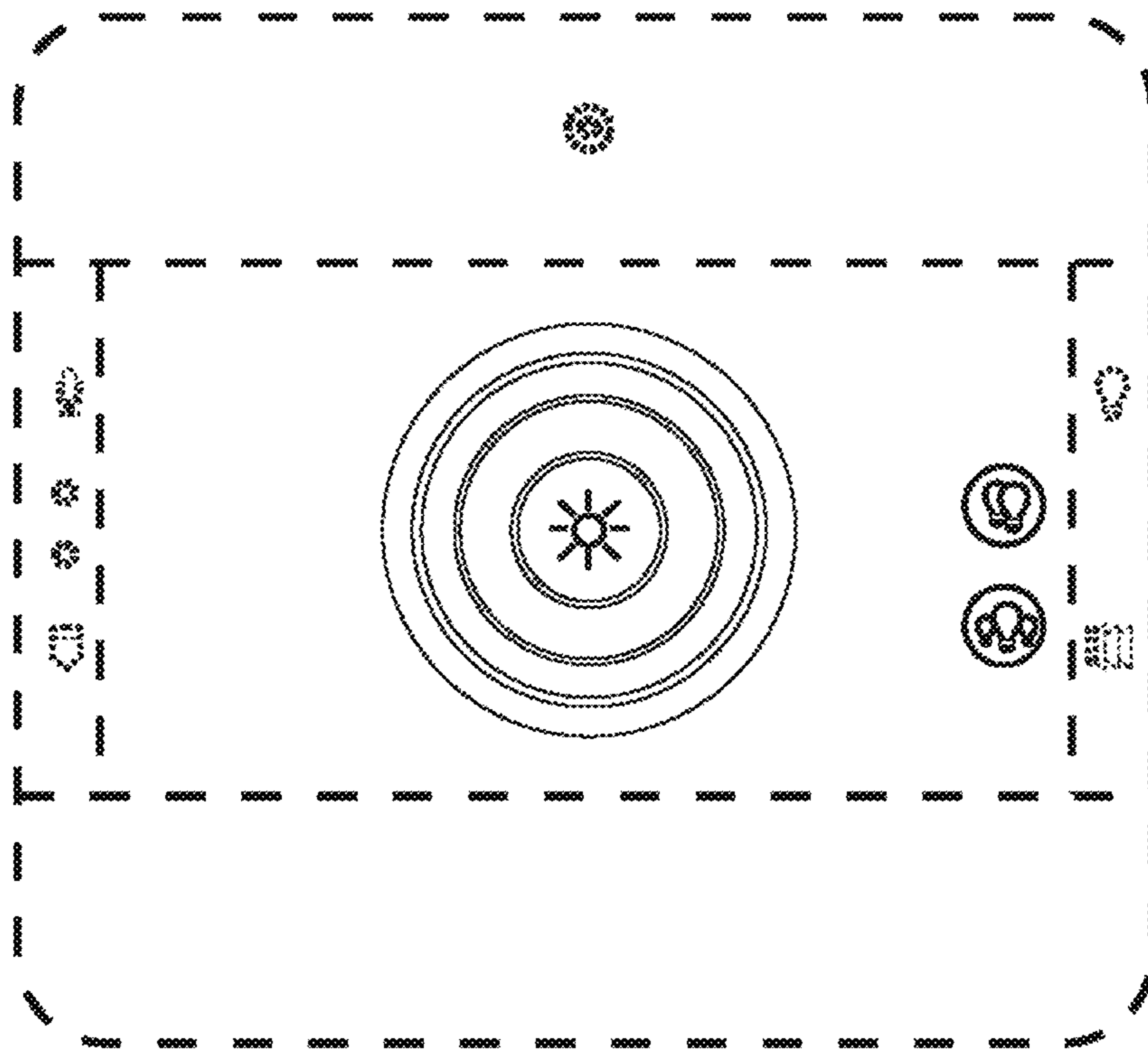

FIG. 4

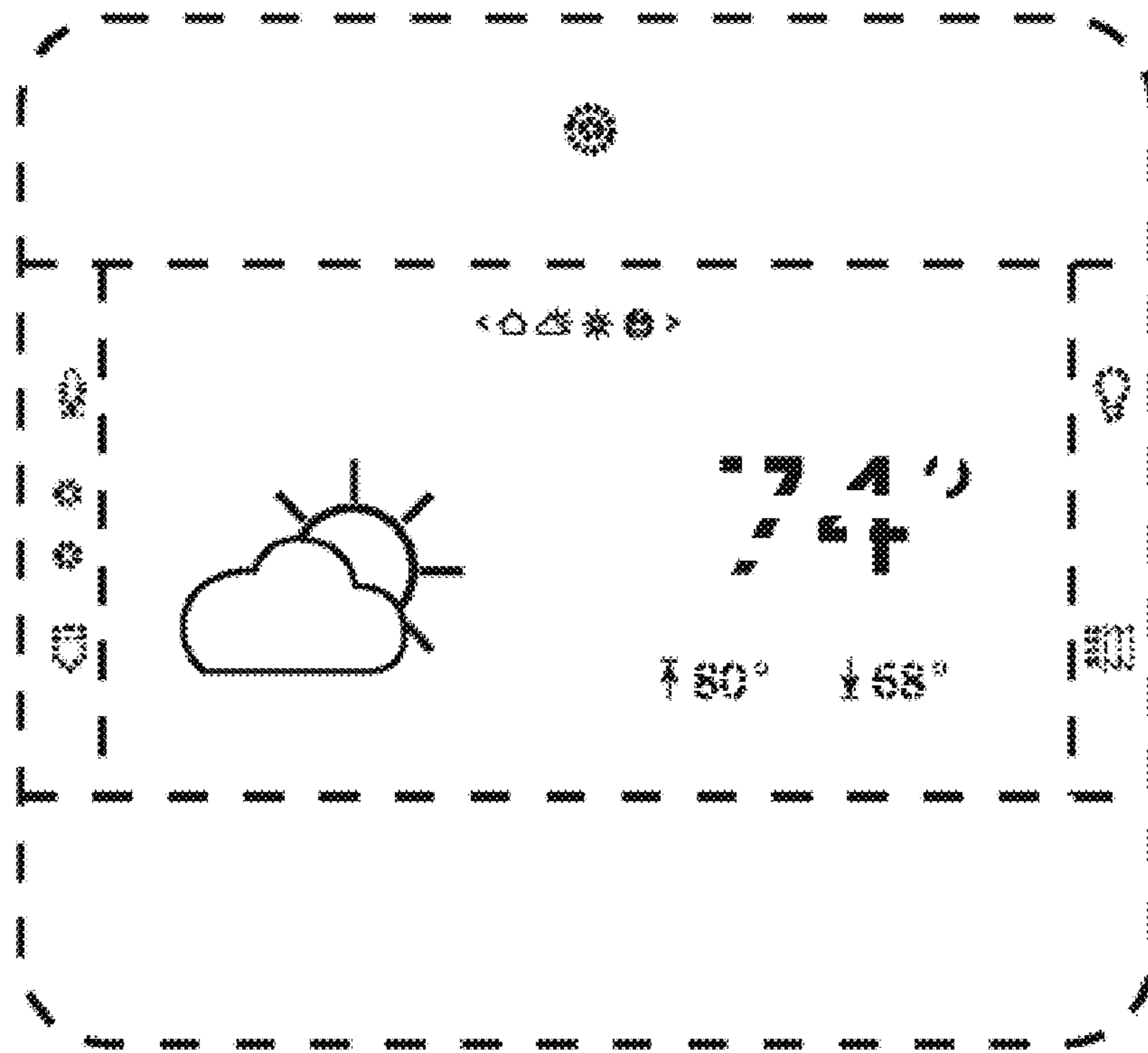

FIG. 5

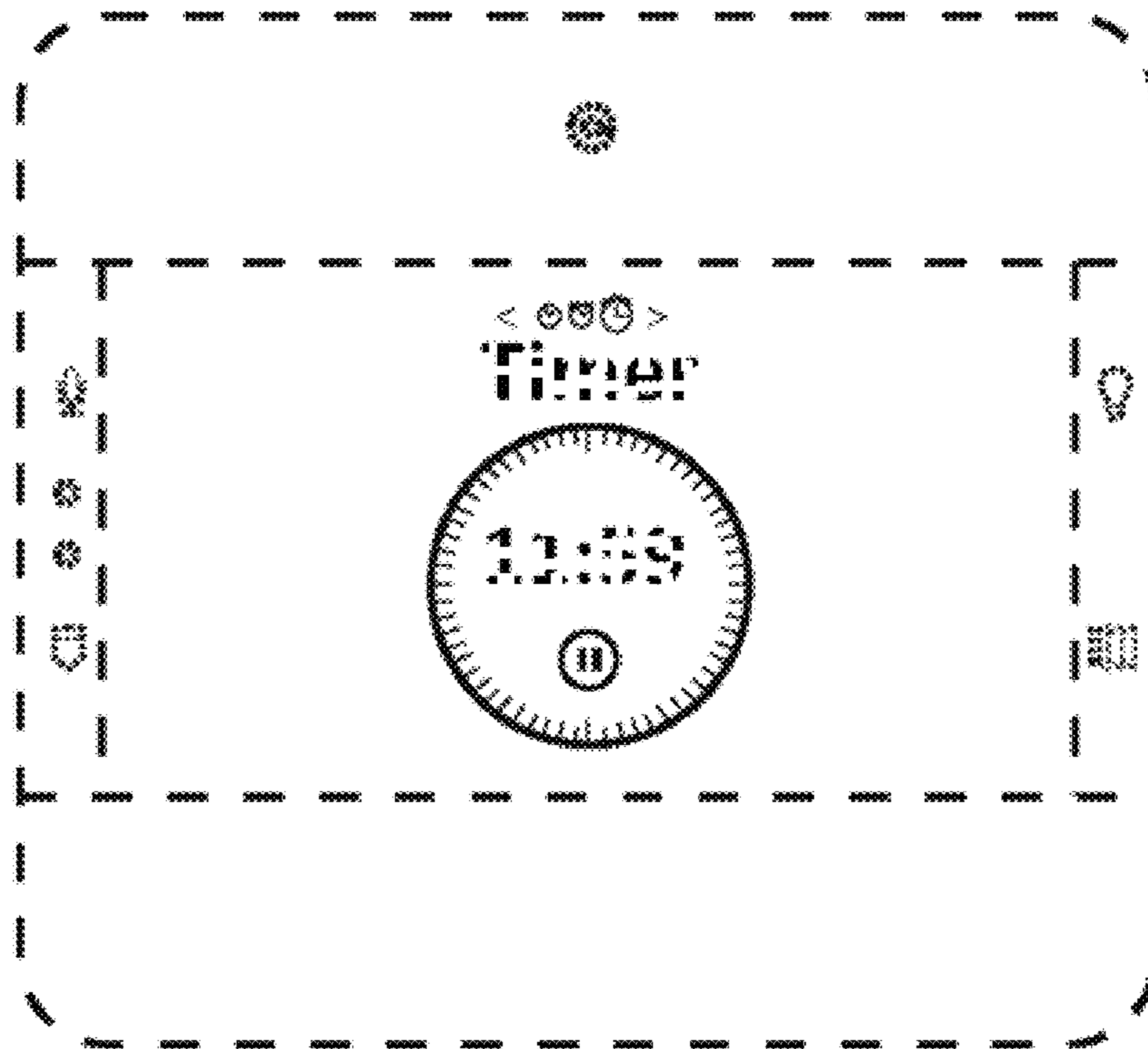

FIG. 6

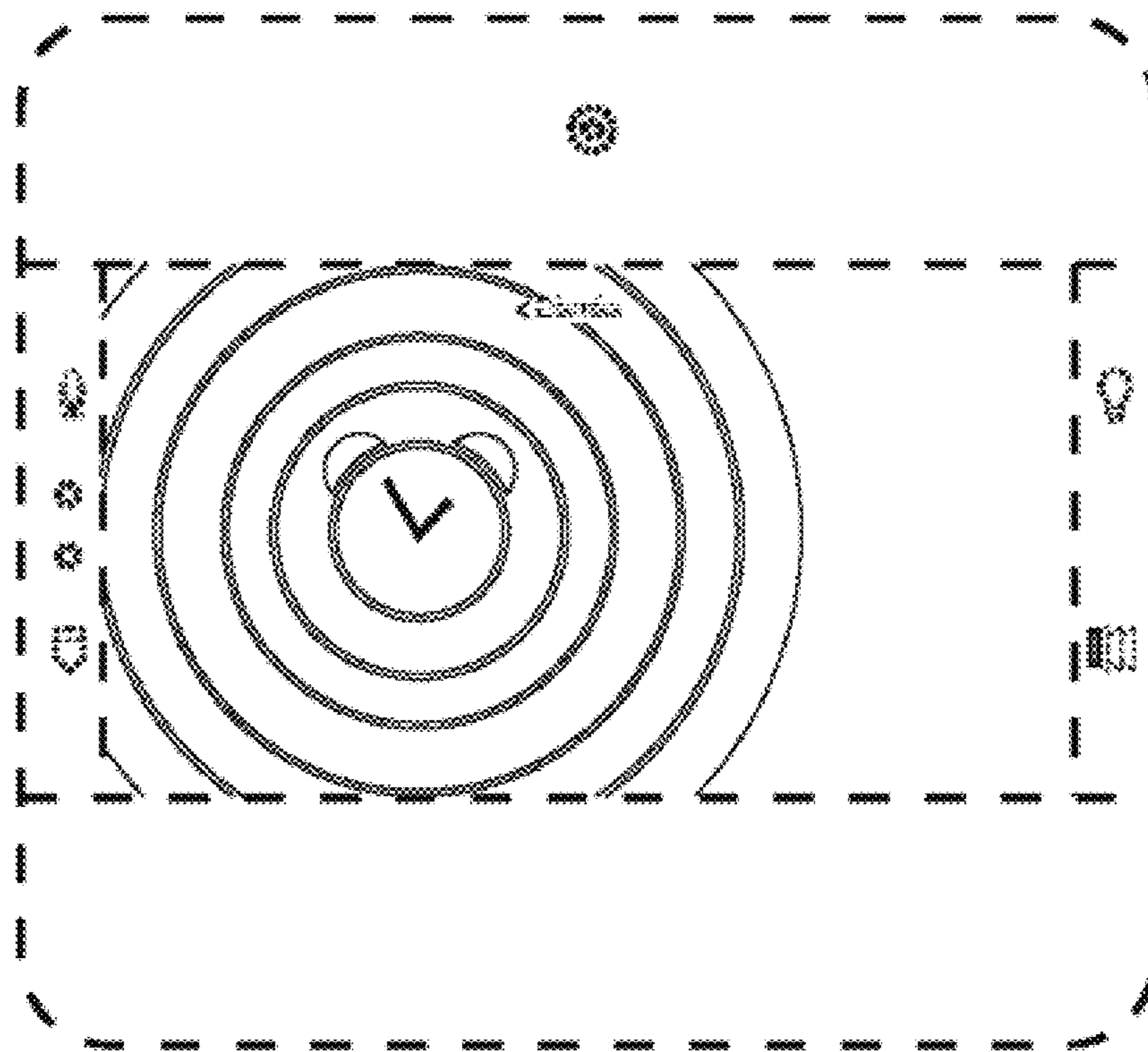

FIG. 7

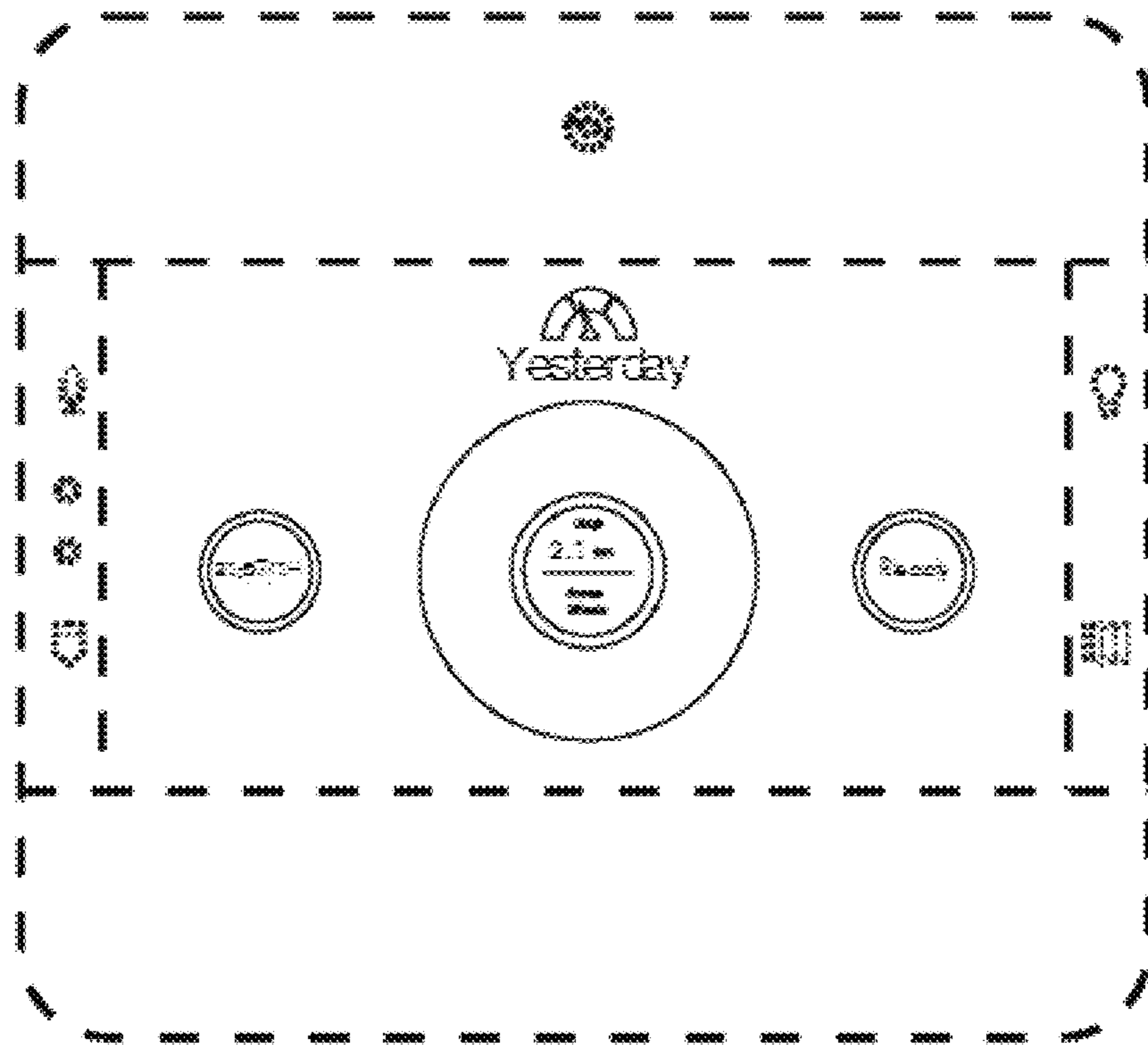

FIG. 8

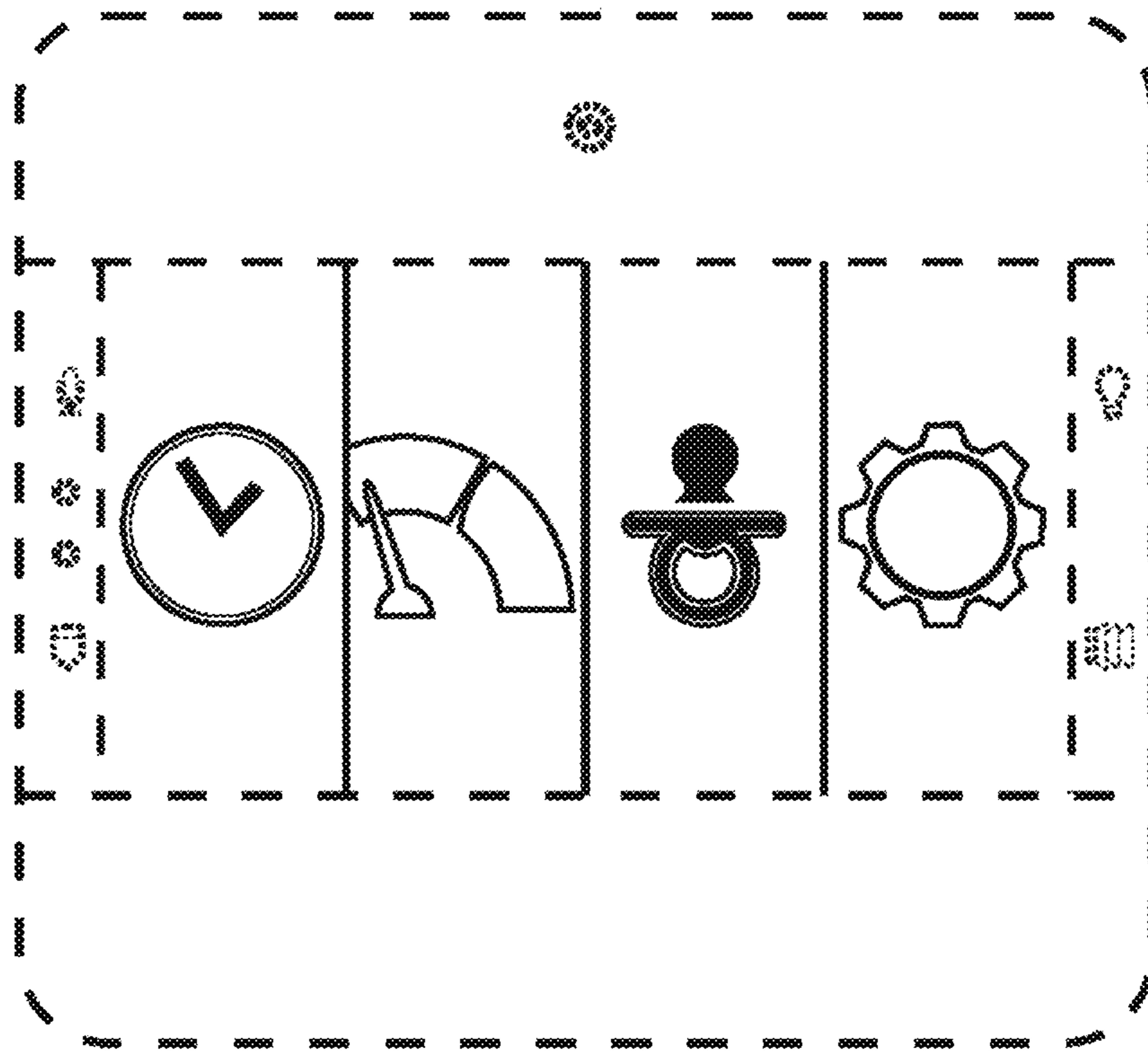

FIG. 9

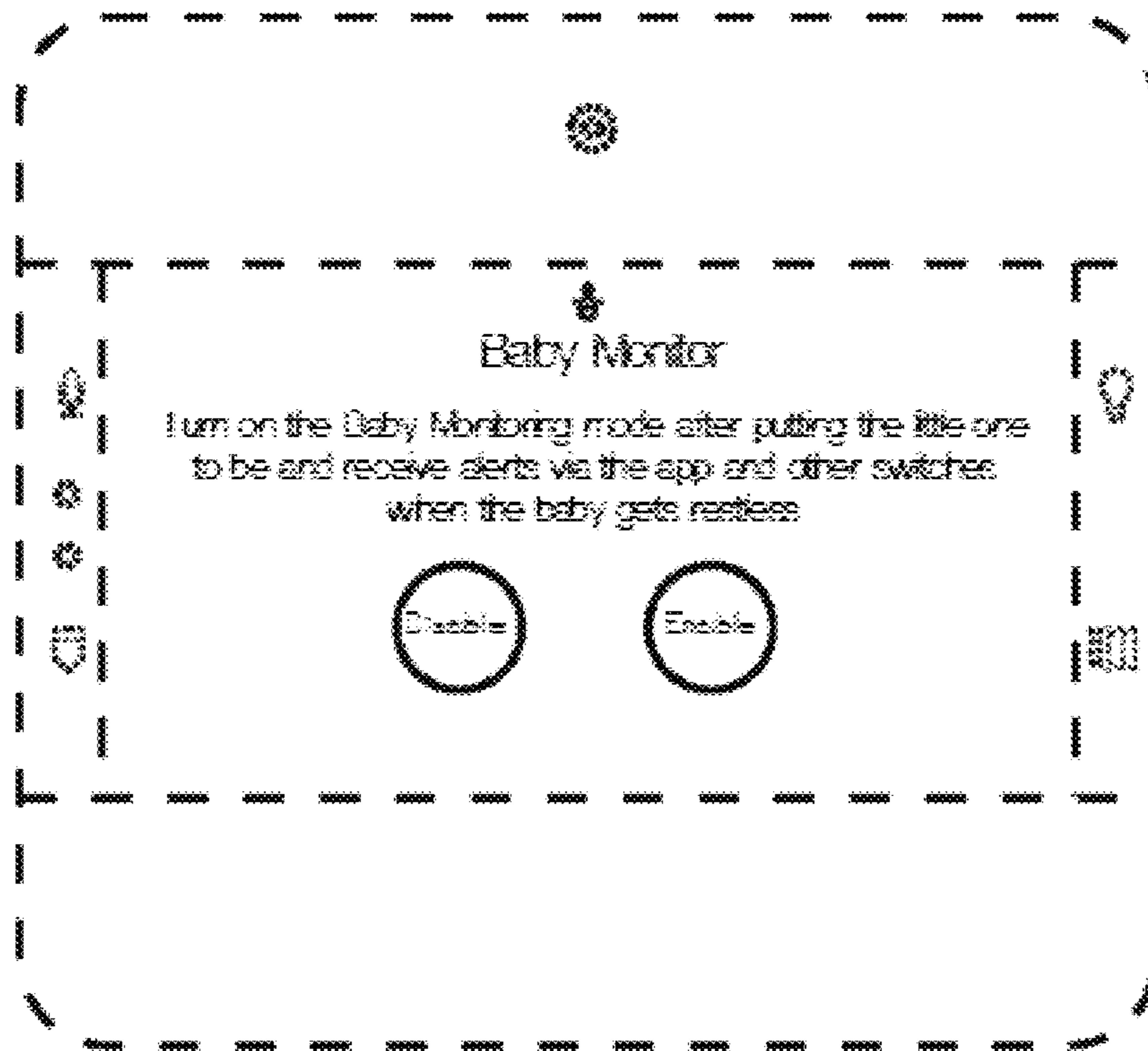

FIG. 10

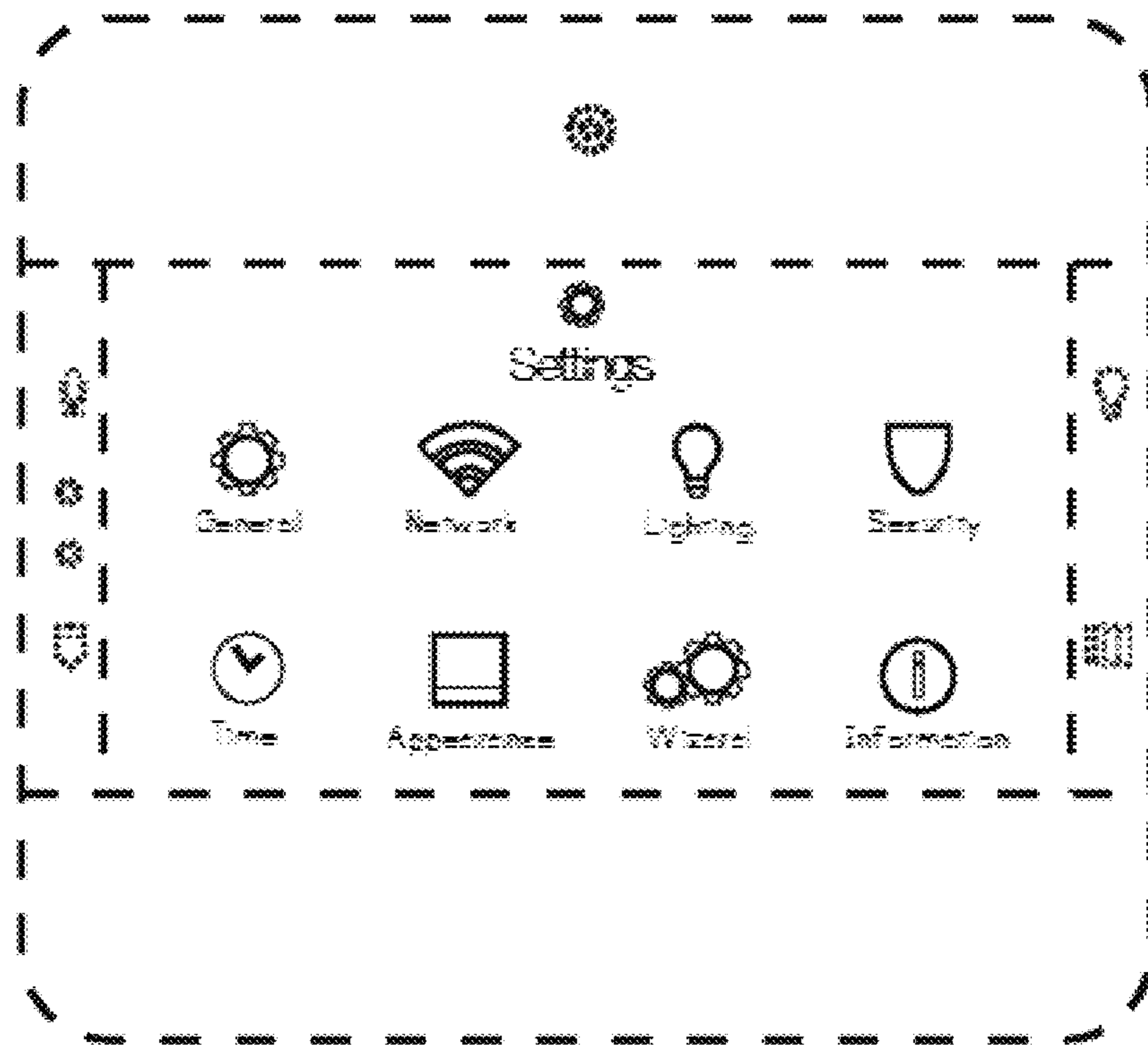

FIG. 11

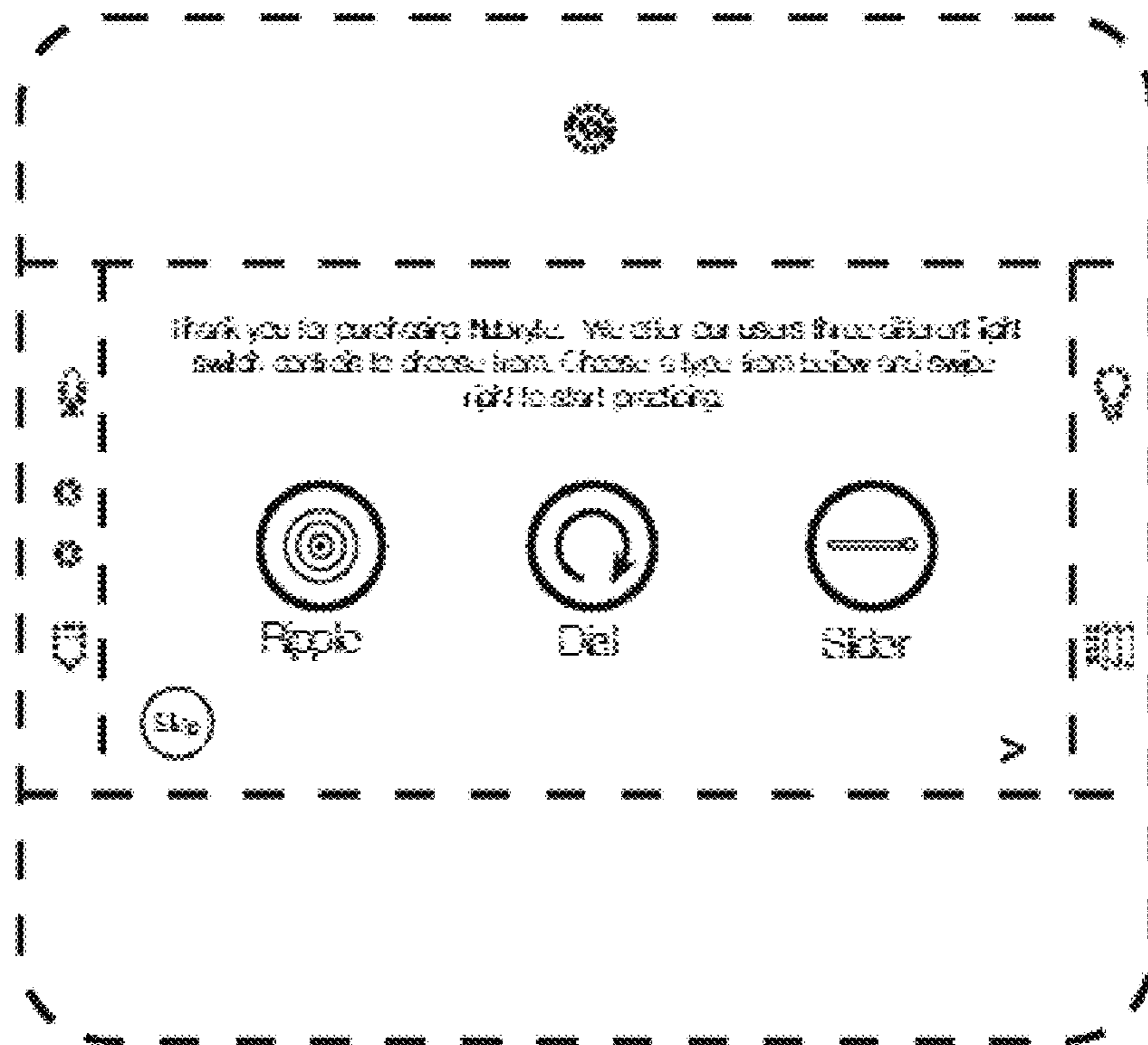

FIG. 12

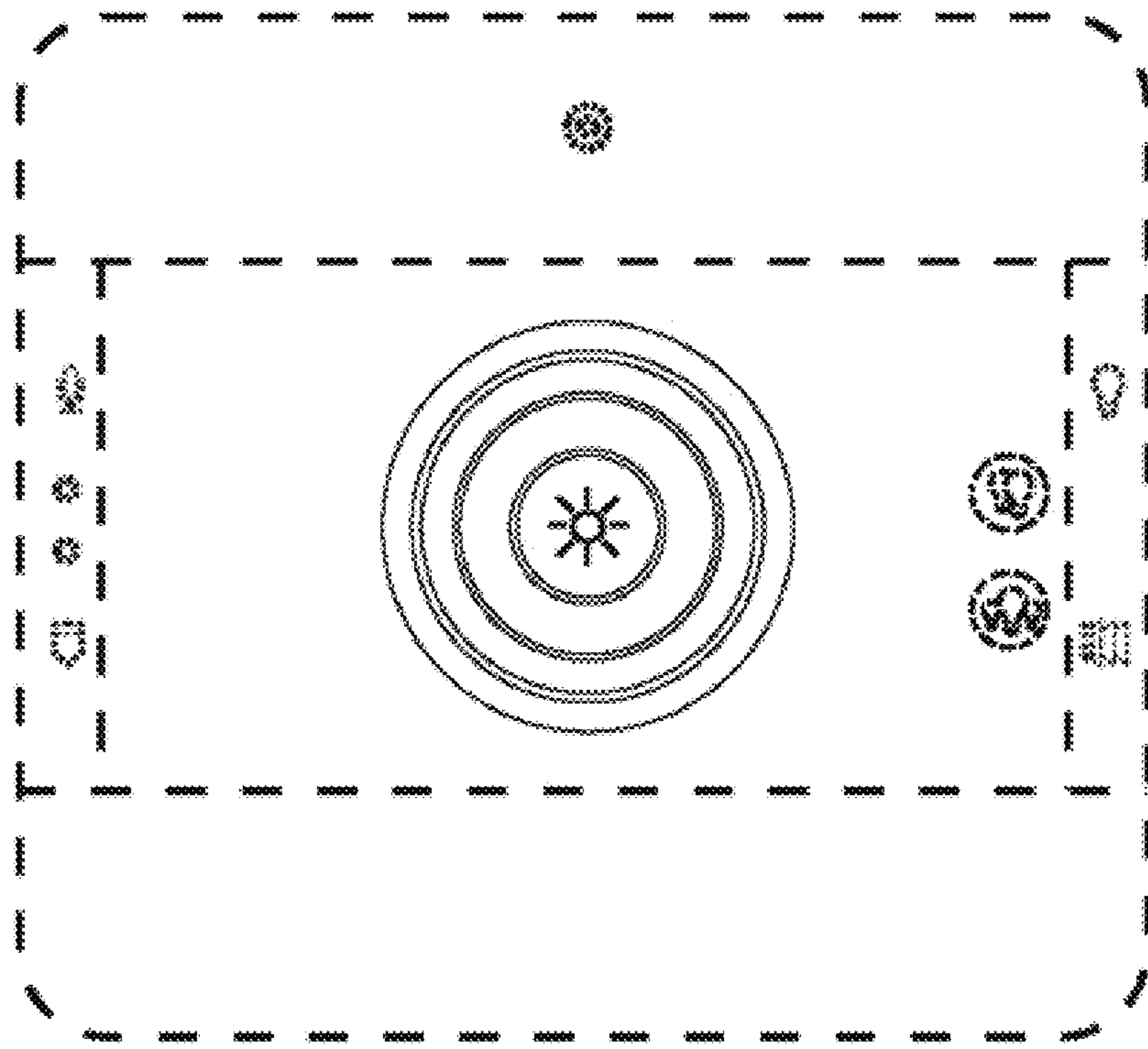

FIG. 13

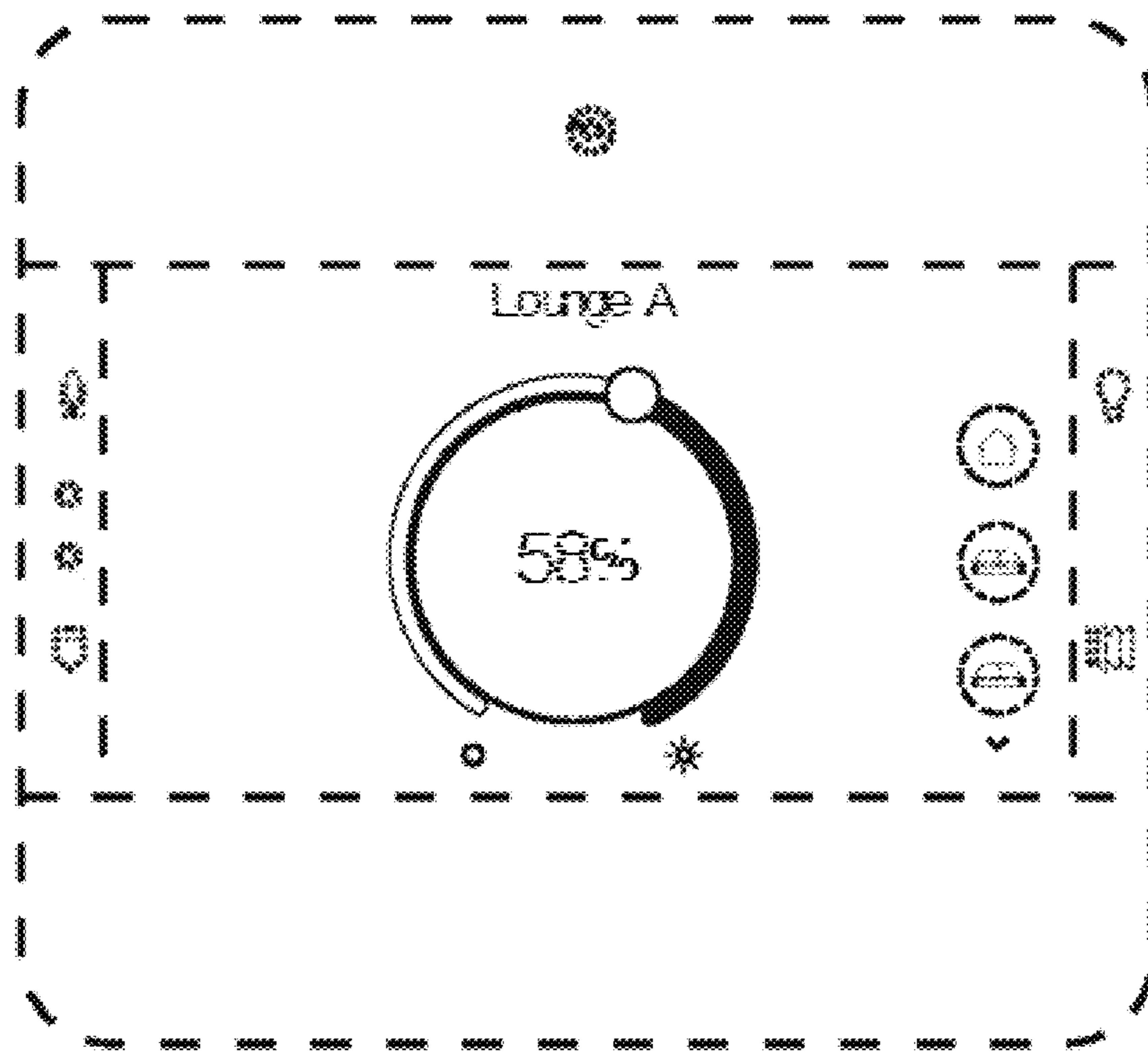

FIG. 14

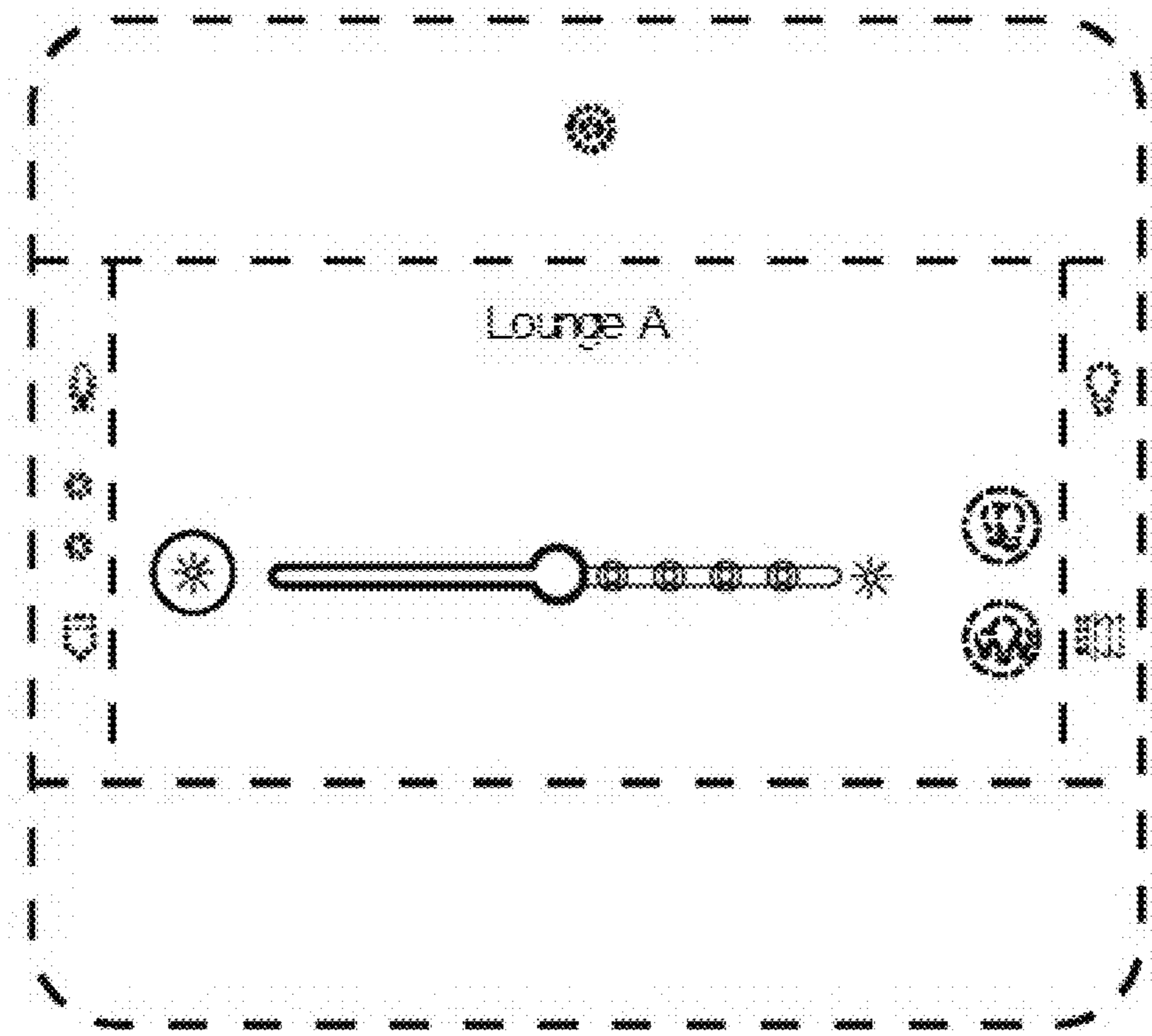

FIG. 15

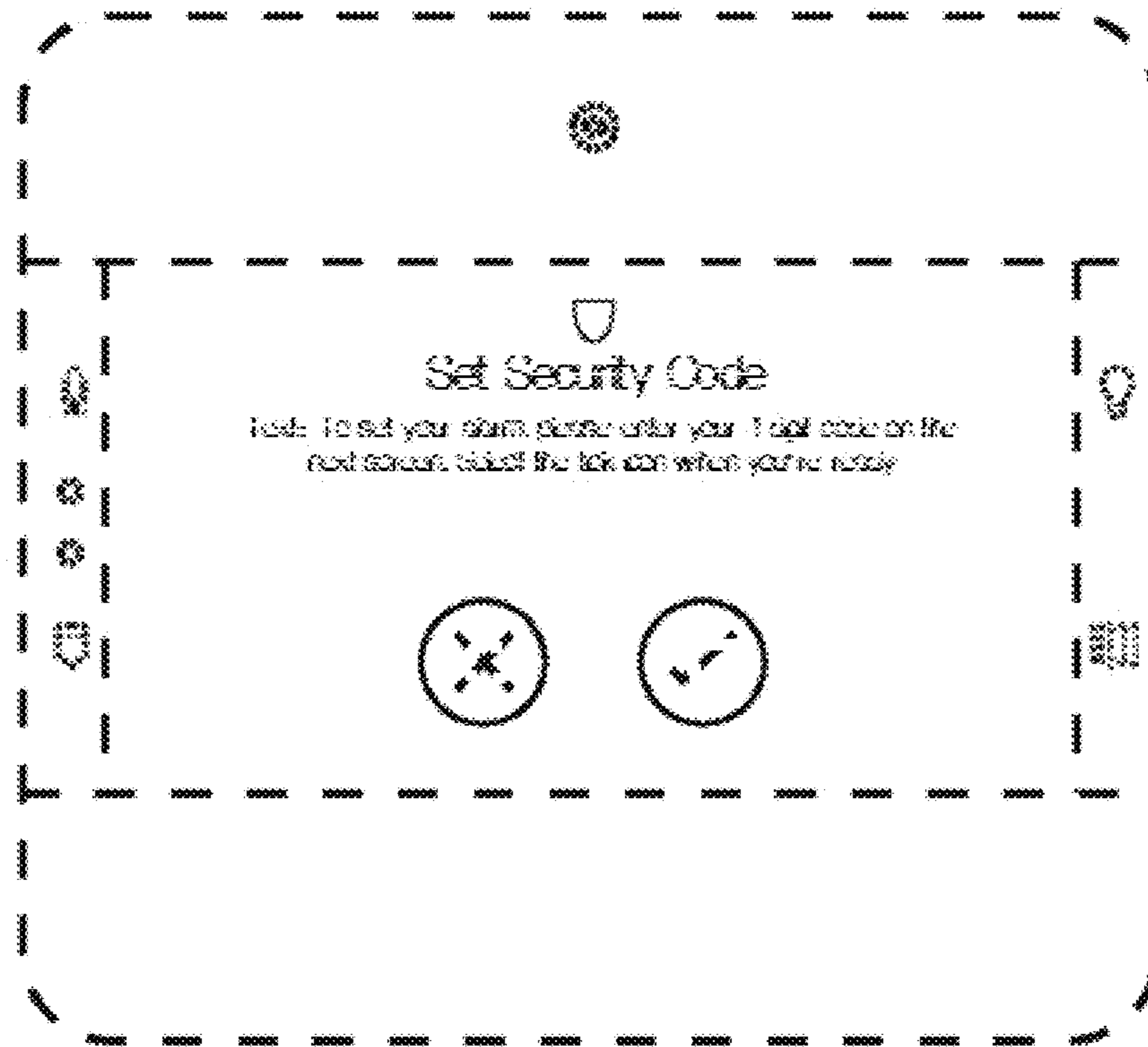

FIG. 16

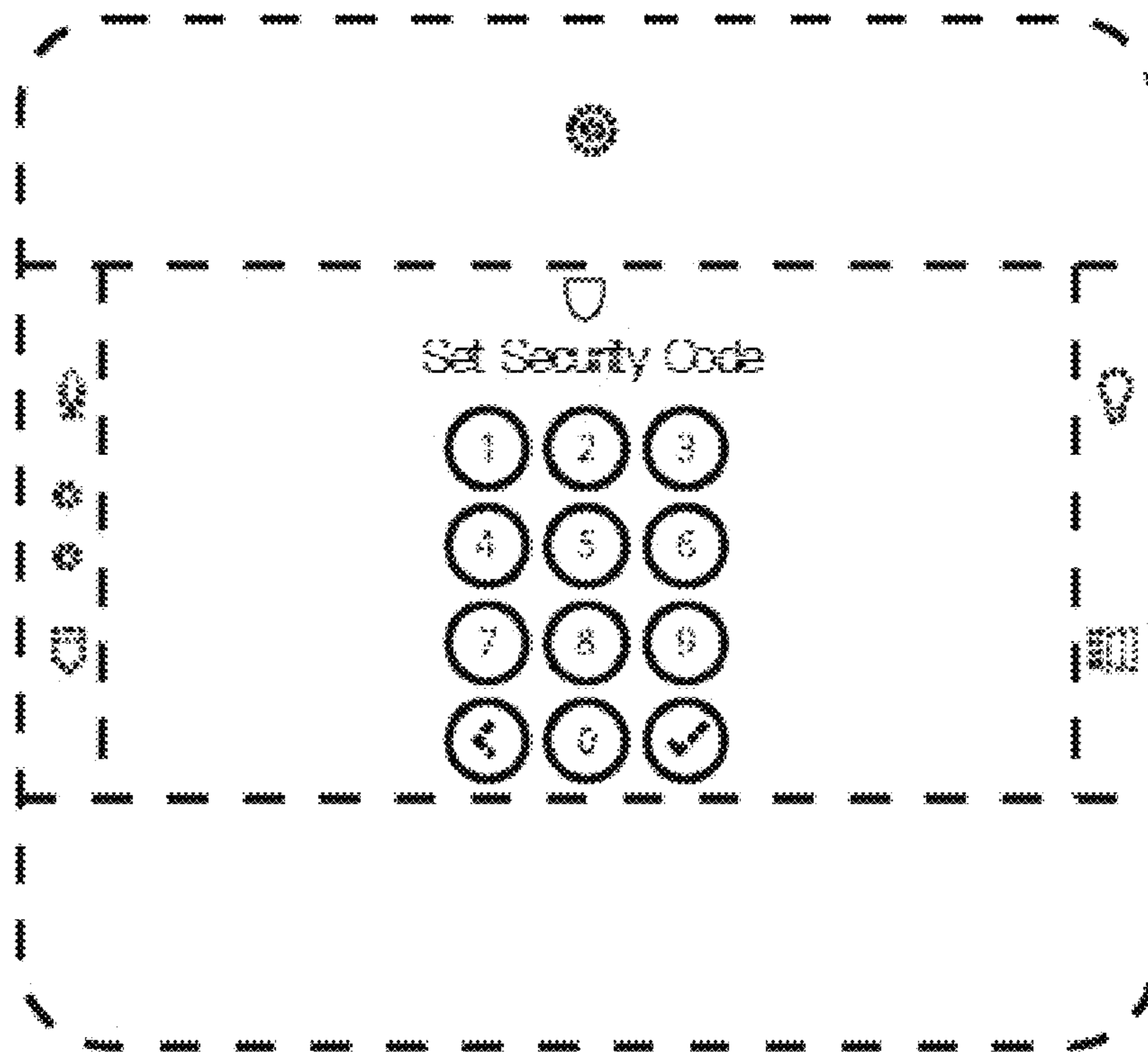

FIG. 17

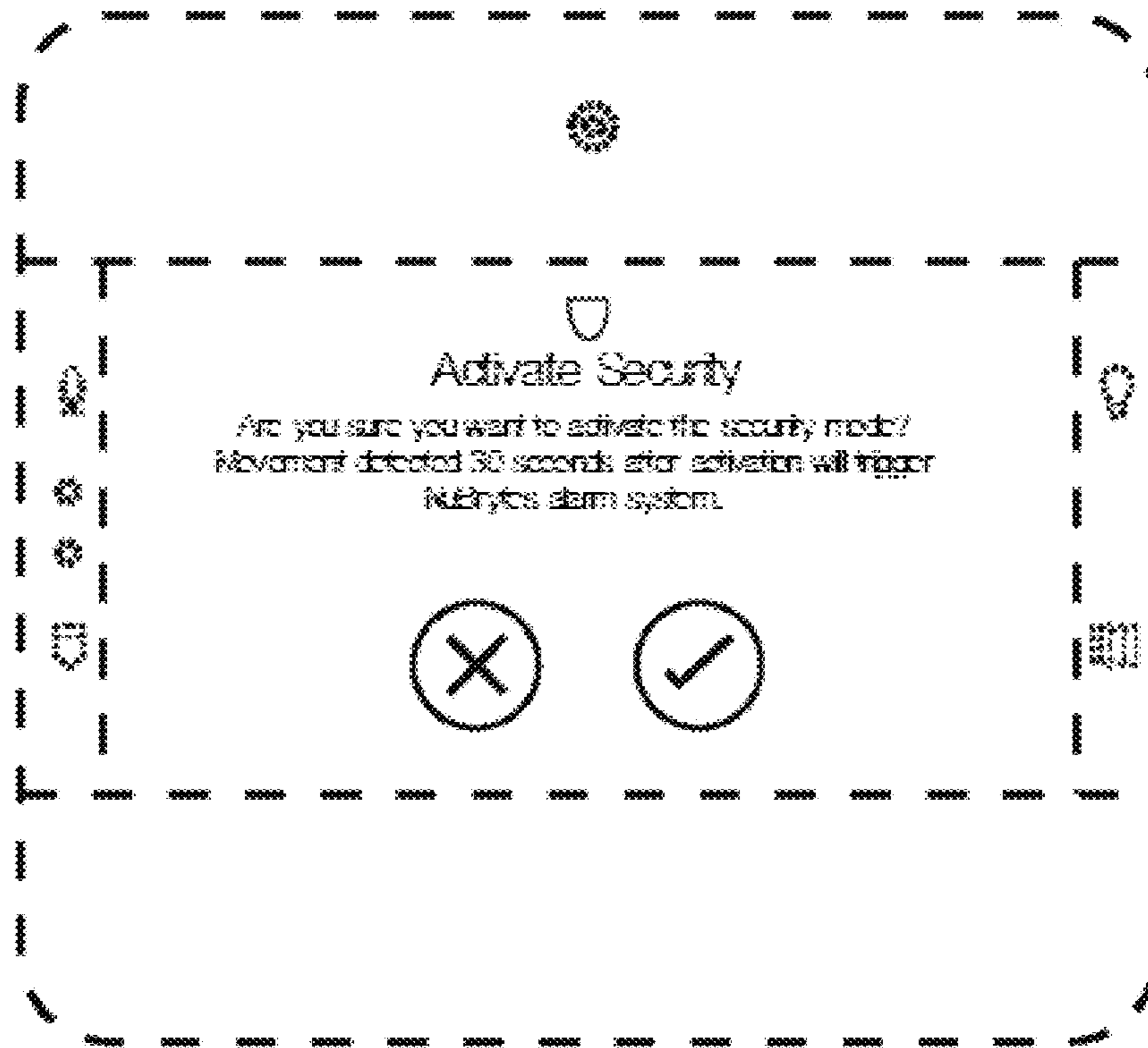

FIG. 18

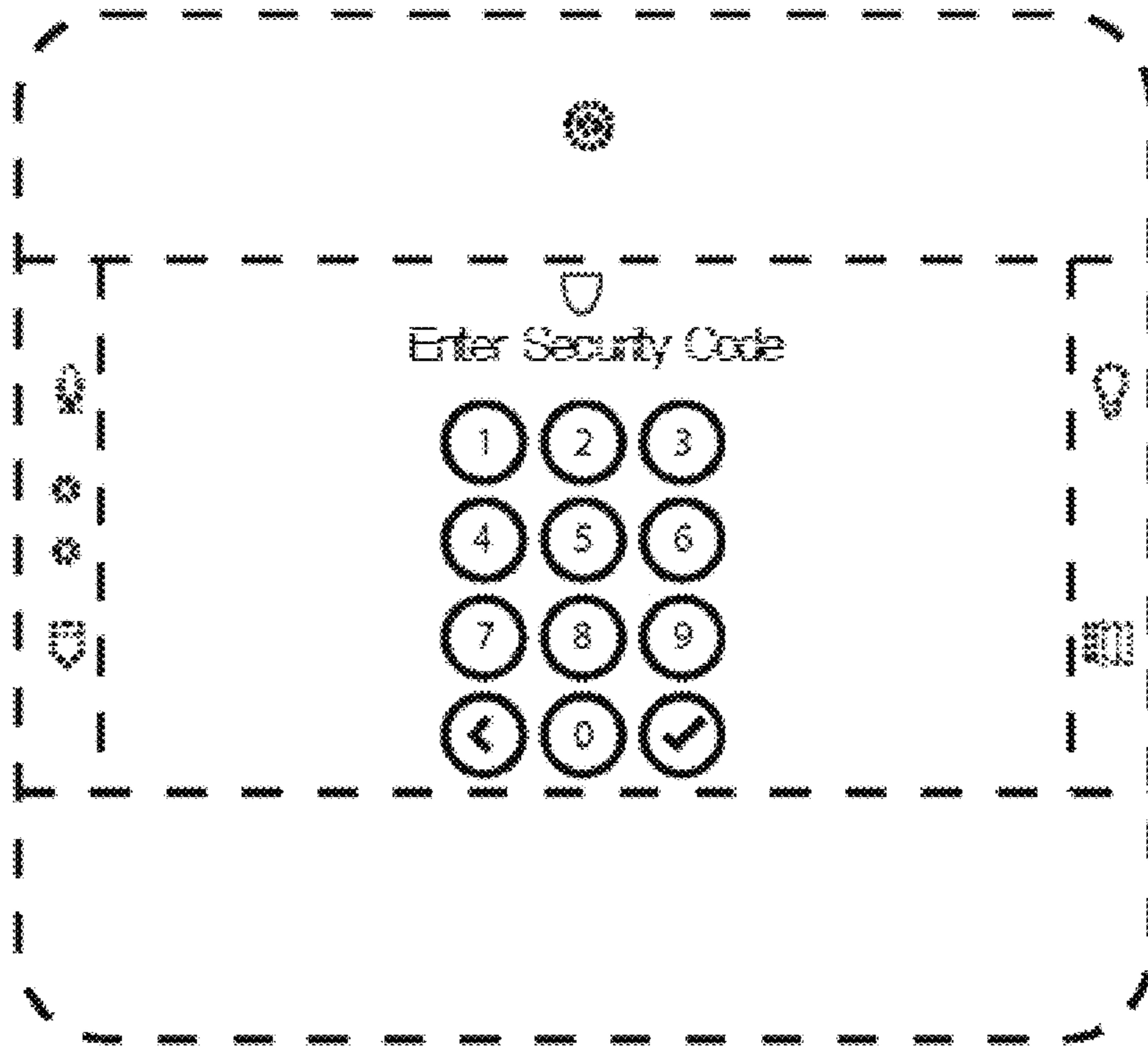

FIG. 19

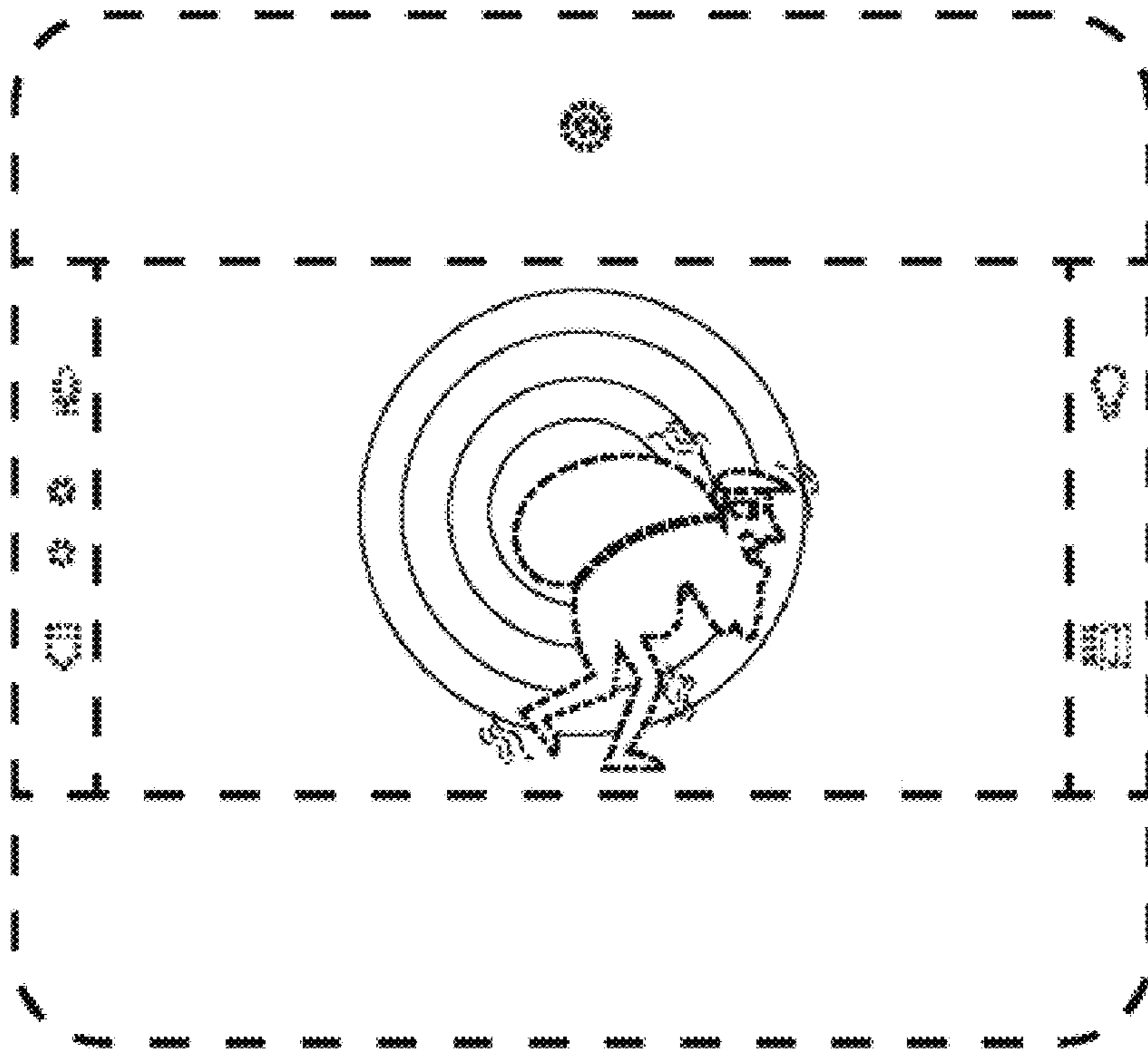

FIG. 20