



US00D826924S

(12) **United States Design Patent**
Lee et al.

(10) **Patent No.:** **US D826,924 S**
(45) **Date of Patent:** **** Aug. 28, 2018**

(54) **LAPTOP COMPUTER**

FOREIGN PATENT DOCUMENTS

(71) Applicant: **LG ELECTRONICS INC.**, Seoul
(KR)

CN 304200952 * 7/2017
WO D094404-001 * 7/2017

(72) Inventors: **Heechang Lee**, Seoul (KR); **Bumsang Lee**, Seoul (KR); **Taejin Lee**, Seoul (KR)

Primary Examiner — Barbara Fox
Assistant Examiner — Dana K Weiland

(74) *Attorney, Agent, or Firm* — Birch, Stewart, Kolasch & Birch, LLP

(73) Assignee: **LG ELECTRONICS INC.**, Seoul (KR)

(57) **CLAIM**

The ornamental design for a laptop computer, as shown and described.

(**) Term: **15 Years**

DESCRIPTION

(21) Appl. No.: **35/503,346**

(22) Filed: **Jan. 13, 2017**

(80) **Hague Agreement Data**

Int. Filing Date: **Jan. 13, 2017**

Int. Reg. No.: **DM/094404**

Int. Reg. Date: **Jan. 13, 2017**

Int. Reg. Pub. Date: **Jul. 14, 2017**

(30) **Foreign Application Priority Data**

Jul. 20, 2016 (KR) 30-2016-0035500

(51) **LOC (11) Cl.** **14-02**

(52) **U.S. Cl.**
USPC **D14/315**

(58) **Field of Classification Search**

USPC D14/341-347, 315-327, 420, 426,
D14/129-130, 496, 138 G, 138 R,
D14/138 AA, 138 AB; D18/1, 2, 11
(Continued)

(56) **References Cited**

U.S. PATENT DOCUMENTS

D580,433 S * 11/2008 Chiang D14/345

D588,126 S * 3/2009 Chiang D14/345

(Continued)

1. Laptop computer

1.1 is a front perspective view of a laptop computer showing the new design in a closed configuration;

1.2 is a front view thereof;

1.3 is a back view thereof;

1.4 is a left view thereof;

1.5 is a right view thereof;

1.6 is a top view thereof;

1.7 is a bottom view thereof;

1.8 is another front perspective view of the laptop computer, shown in an open configuration;

1.9 is a front view thereof;

1.10 is a back view thereof;

1.11 is a left view thereof;

1.12 is a right view thereof;

1.13 is a top view thereof;

1.14 is a bottom view thereof.

1.15 is another front perspective view of the laptop computer, shown in an alternate open configuration;

1.16 is a front view thereof;

1.17 is a back view thereof;

1.18 is a left view thereof;

1.19 is a right view thereof;

1.20 is a top view thereof;

1.21 is a bottom view thereof.

1.22 is another front perspective view of the laptop computer, shown in another alternate open configuration;

1.23 is a front view thereof;

1.24 is a back view thereof;

(Continued)

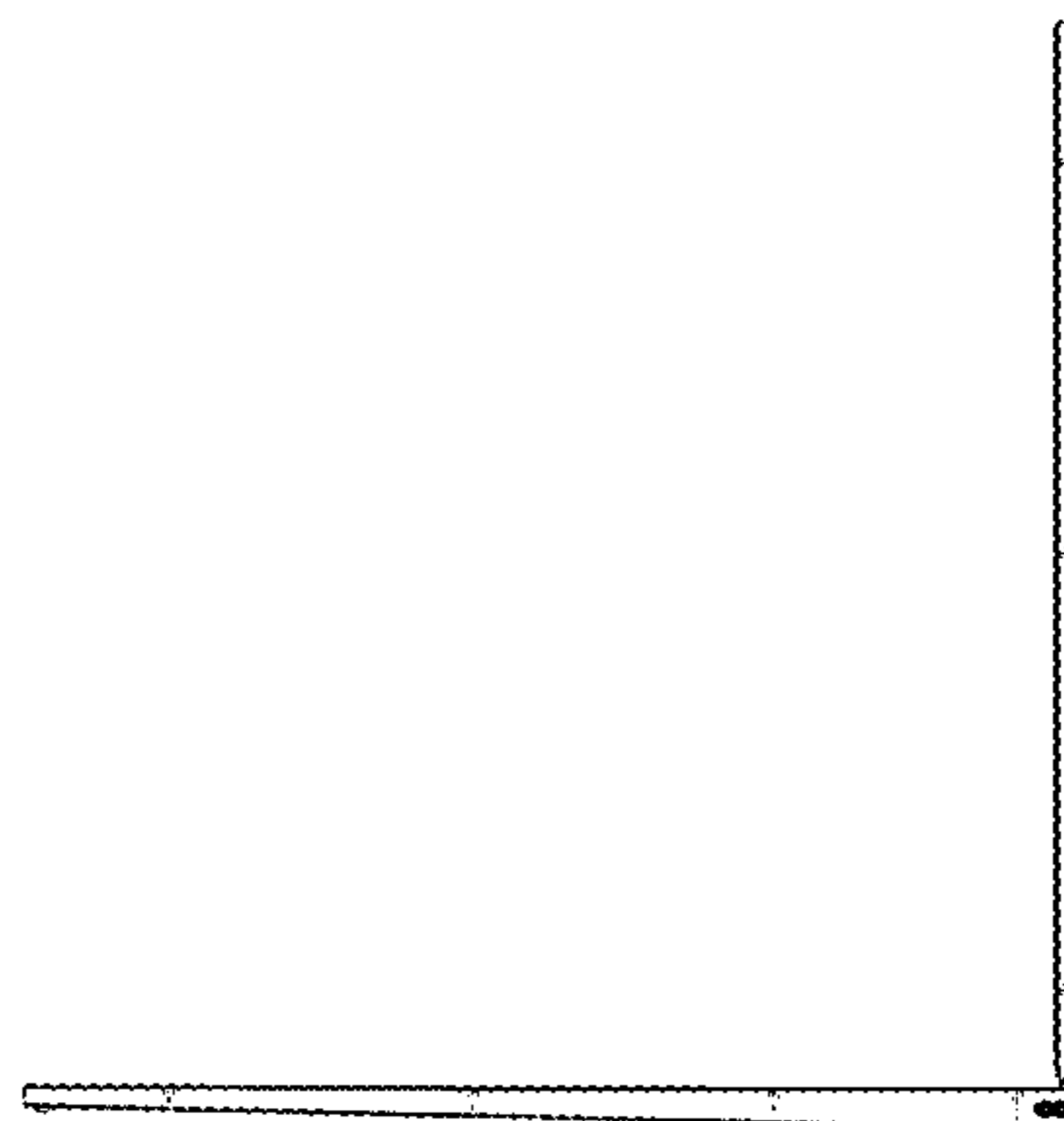
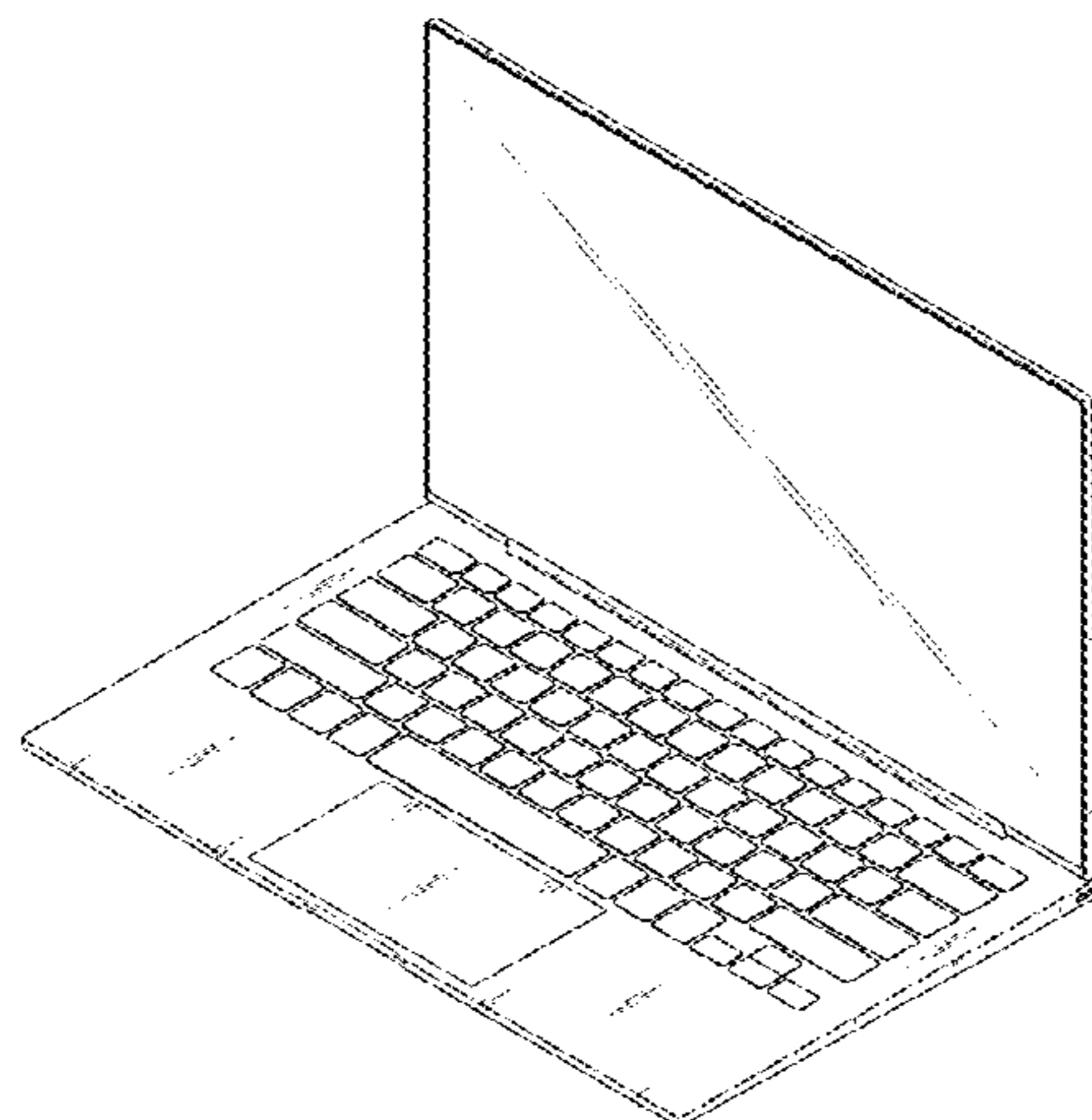

1.25 is a left view thereof;
 1.26 is a right view thereof;
 1.27 is a top view thereof; and,
 1.28 is a bottom view thereof.

1 Claim, 28 Drawing Sheets

(58) **Field of Classification Search**

CPC G06F 1/16; G06F 1/1616; G06F 1/1626;
 G06F 1/1632; G06F 1/1613; G06F
 1/1601; G06F 1/1618; G06F 1/162; G06F
 1/166; G06F 1/1654; G06F 1/1681; G06F
 1/1637; G06F 1/1688; G06F 1/1656;
 G09G 5/00; F16M 11/10; H05K 5/00;
 H04M 1/0237

See application file for complete search history.

(56)

References Cited

U.S. PATENT DOCUMENTS

D626,124	S	*	10/2010	Chyan	D14/341
D631,472	S	*	1/2011	Kawase	D14/327
D665,388	S	*	8/2012	Li	D14/327
D671,536	S	*	11/2012	Fukusawa	D14/315
D717,296	S	*	11/2014	Oh	D14/316
D754,657	S	*	4/2016	Kim	D14/345
D761,249	S	*	7/2016	Liang	D14/315
D767,525	S	*	9/2016	Byun	D14/138 AB
D800,112	S	*	10/2017	Park	D14/345
D807,875	S	*	1/2018	Senatori	D14/316
D808,951	S	*	1/2018	Jung	D14/316
D813,859	S	*	3/2018	Oakley	D14/315
2013/0214661	A1	*	8/2013	McBroom	G06F 1/1667 312/325
2015/0378397	A1	*	12/2015	Park	G06F 1/1652 361/679.27

* cited by examiner

1.1

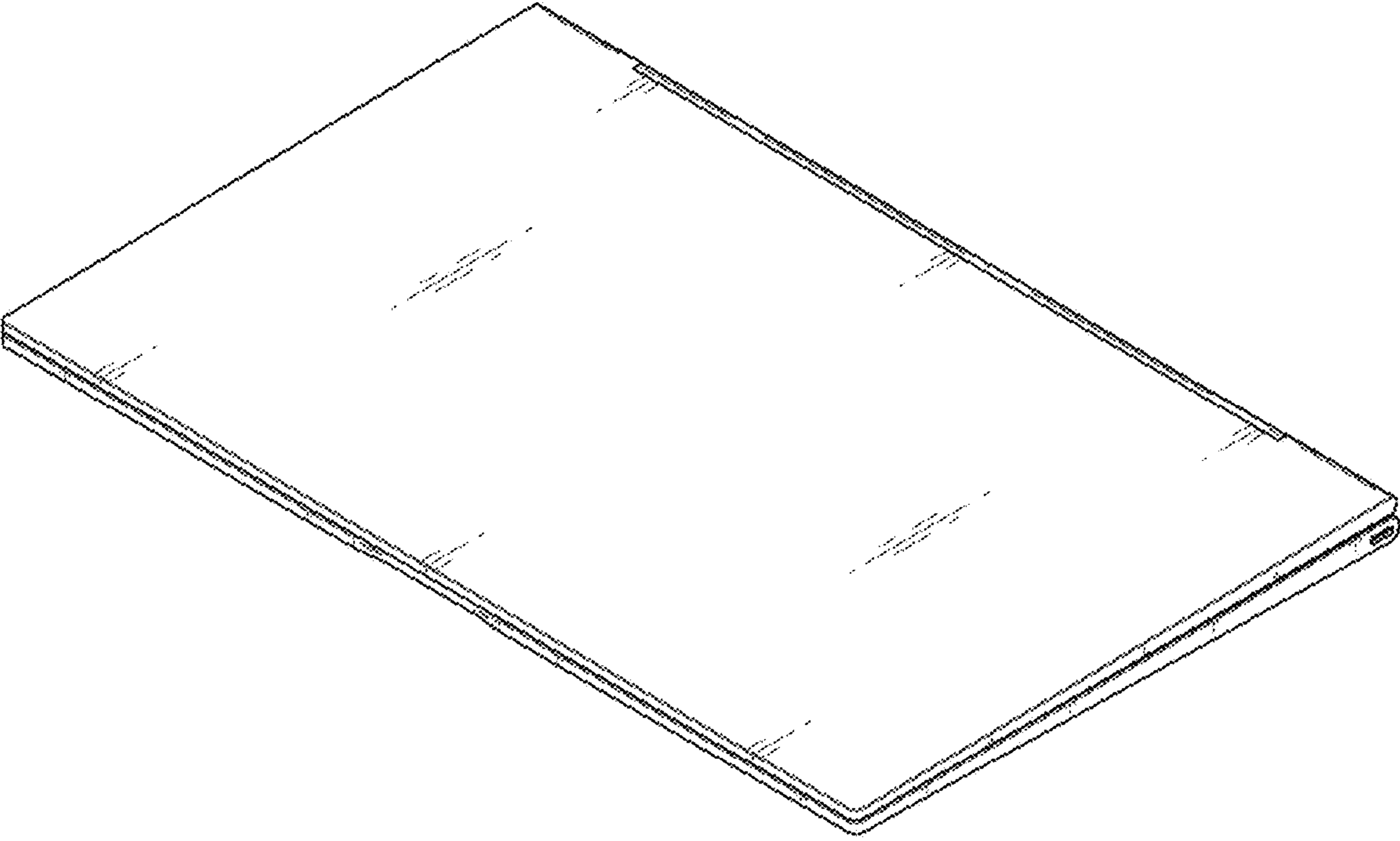

1.2

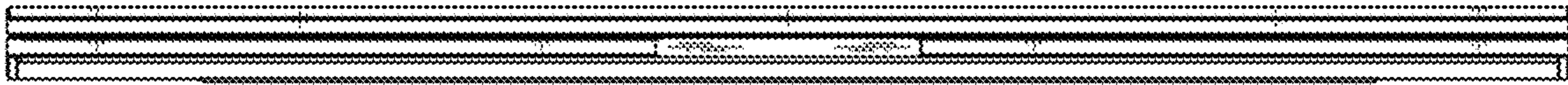

1.3



1.4



1.5



1.6

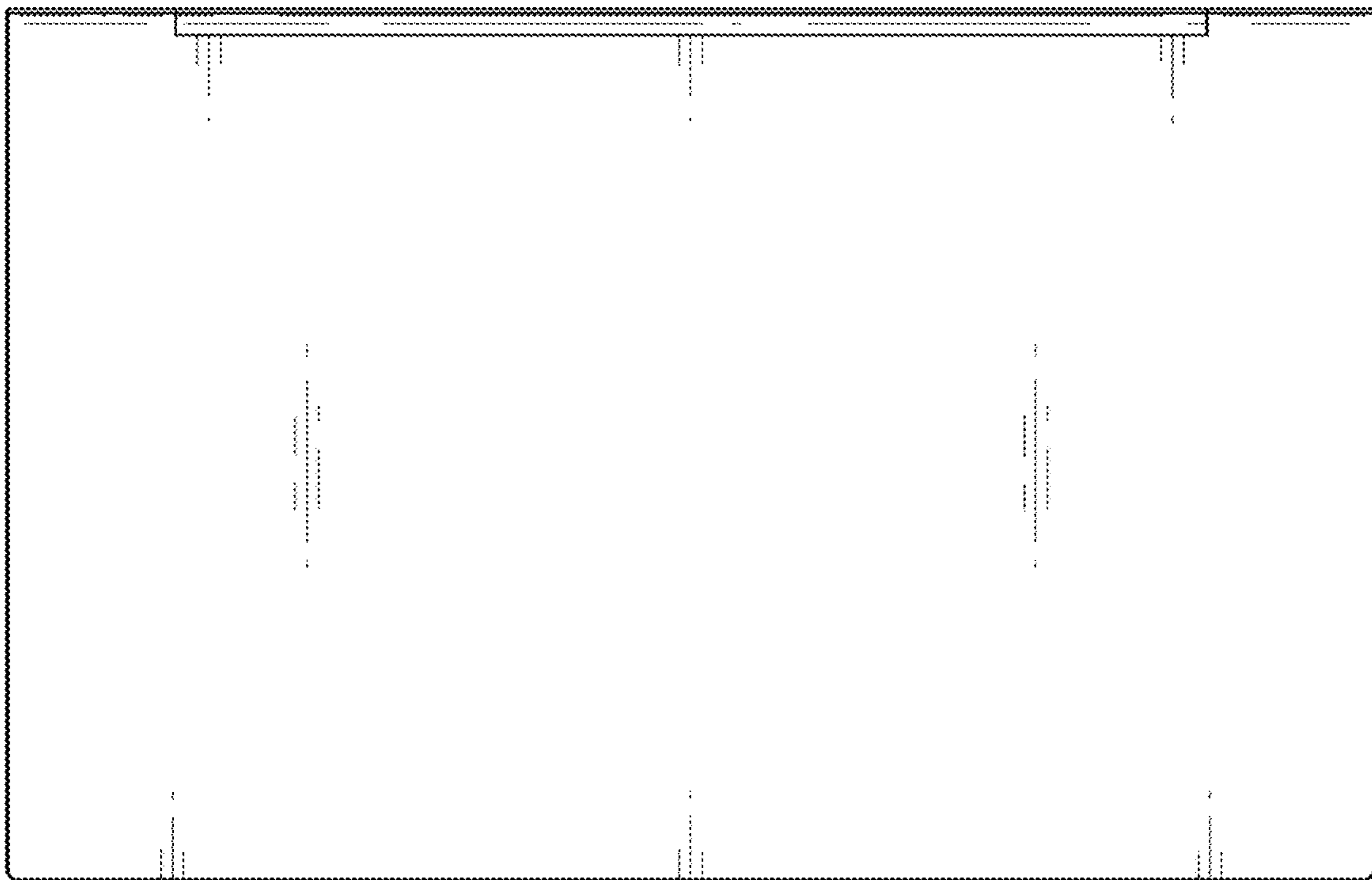

1.7

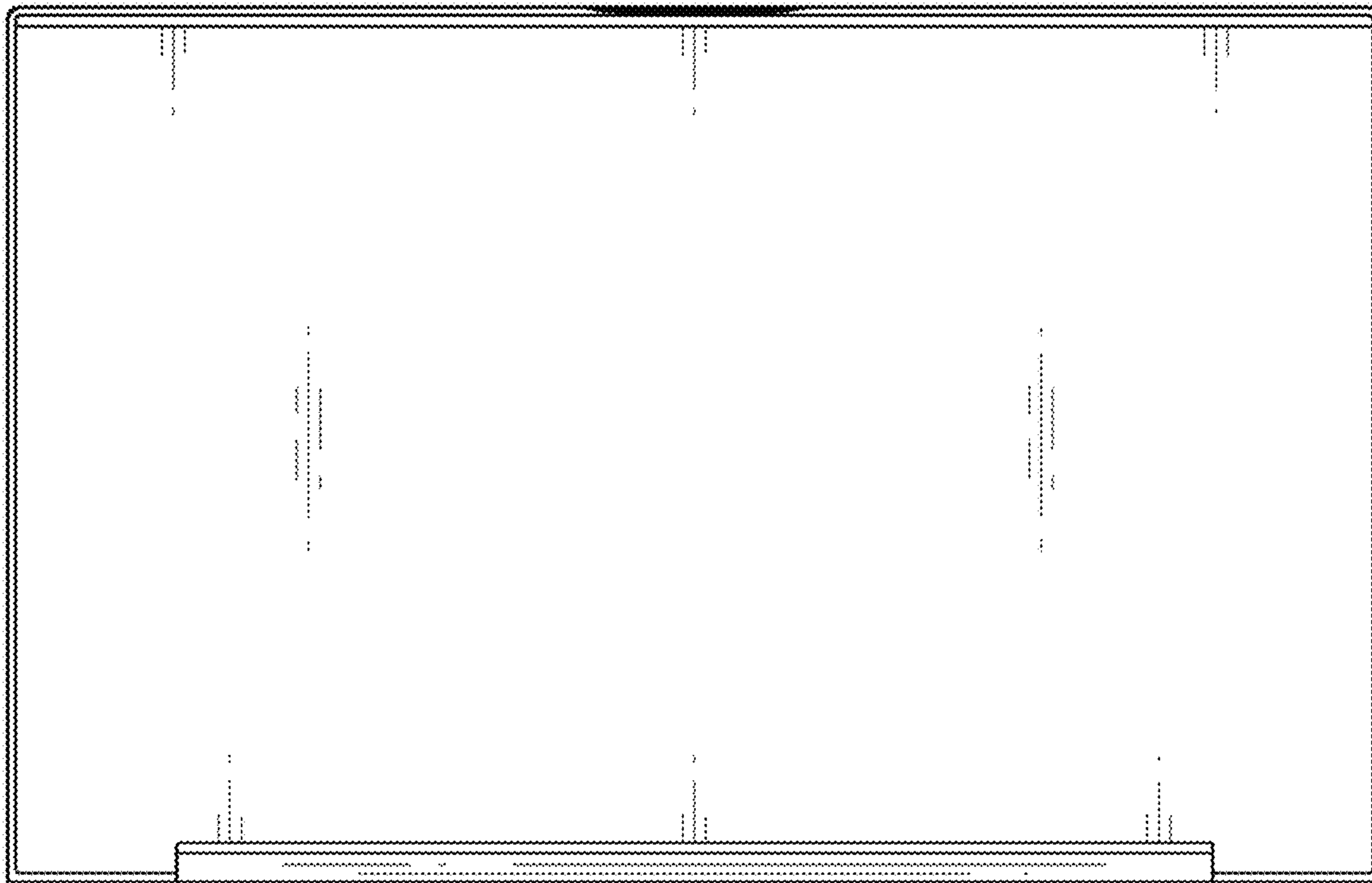

1.8

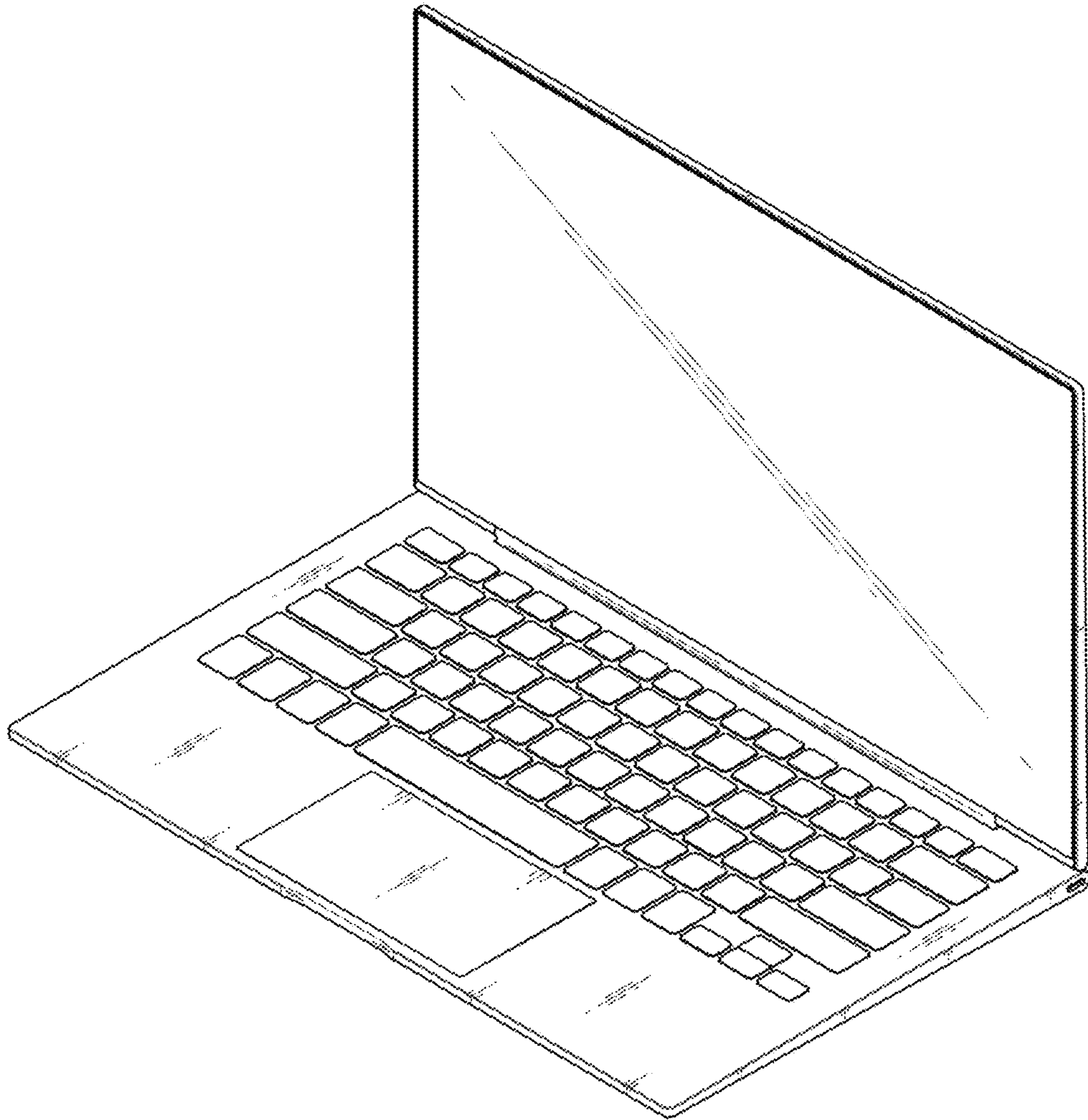

1.9

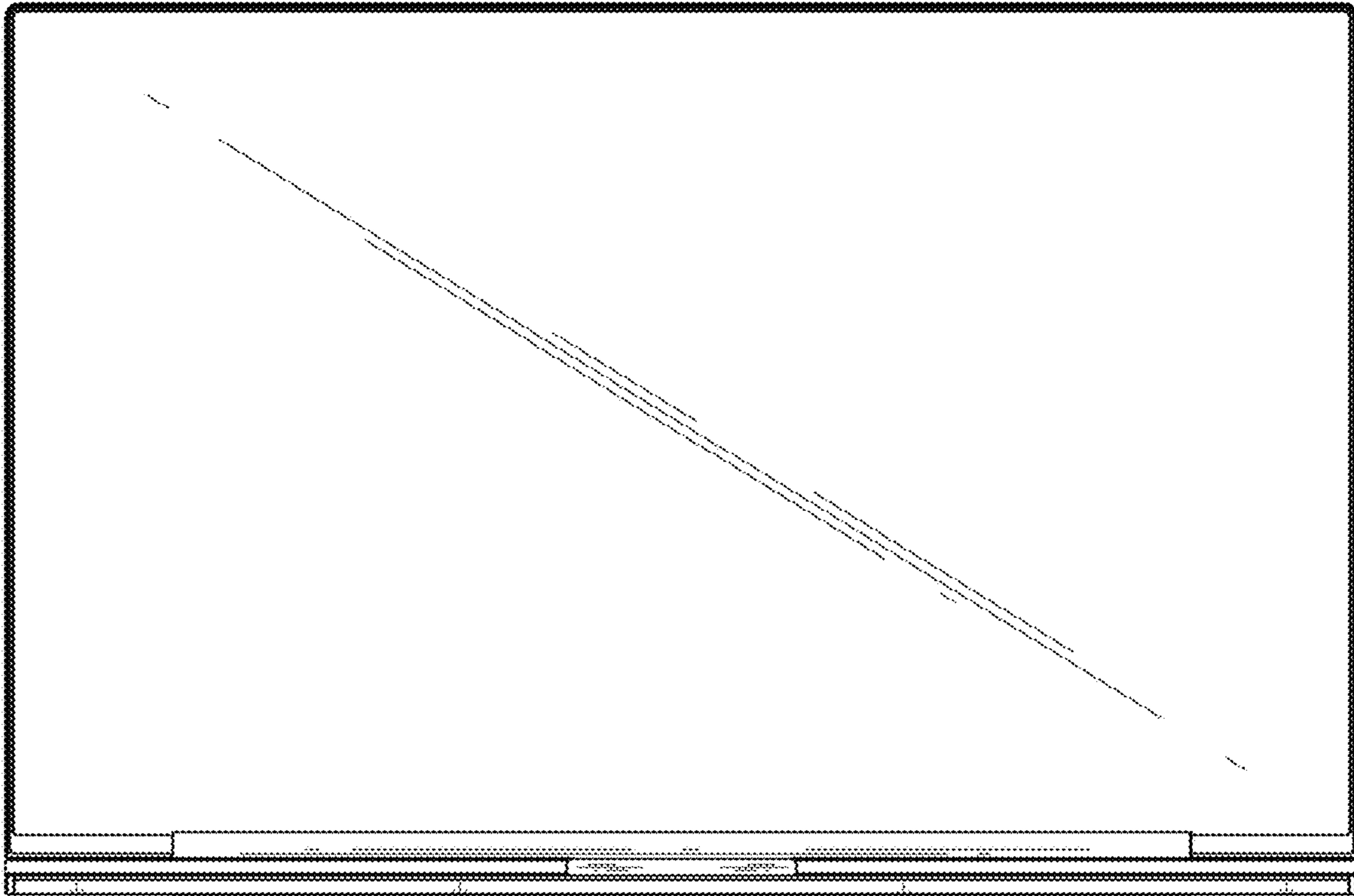

1.10

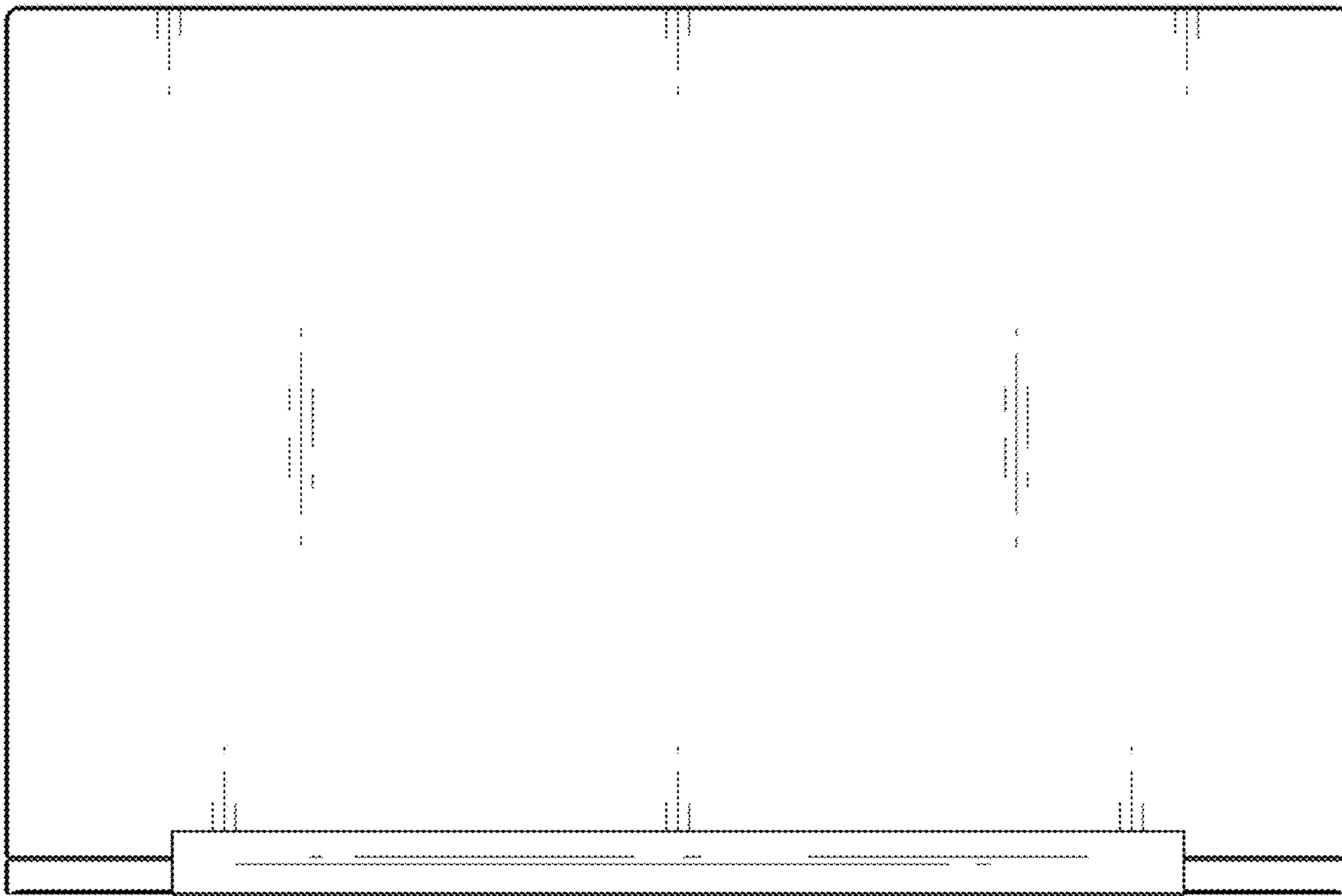

1.11

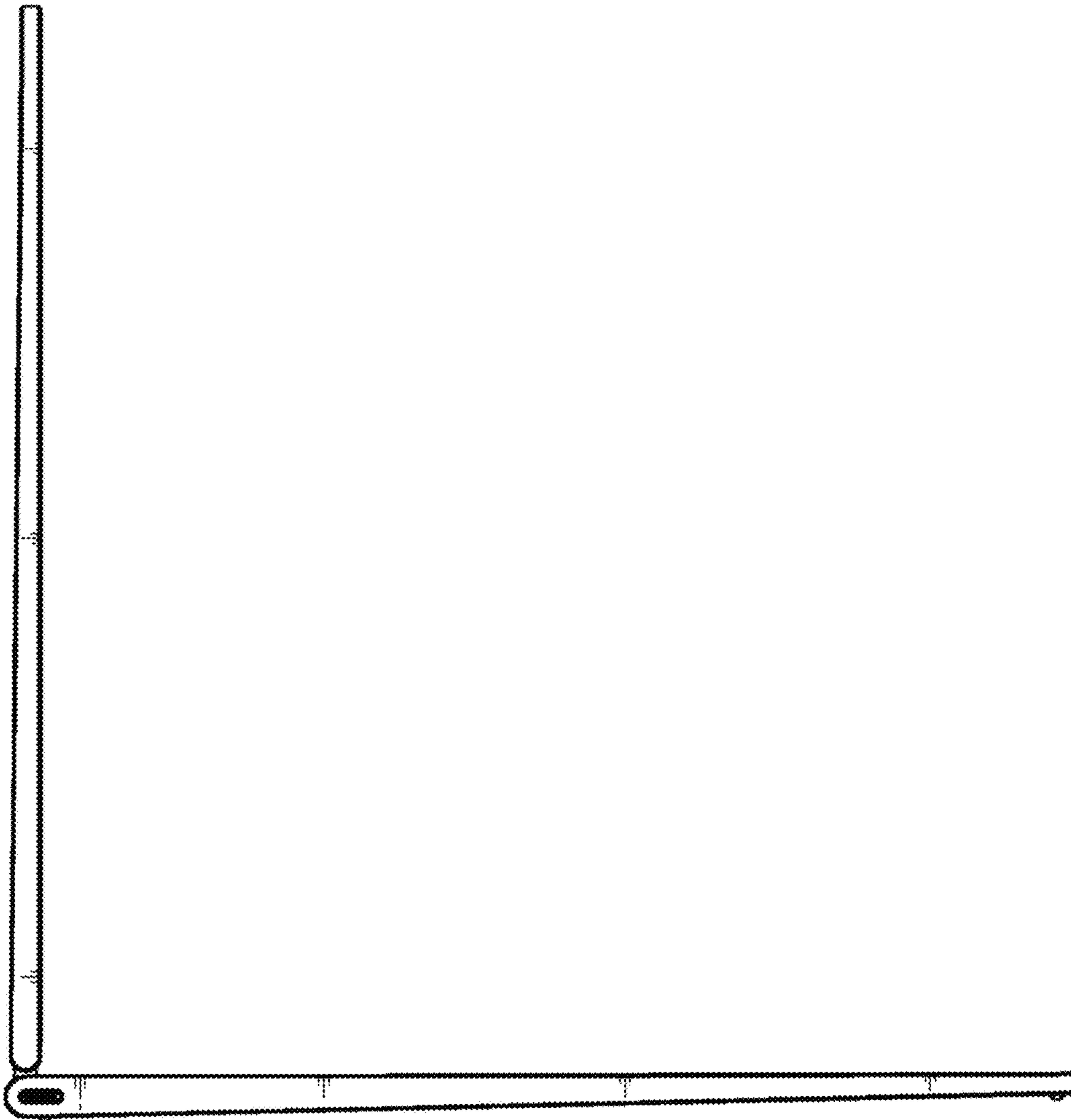

1.12

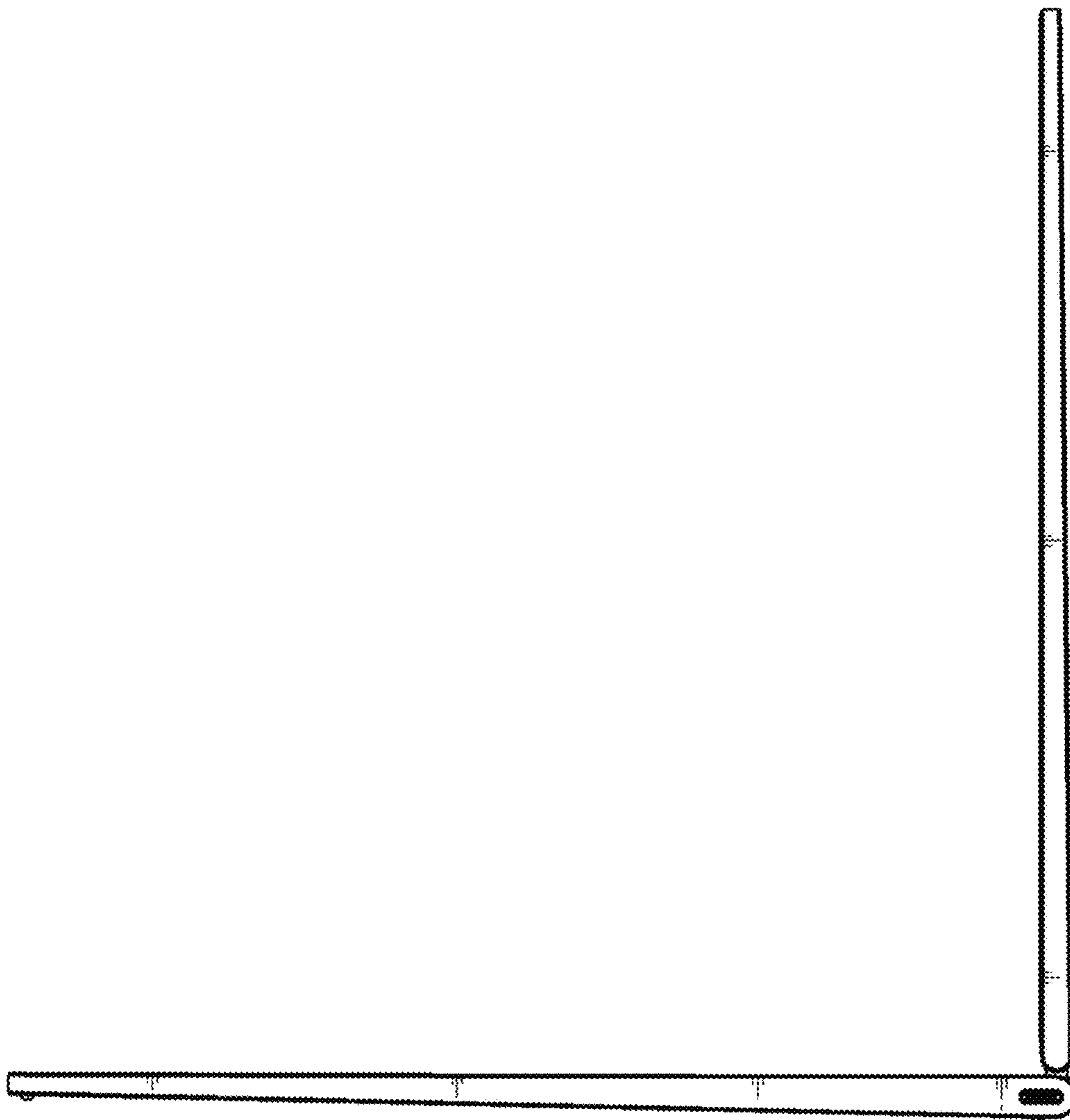

1.13

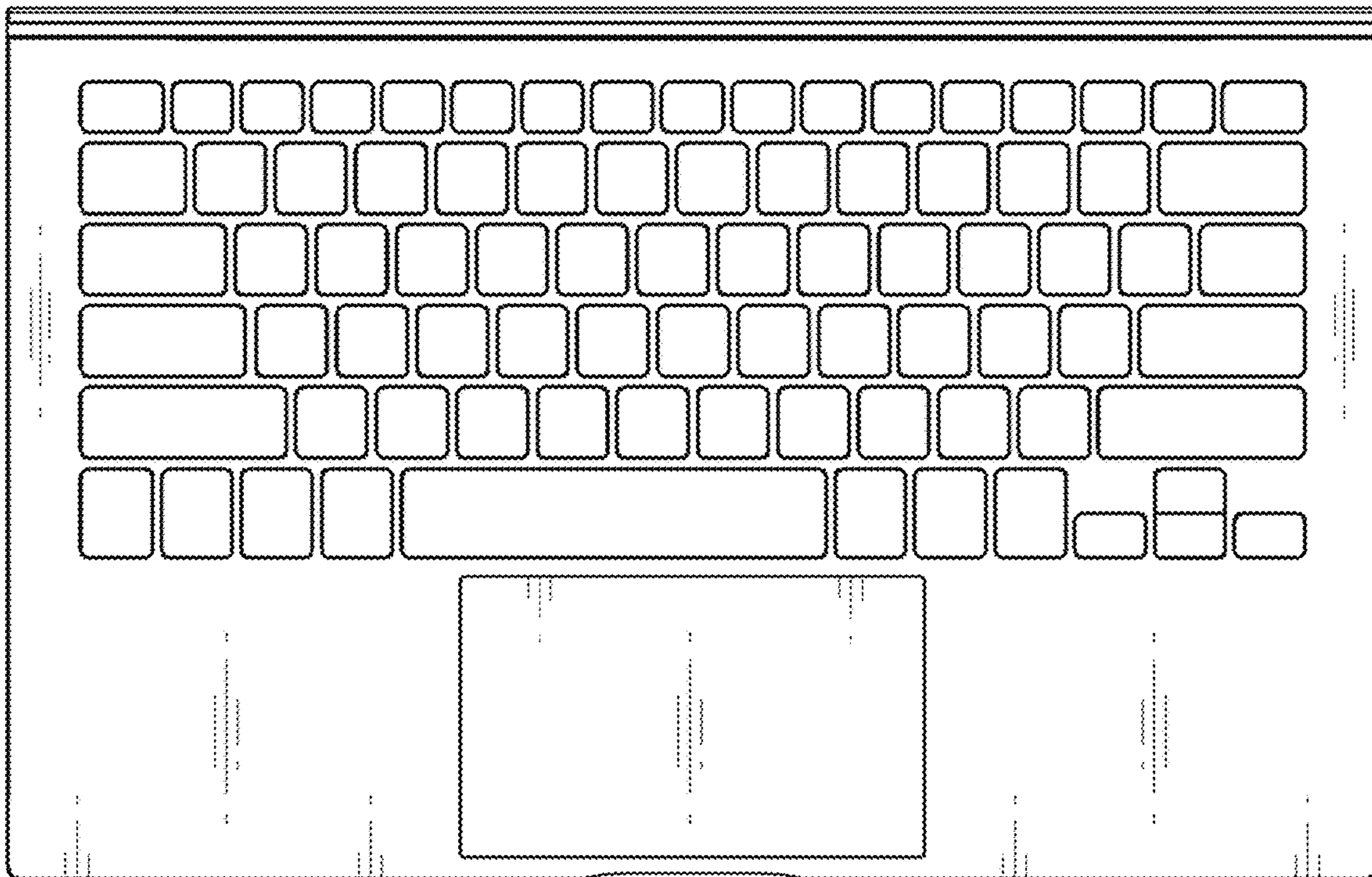

1.14

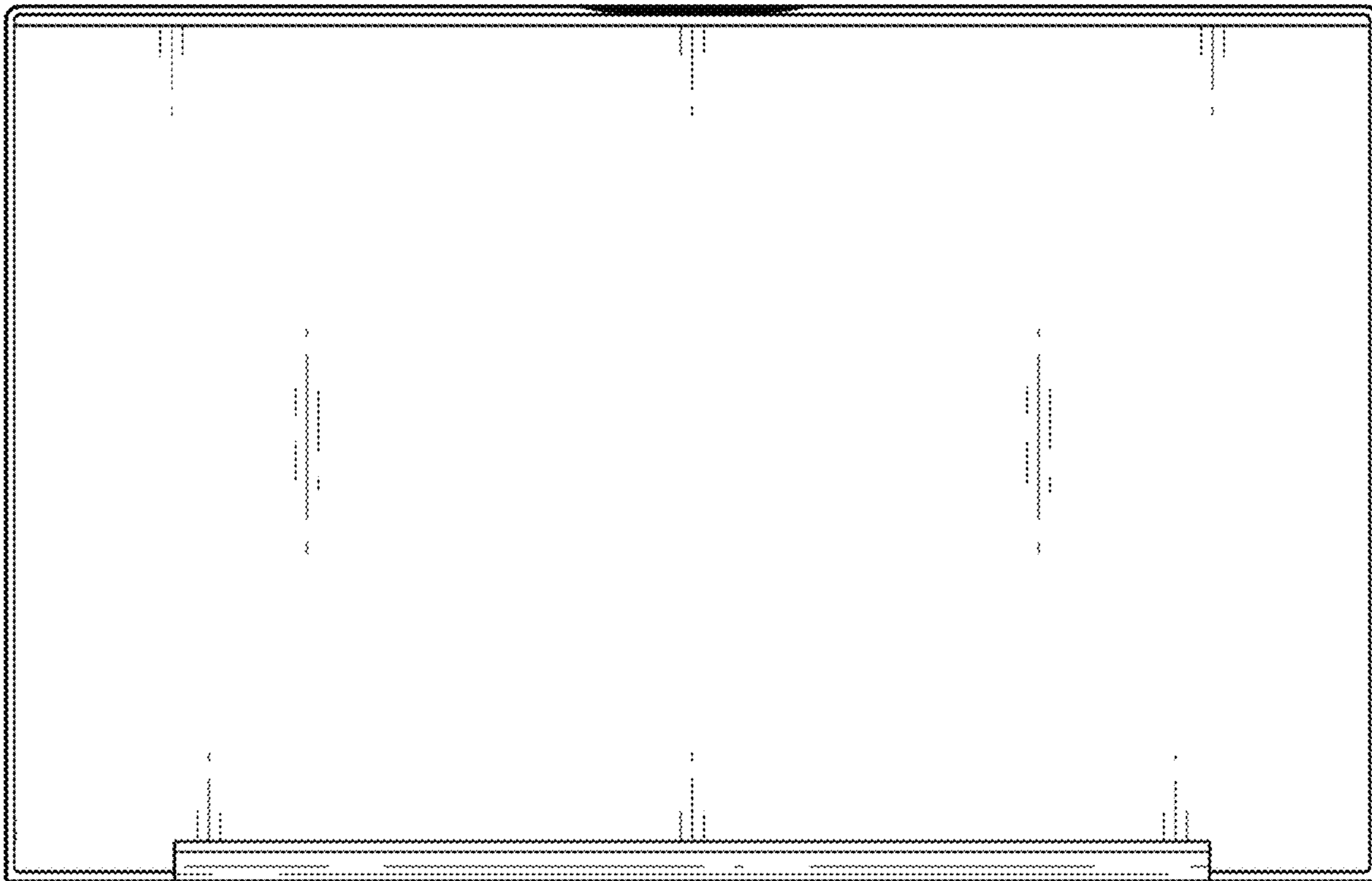

1.15

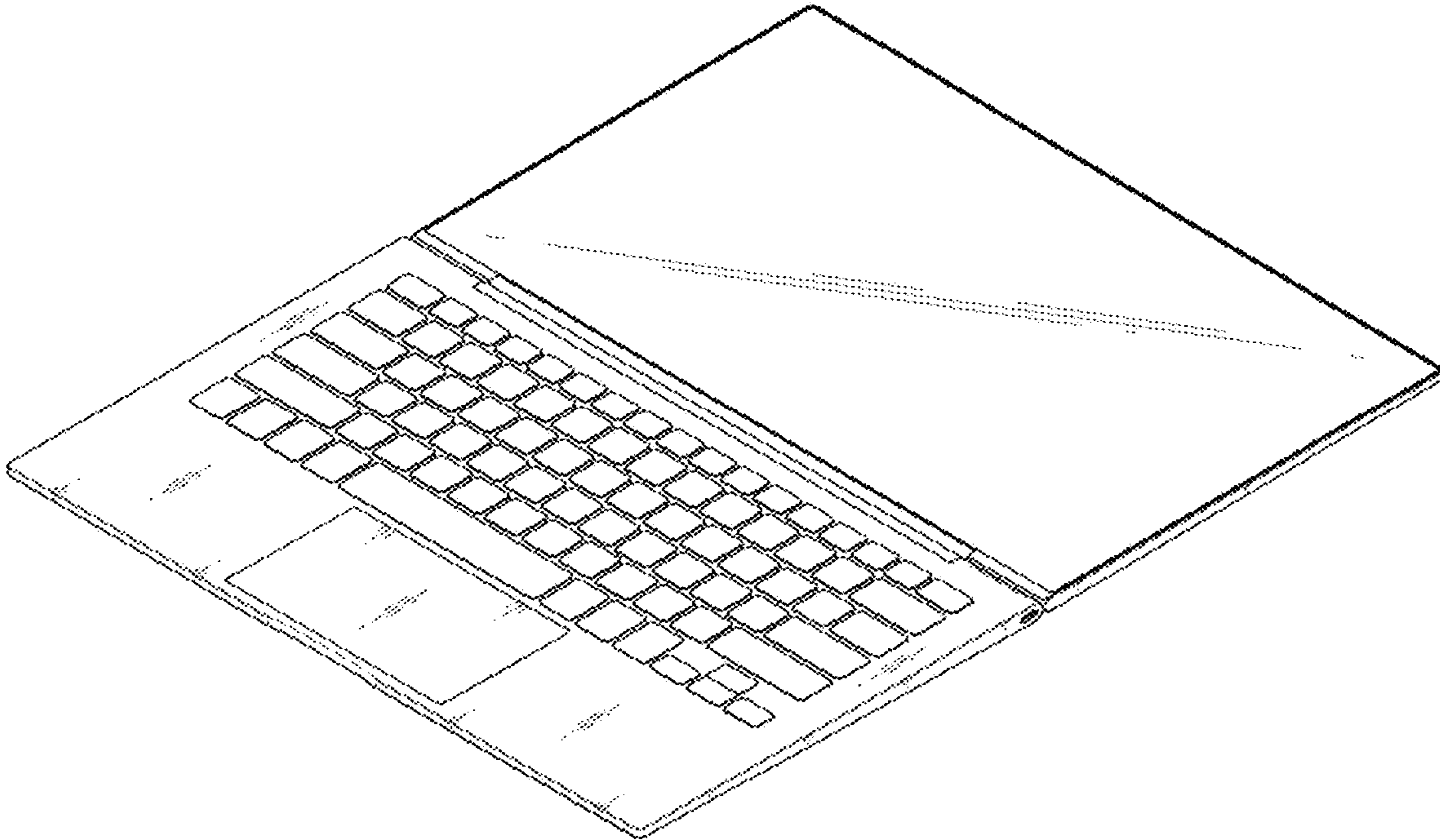

1.16

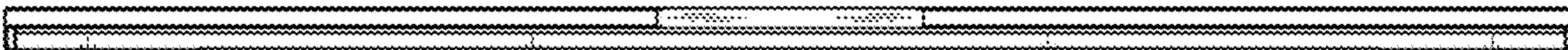

1.17



1.18



1.19



1.20

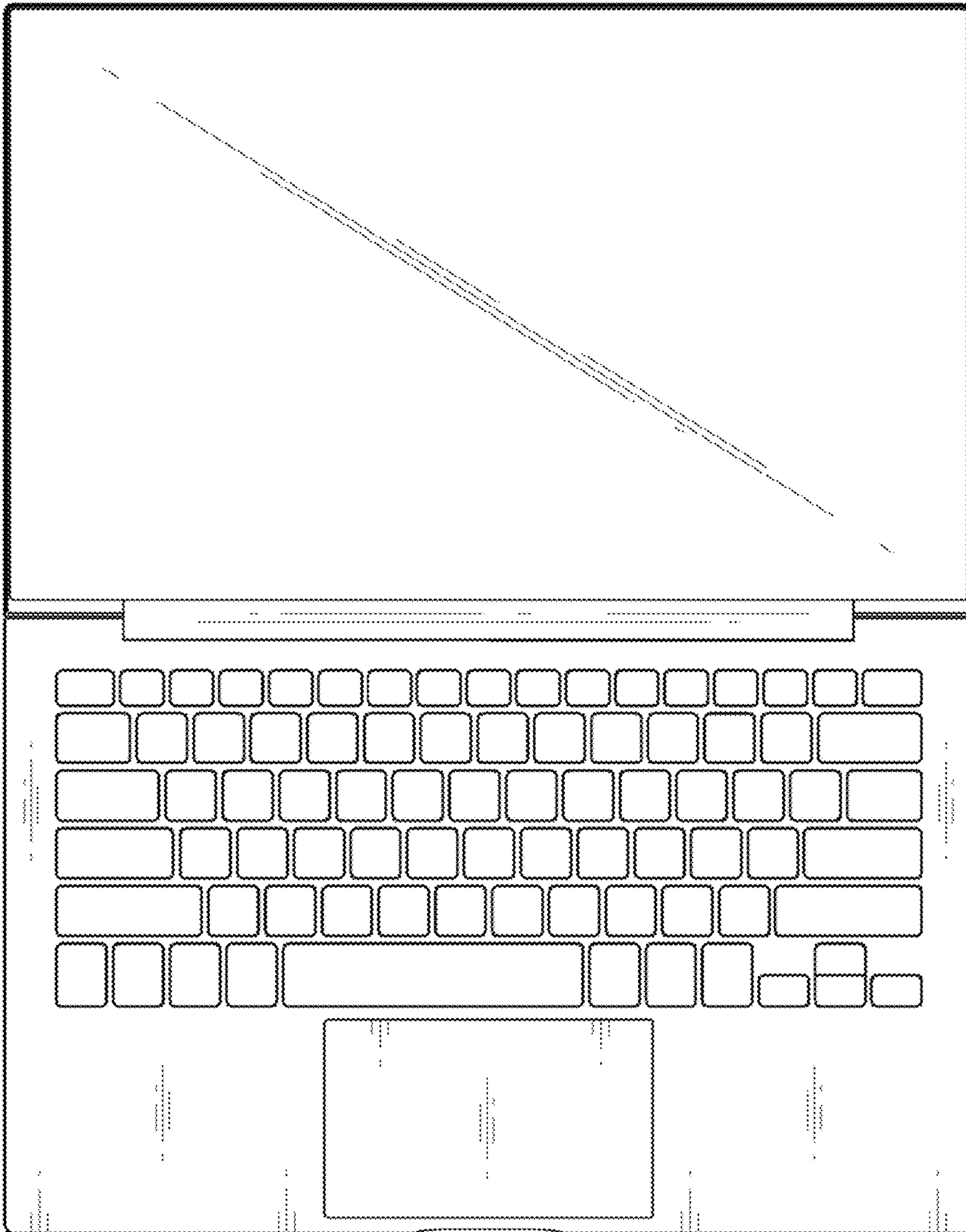

1.21

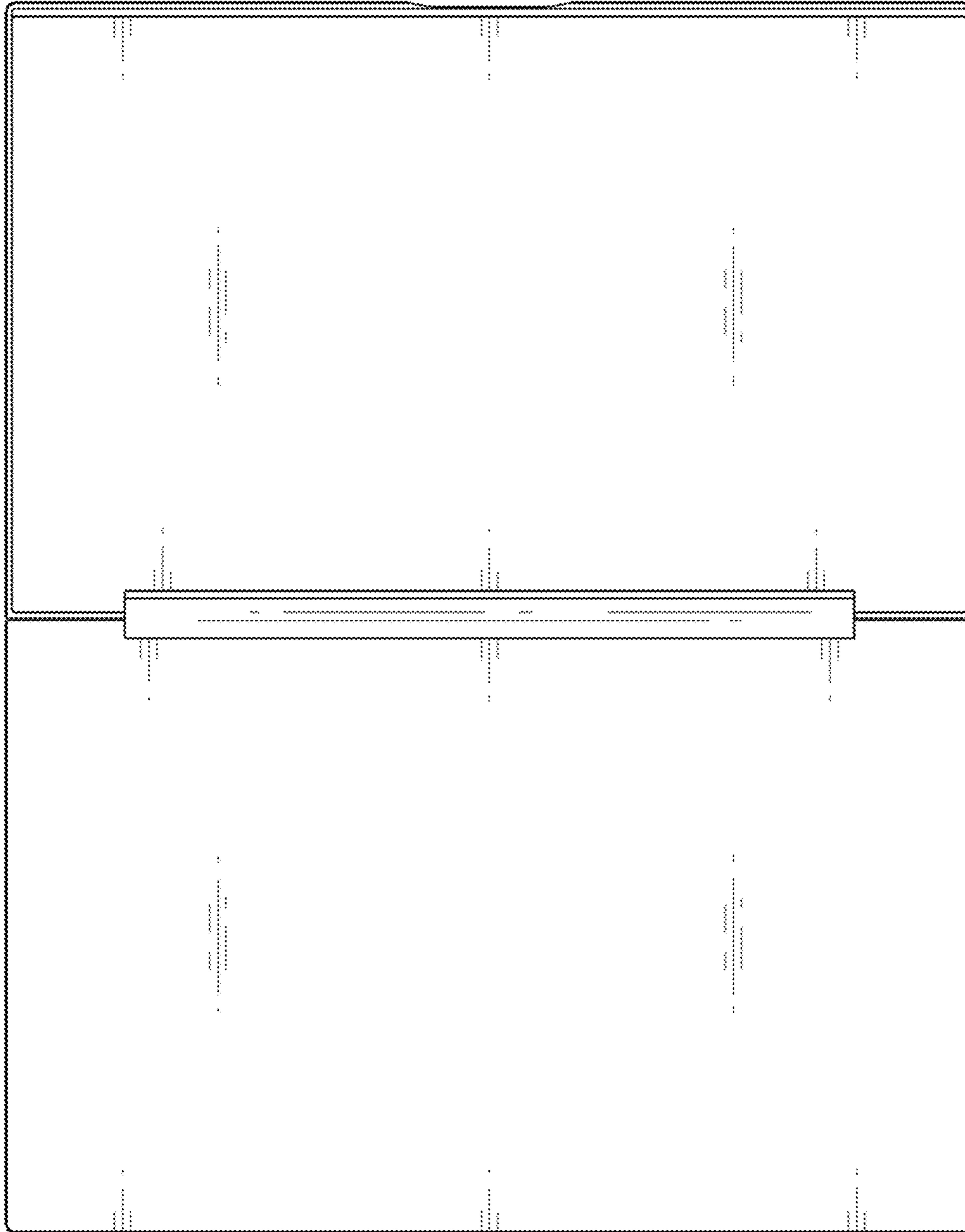

1.22

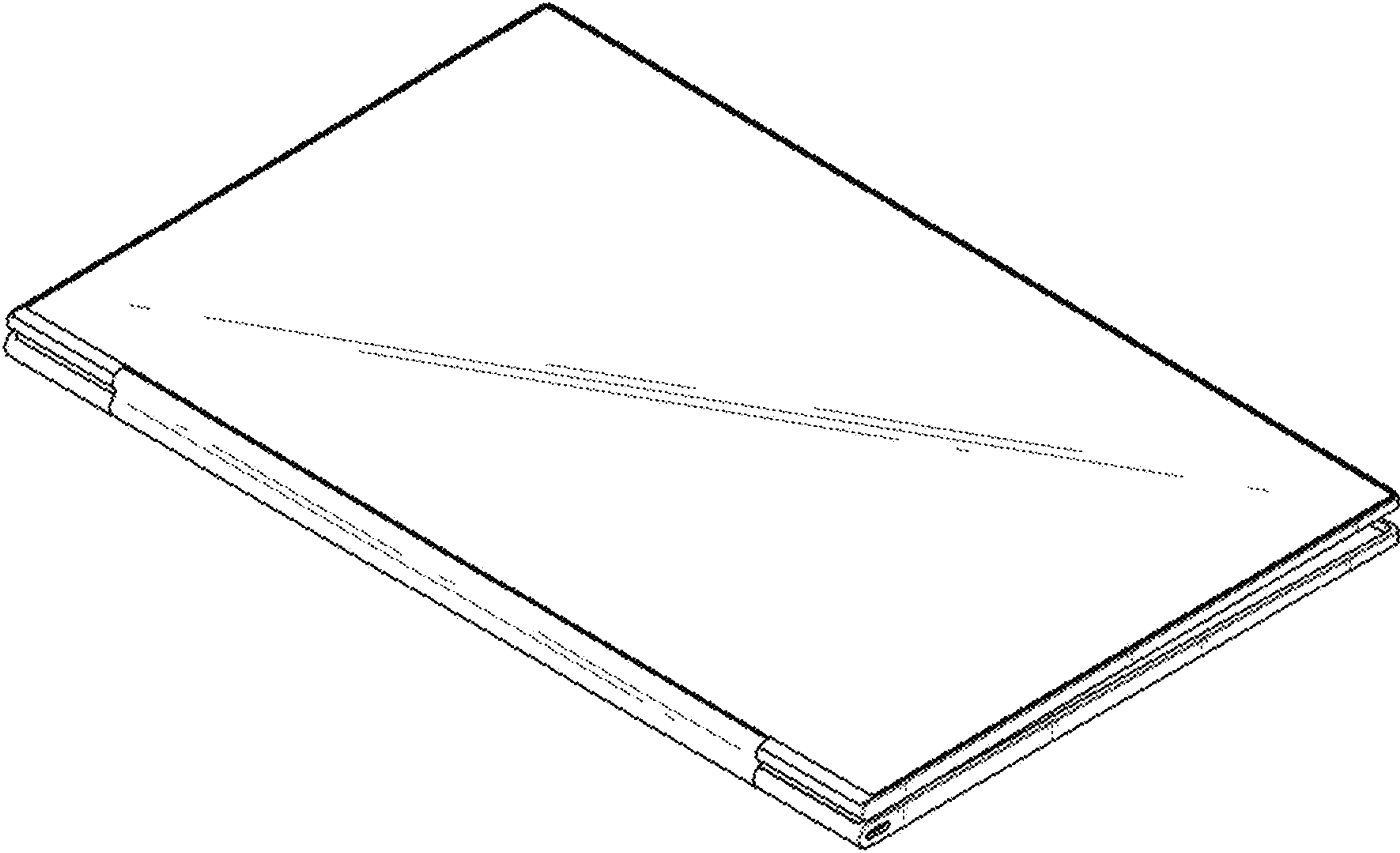

1.23

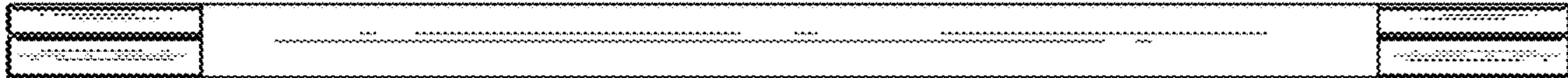

1.24



1.25



1.26

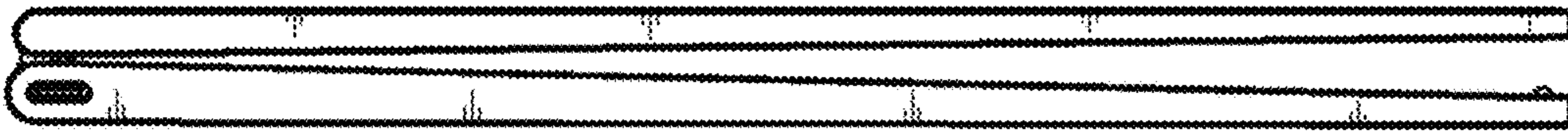

1.27

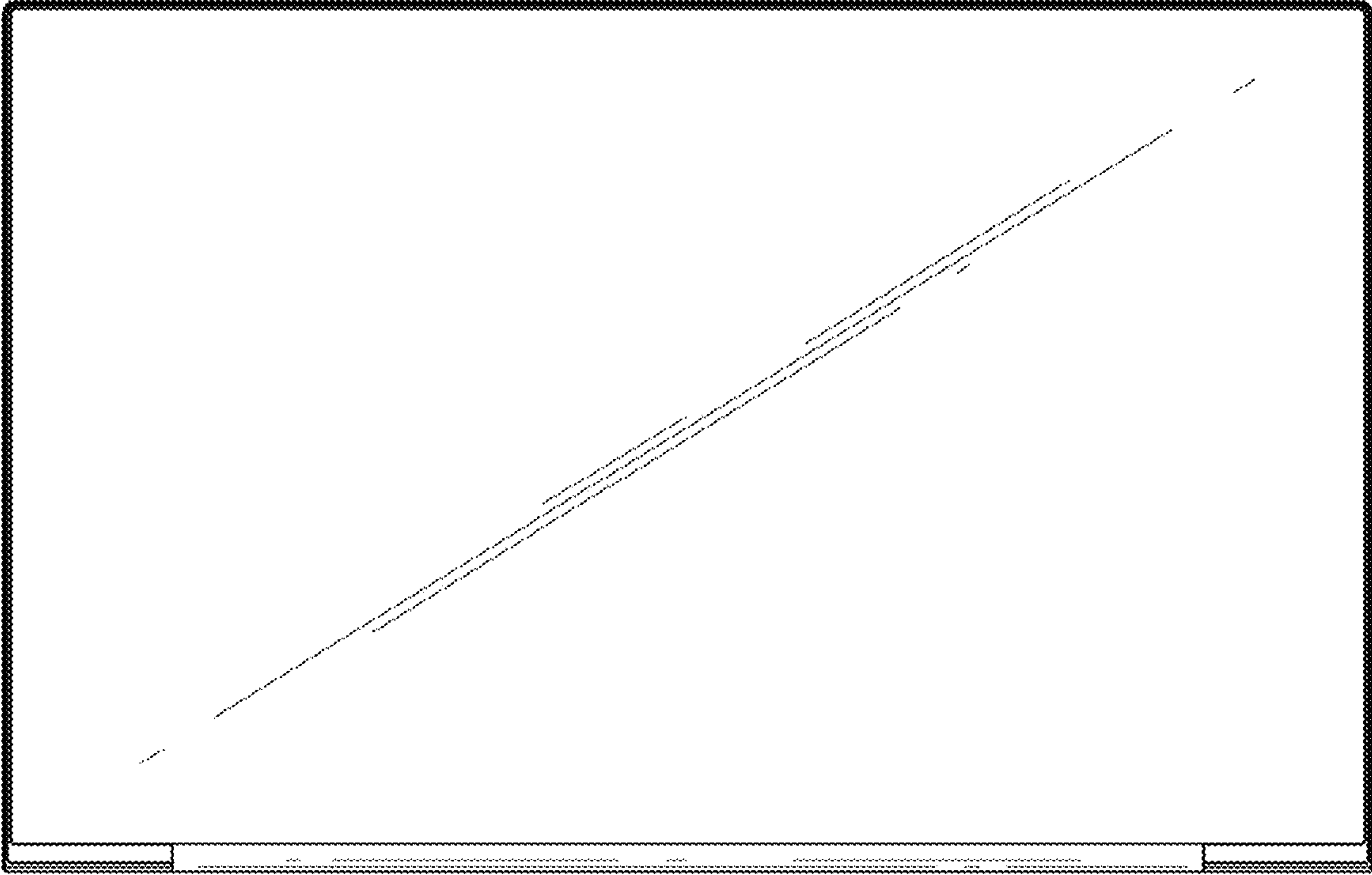

1.28

