

US00D826780S

(12) **United States Design Patent**  
**Shaddox**

(10) **Patent No.:** **US D826,780 S**

(45) **Date of Patent:** **\*\* Aug. 28, 2018**

(54) **VEHICLE**

(71) Applicant: **Neil H. Shaddox**, Hamtramck, MI (US)

(72) Inventor: **Neil H. Shaddox**, Hamtramck, MI (US)

(\*\*) Term: **15 Years**

(21) Appl. No.: **29/593,632**

(22) Filed: **Feb. 10, 2017**

(51) **LOC (11) Cl.** ..... **12-08**

(52) **U.S. Cl.**  
USPC ..... **D12/86**

(58) **Field of Classification Search**  
USPC ..... D12/86, 90–92, 88, 164, 83; D21/421,  
D21/433, 434, 533–535; 296/181.1,  
296/181.5  
CPC ..... B62D 35/00; B62D 25/00; B62D 25/06;  
B62D 33/00  
See application file for complete search history.

(56) **References Cited**

**U.S. PATENT DOCUMENTS**

D352,972 S \* 11/1994 Chiang ..... D21/533  
D399,789 S \* 10/1998 Adamovich ..... D12/86

D770,329 S \* 11/2016 Ishida ..... D12/86  
D792,524 S \* 7/2017 Lee ..... D21/533  
D810,210 S \* 2/2018 Lee ..... D21/533  
D810,627 S \* 2/2018 Cloke ..... D12/92

\* cited by examiner

*Primary Examiner* — Melody N Brown

(74) *Attorney, Agent, or Firm* — Winstead PC

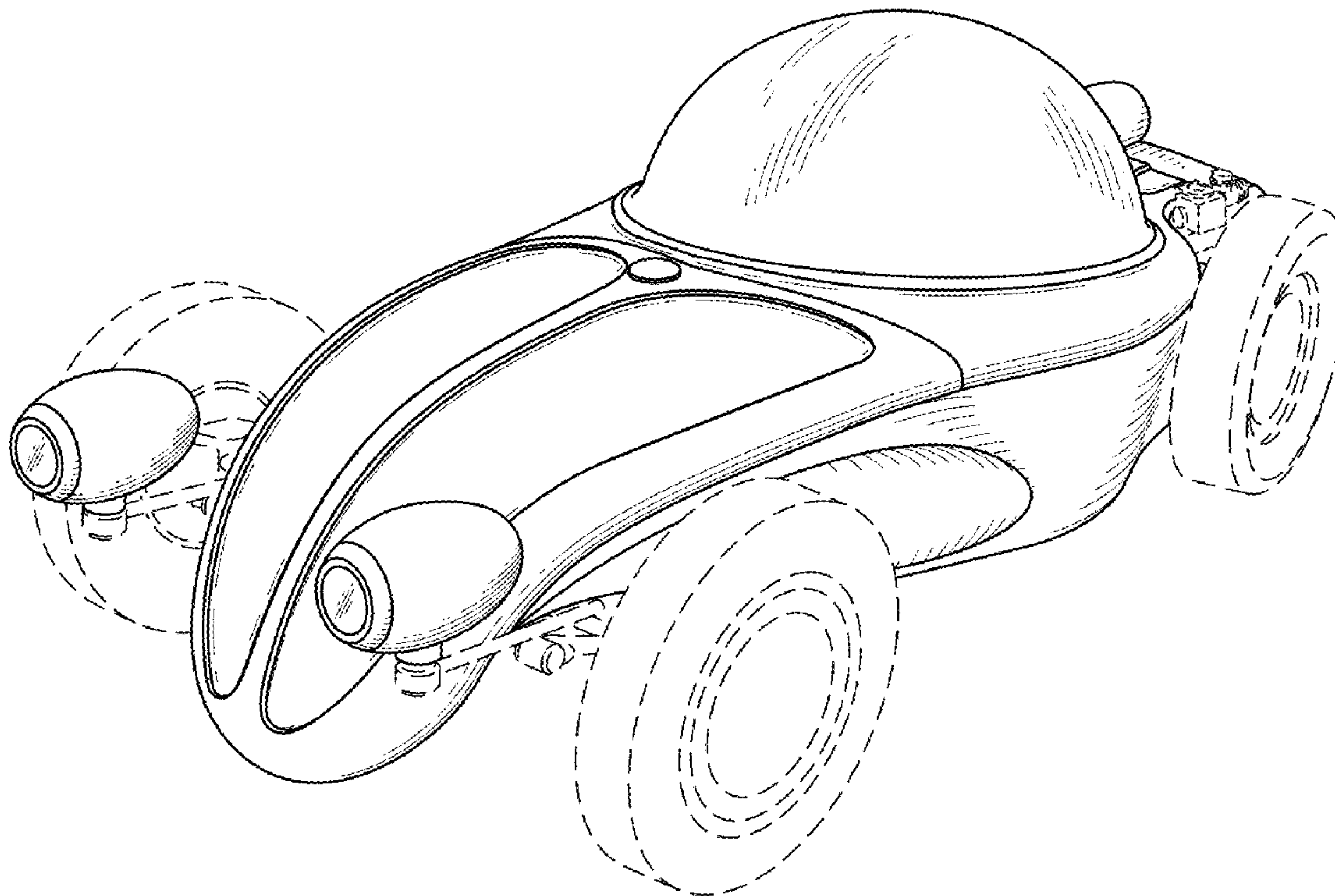
(57) **CLAIM**

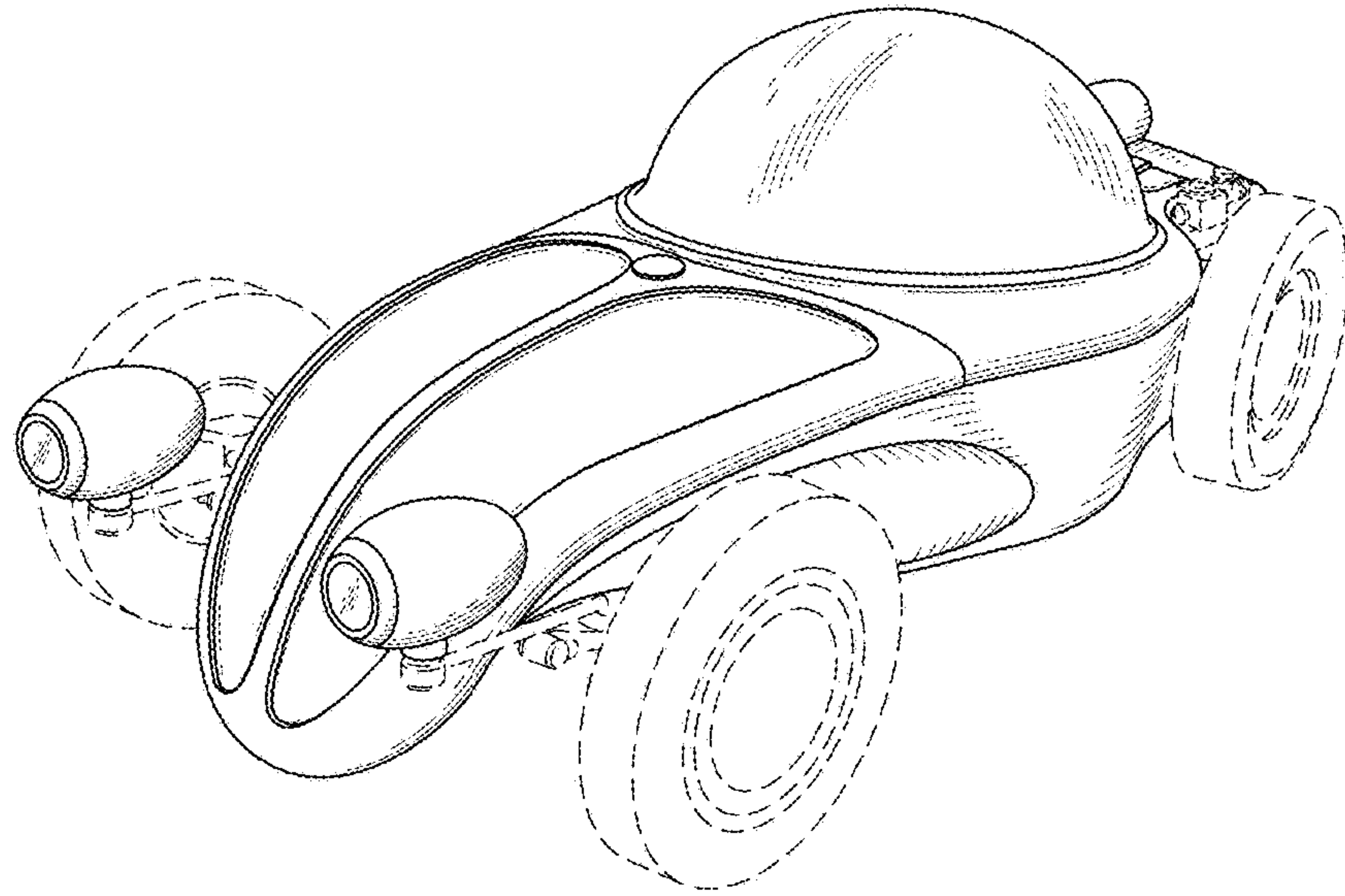
I claim the ornamental design for a vehicle, as shown and described.

**DESCRIPTION**

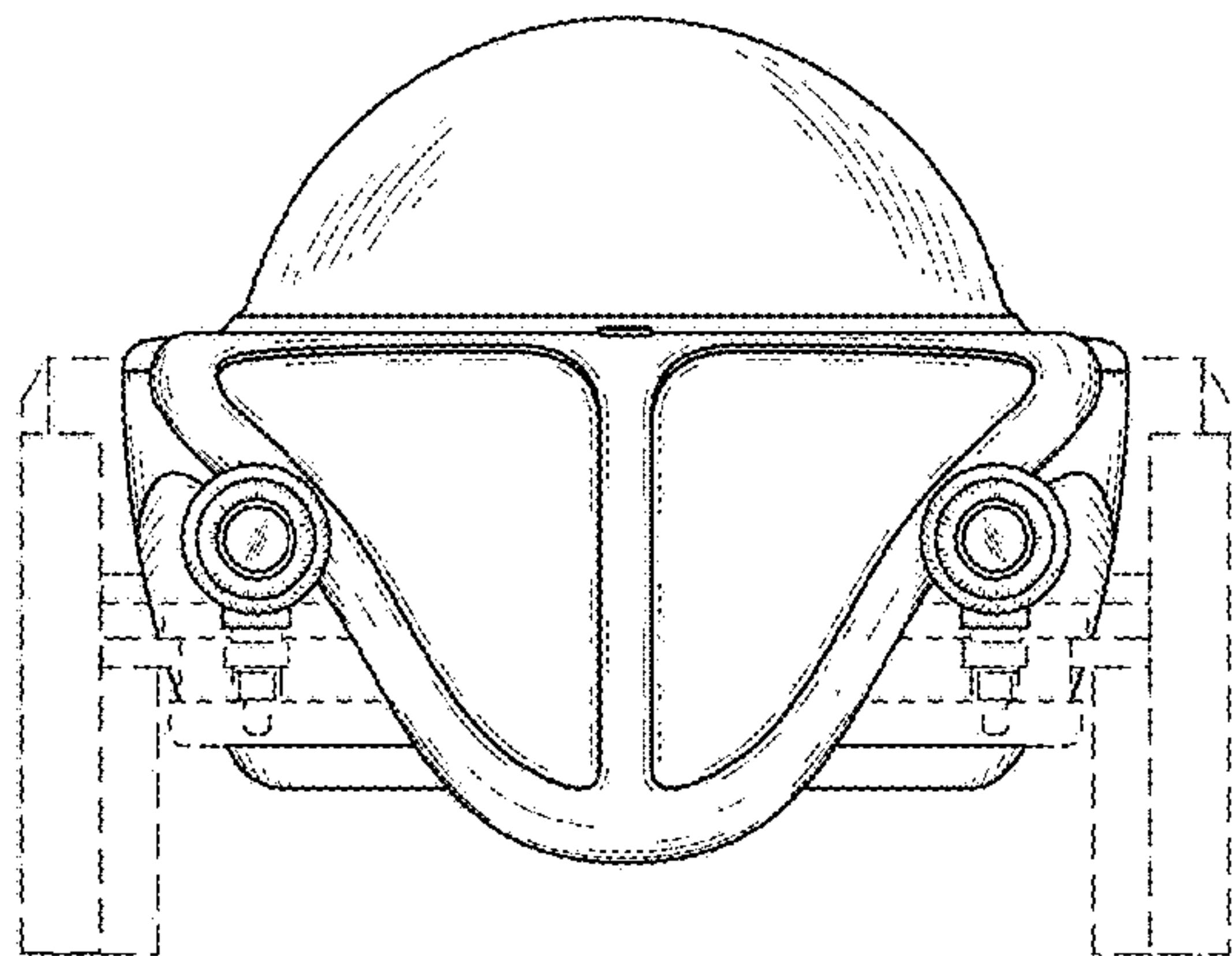
FIG. 1 is a front and side perspective view of a vehicle showing my new design;  
FIG. 2 is a front elevational view thereof;  
FIG. 3 is a rear elevational view thereof;  
FIG. 4 is a side elevational view thereof;  
FIG. 5 is an opposite side elevational view;  
FIG. 6 is a top plan view thereof; and,  
FIG. 7 is a bottom plan view thereof.  
The broken lines are for the purpose of illustration and form no part of the claimed design. The line segments on the surface portions indicate contour and not surface decoration.

**1 Claim, 3 Drawing Sheets**

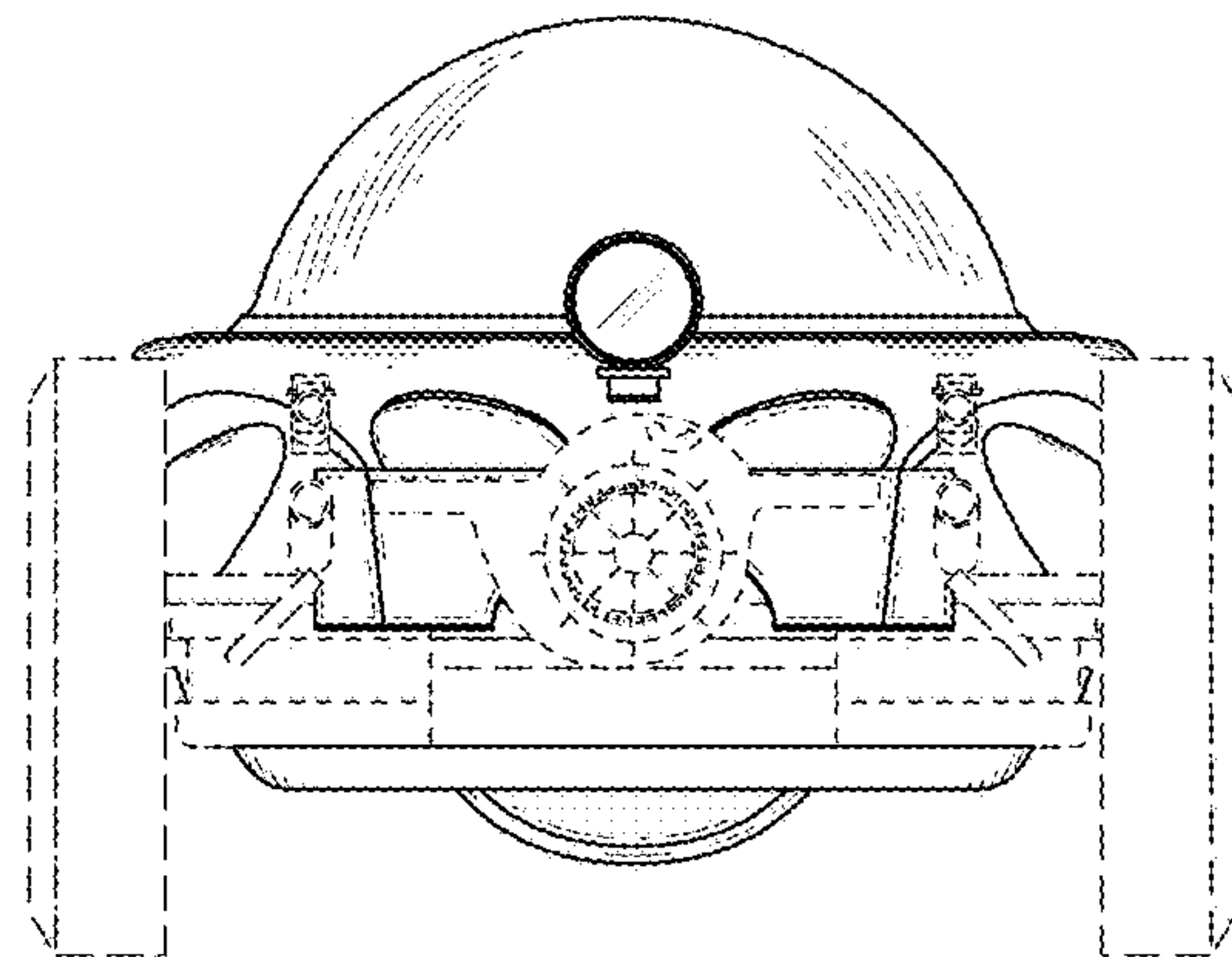




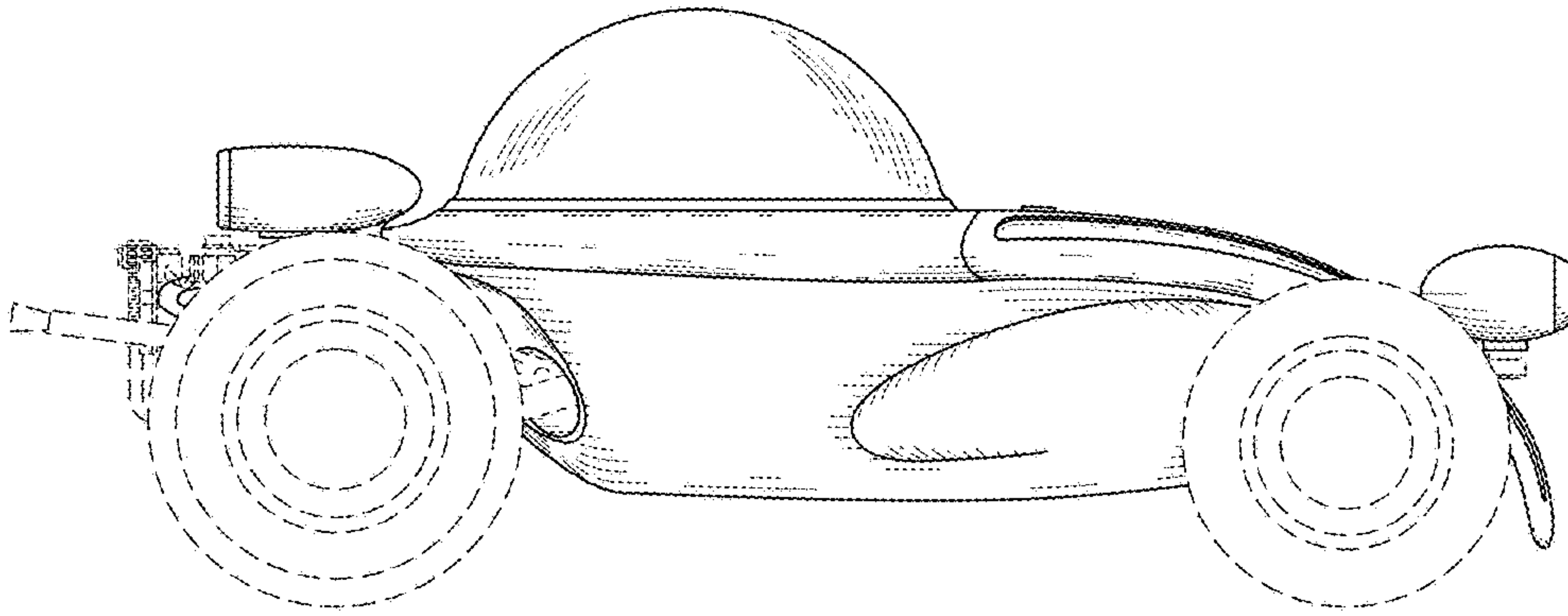
**FIG. 1**



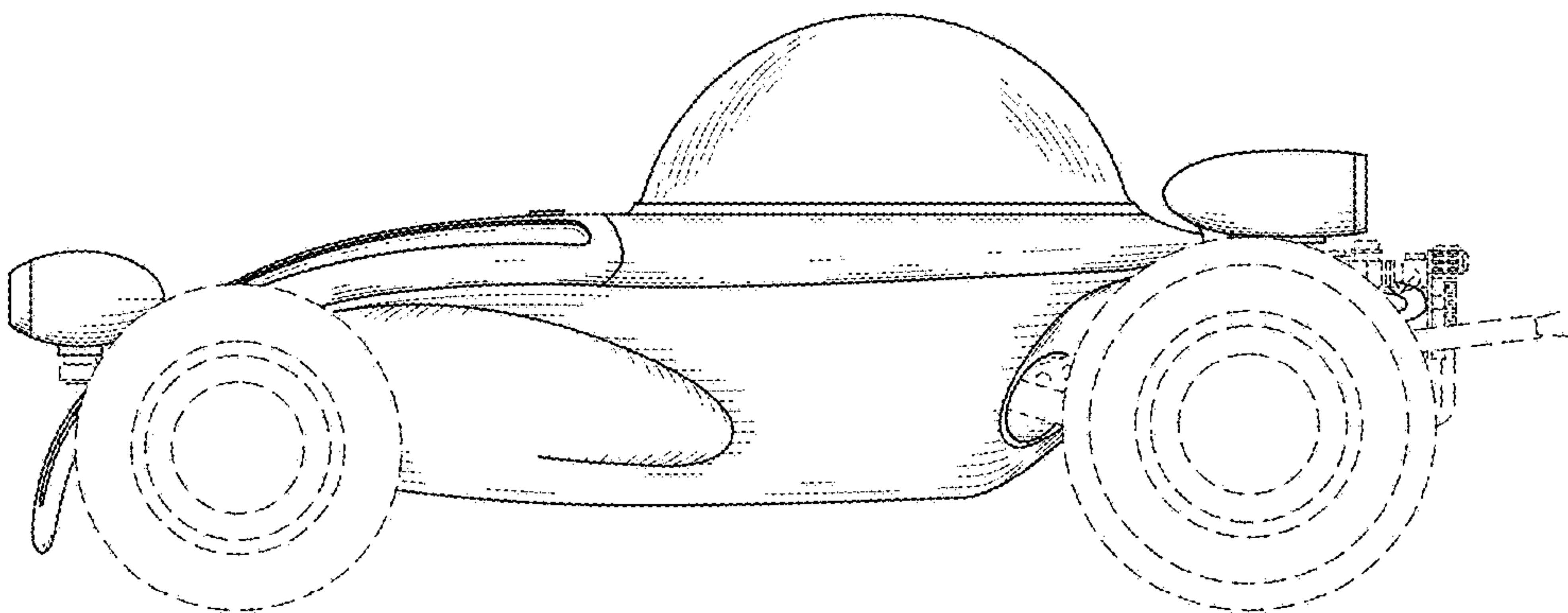
**FIG. 2**



**FIG. 3**



**FIG. 4**



**FIG. 5**



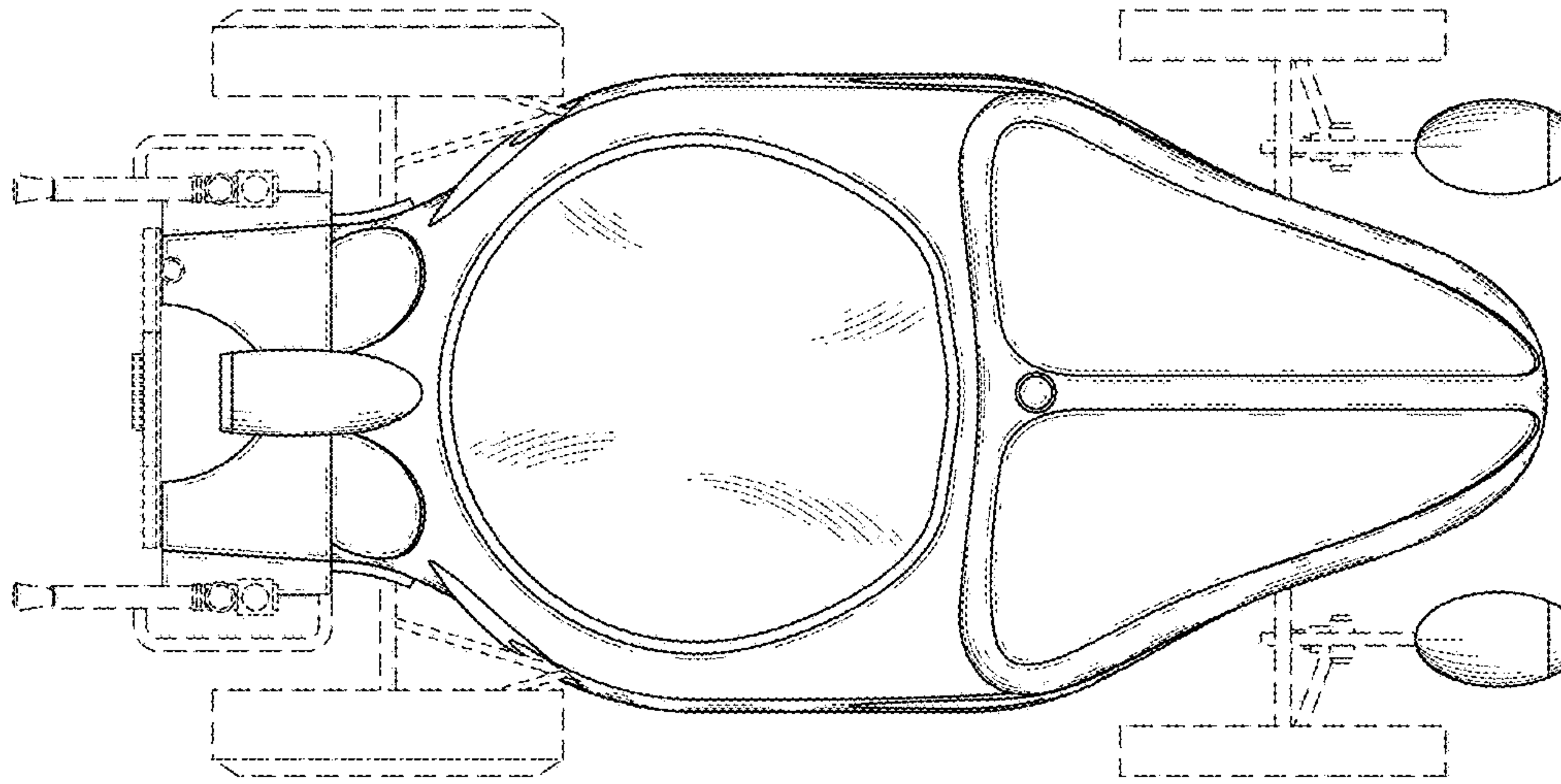


FIG. 6

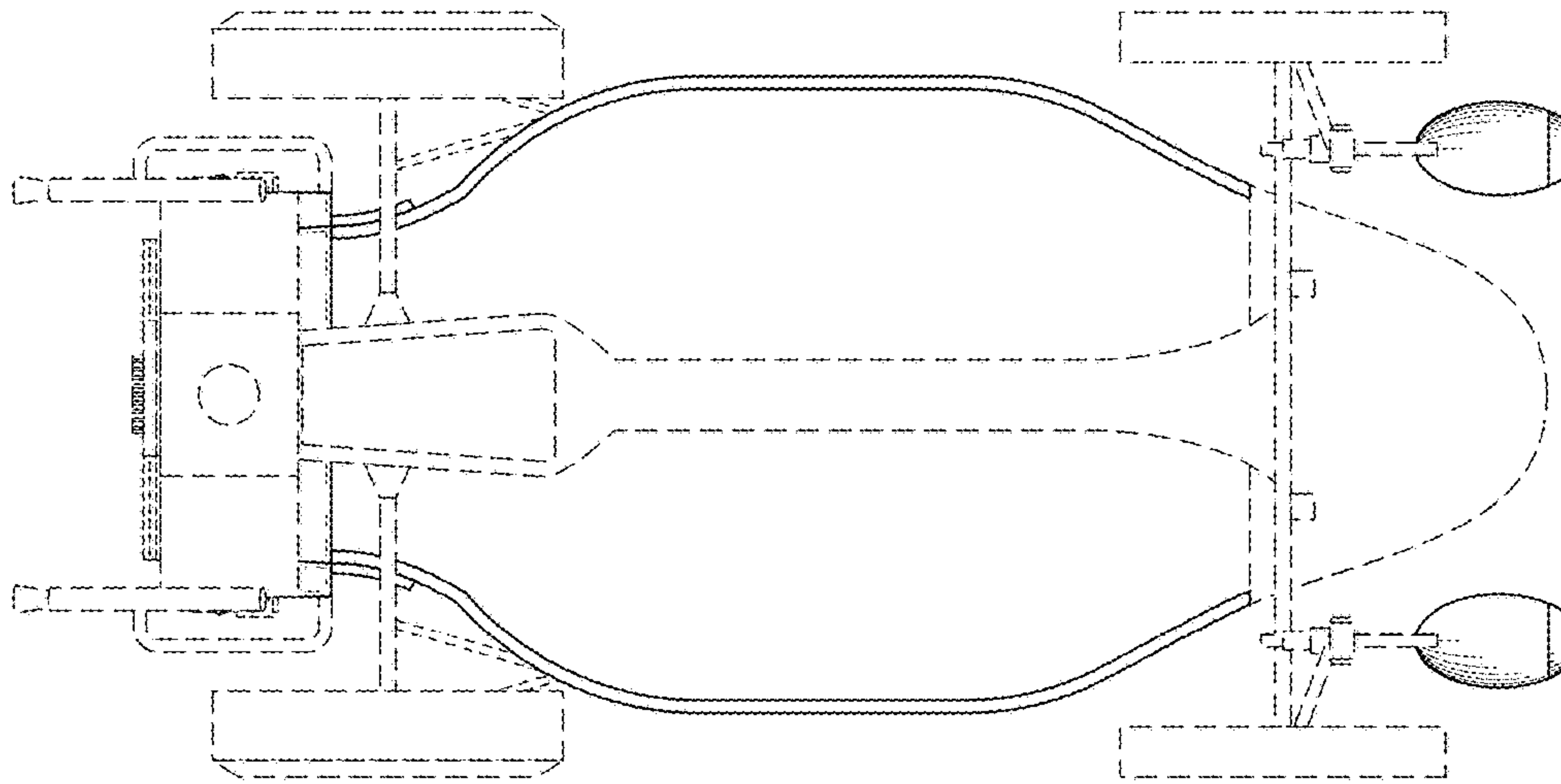


FIG. 7