



US00D826776S

(12) **United States Design Patent** (10) **Patent No.:** **US D826,776 S**
Grünewald et al. (45) **Date of Patent:** **** Aug. 28, 2018**

(54) **FASTENER FOR AN ACCESSORY BAND**

(71) Applicants: **Christian Grünewald**, Hessheim (DE);
Tanja Weissenrieder, Worms (DE)

(72) Inventors: **Christian Grünewald**, Hessheim (DE);
Tanja Weissenrieder, Worms (DE)

(**) Term: **15 Years**

(21) Appl. No.: **29/541,166**

(22) Filed: **Sep. 30, 2015**

(51) **LOC (11) Cl.** **02-07**

(52) **U.S. Cl.**
USPC **D11/216**

(58) **Field of Classification Search**
USPC D11/1-2, 200-201, 206-210, 214-218;
24/163 R, 169-171, 173, 177-179, 191,
24/194-195, 197, 200, 614-616, 625,
24/198, 578.11, 578.1, 163 K, 114;
D2/853, 624
CPC A44B 11/26; A44B 11/25; A44B 11/06;
A44B 11/04
See application file for complete search history.

(56) **References Cited**

U.S. PATENT DOCUMENTS

- D56,246 S * 9/1920 Alterson 24/616
- 2,586,758 A * 2/1952 Zerr A44C 5/2042
24/116 A
- D167,823 S * 9/1952 Bliss D11/200
- 2,986,792 A * 6/1961 Wyatt A44C 5/2047
24/616
- 3,148,426 A * 9/1964 Lesser A44B 11/005
224/163
- D200,155 S * 1/1965 Hedu D11/216
- D200,311 S * 2/1965 Lesser et al. D11/201
- 3,251,110 A * 5/1966 Hedu A44B 11/263
24/616
- D264,828 S * 6/1982 Gray D11/87
- D284,642 S * 7/1986 Kabaya D10/38

- 4,736,494 A 4/1988 Marchesi
 - D300,614 S * 4/1989 Geldwerth D11/216
 - 5,231,740 A * 8/1993 Mohebkhosravi ... A44C 5/2047
24/574.1
 - 5,933,926 A 8/1999 Reiter
 - D442,113 S * 5/2001 Nisguretsky D11/86
 - D521,410 S * 5/2006 Nottingham A01K 27/005
D11/216
 - 7,178,207 B2 2/2007 Wong et al.
 - D562,371 S * 2/2008 Erickson D11/216
- (Continued)

FOREIGN PATENT DOCUMENTS

- DE 3736254 5/1989
- DE 20309634 8/2003

Primary Examiner — Ralf Seifert

(74) *Attorney, Agent, or Firm* — Boyle Fredrickson S.C.

(57) **CLAIM**

The ornamental design for fastener for an accessory band, as shown and described.

DESCRIPTION

FIG. 1 is a front perspective view of a fastener for an accessory band showing our new design;
 FIG. 2 is a back perspective view of the fastener shown in FIG. 1;
 FIG. 3 is a front view of the fastener shown in FIG. 1;
 FIG. 4 is a back side view shown with the strap broken away for ease of illustration;
 FIG. 5 is a top view of the fastener shown in FIG. 1, wherein the bottom view is a mirror image of the top view and therefore not separately shown;
 FIG. 6 is a left side view of the fastener shown in FIG. 1; and,
 FIG. 7 is a right side view of the fastener shown in FIG. 1. The dashed lines in FIGS. 1 and 3 are for illustrative purposes only and form no part of the claimed design.

1 Claim, 2 Drawing Sheets

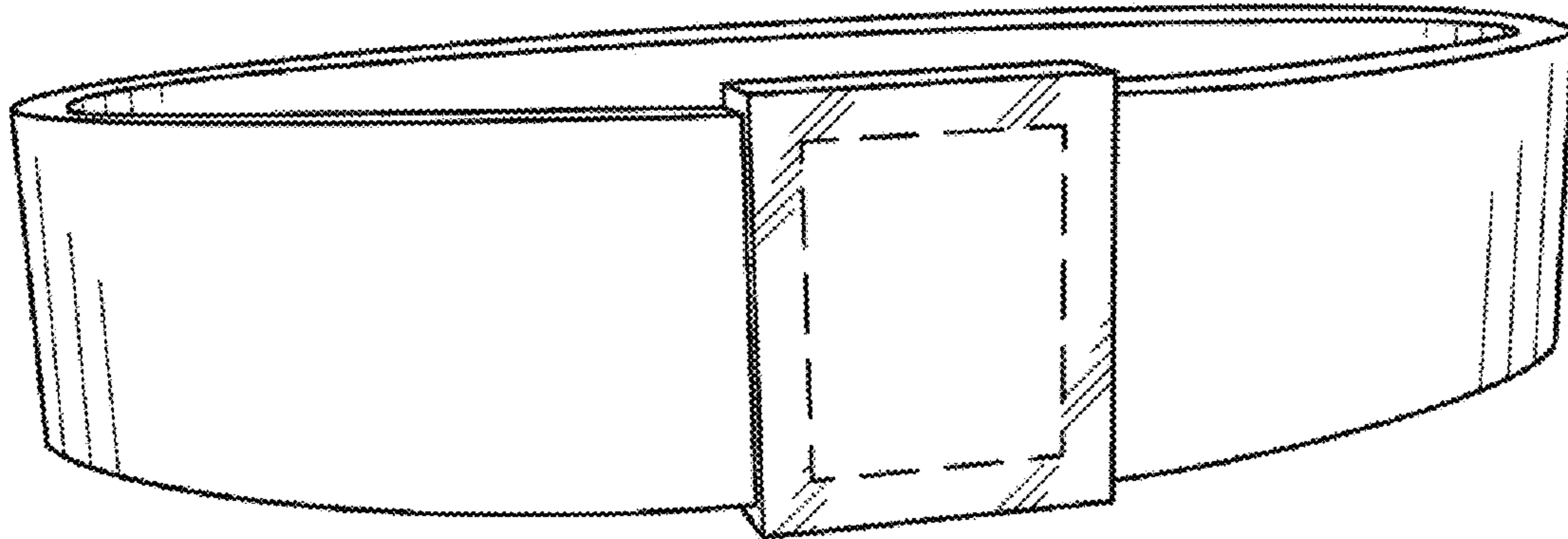

(56)

References Cited

U.S. PATENT DOCUMENTS

D591,633	S	*	5/2009	Del Valle	D11/3
D673,874	S	*	1/2013	Long	D11/1
D724,991	S	*	3/2015	Oh	D11/87
D725,538	S	*	3/2015	Oh	D11/87
D725,539	S	*	3/2015	Oh	D11/87
D737,718	S	*	9/2015	Oh	D11/87
D738,251	S	*	9/2015	Oh	D11/87

* cited by examiner

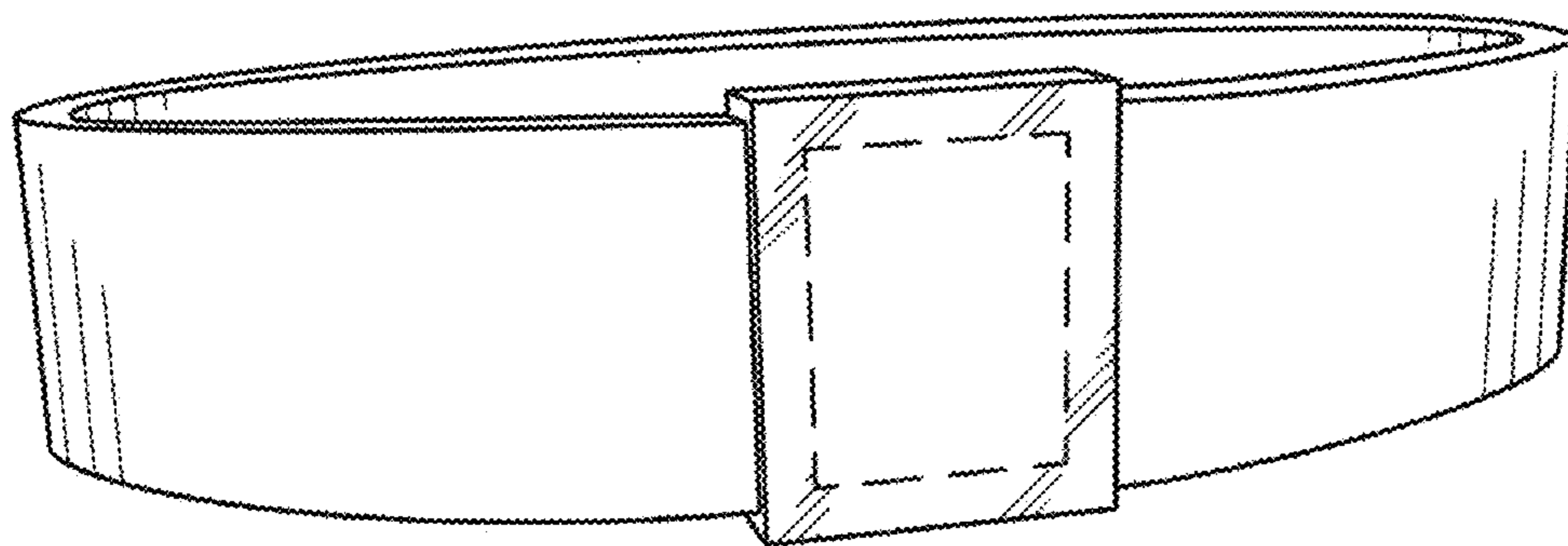

FIG. 1

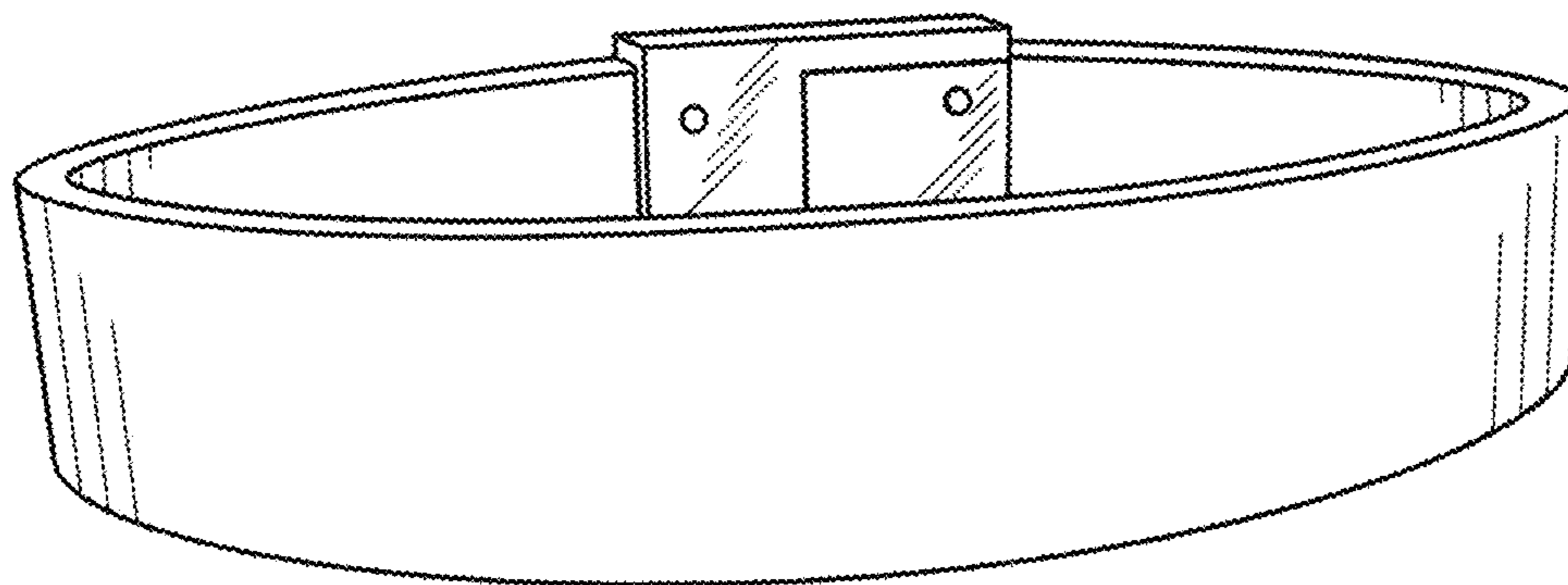

FIG. 2

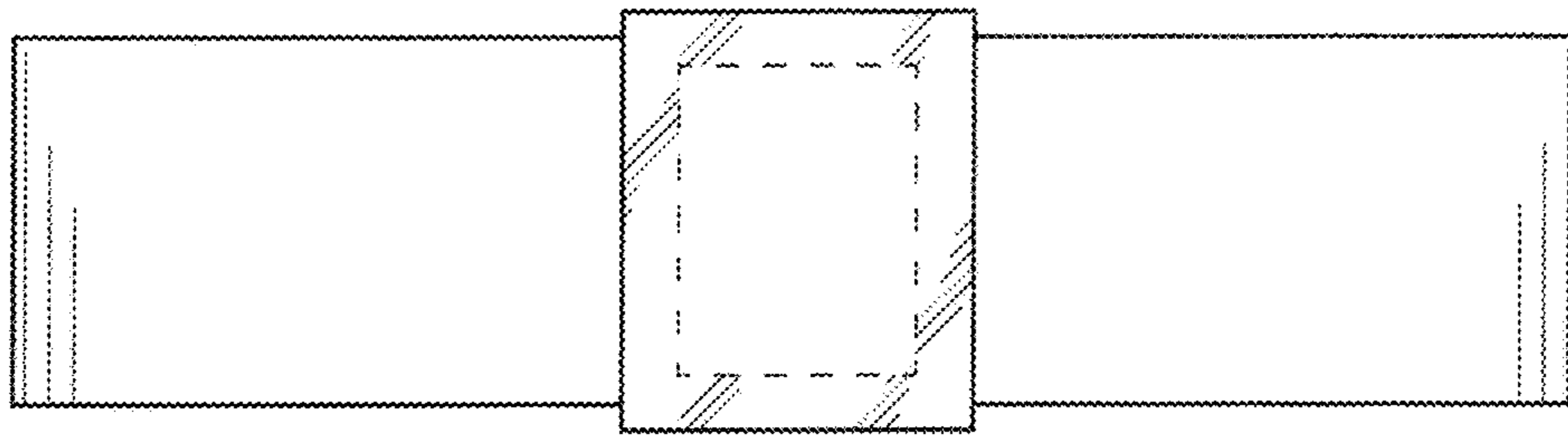

FIG. 3

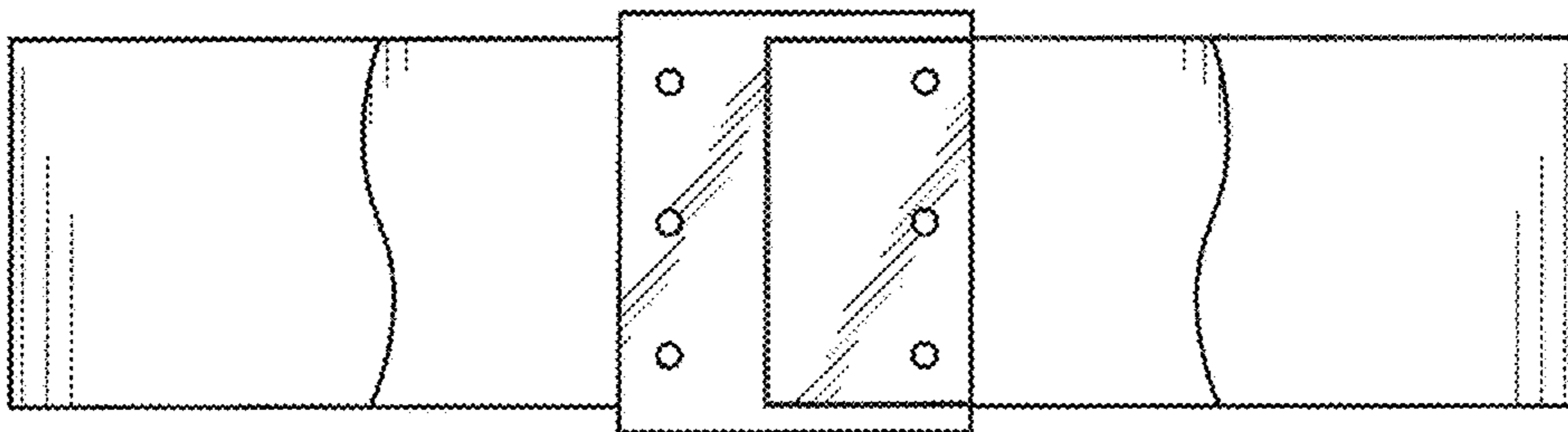

FIG. 4

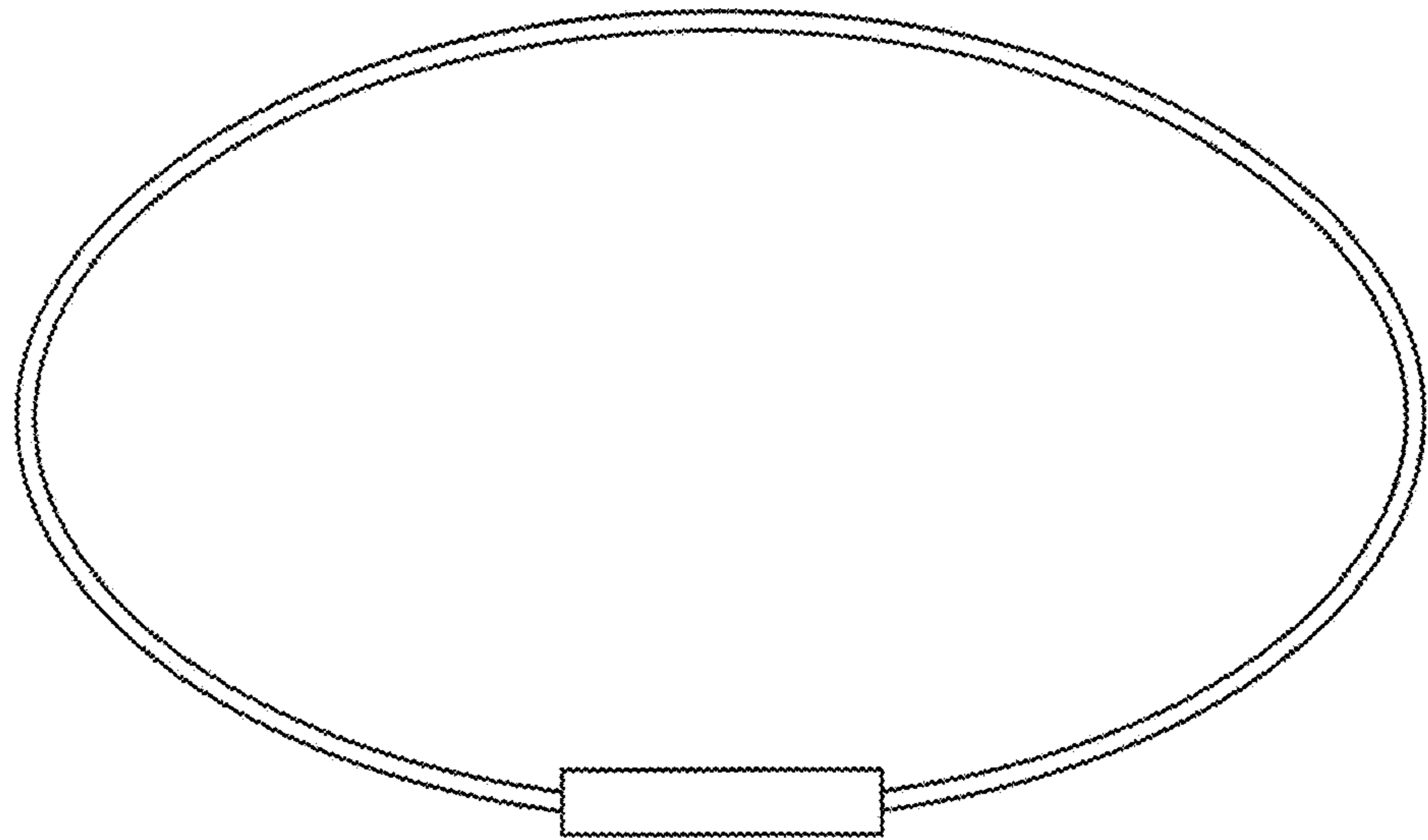

FIG. 5

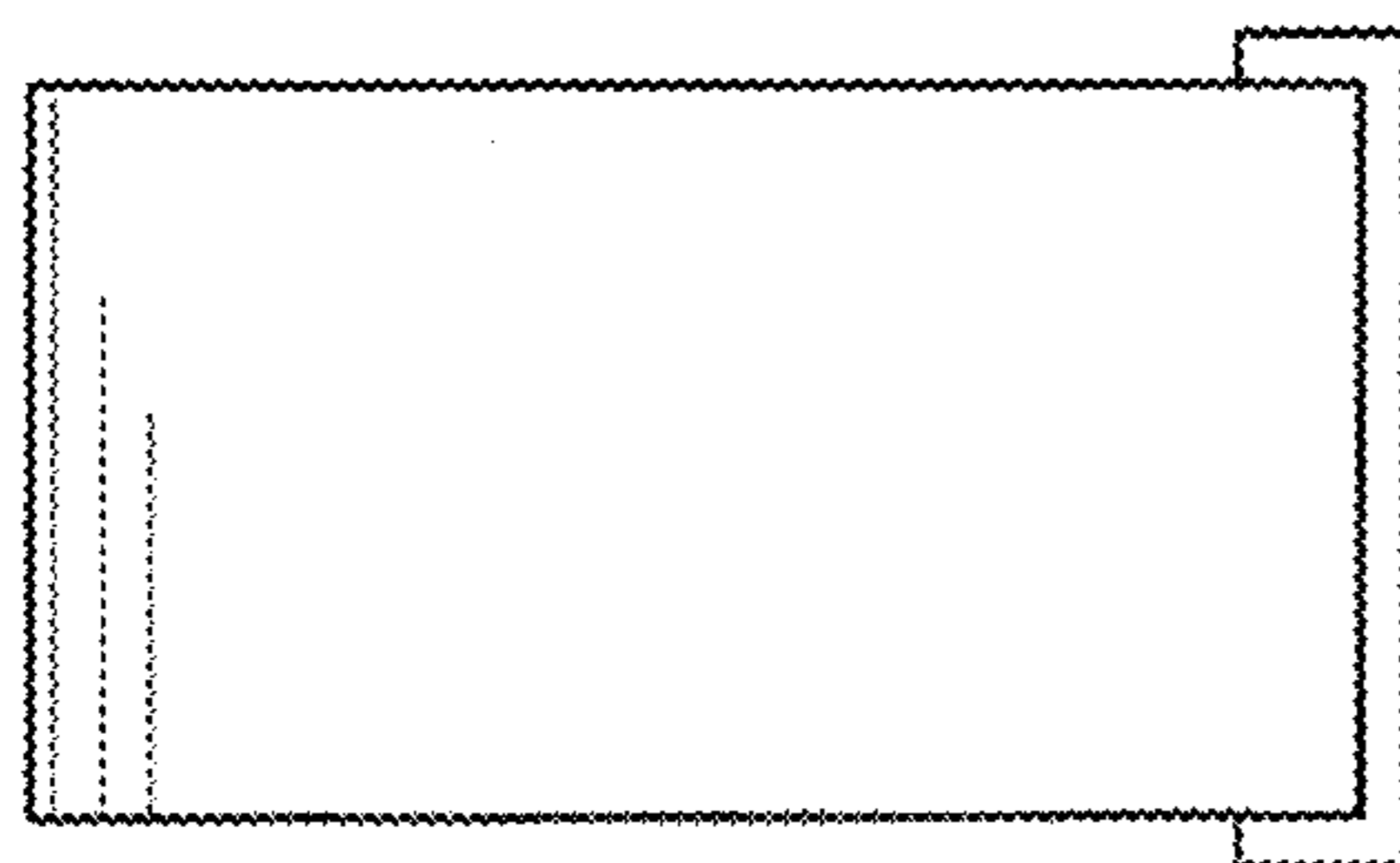

FIG. 6

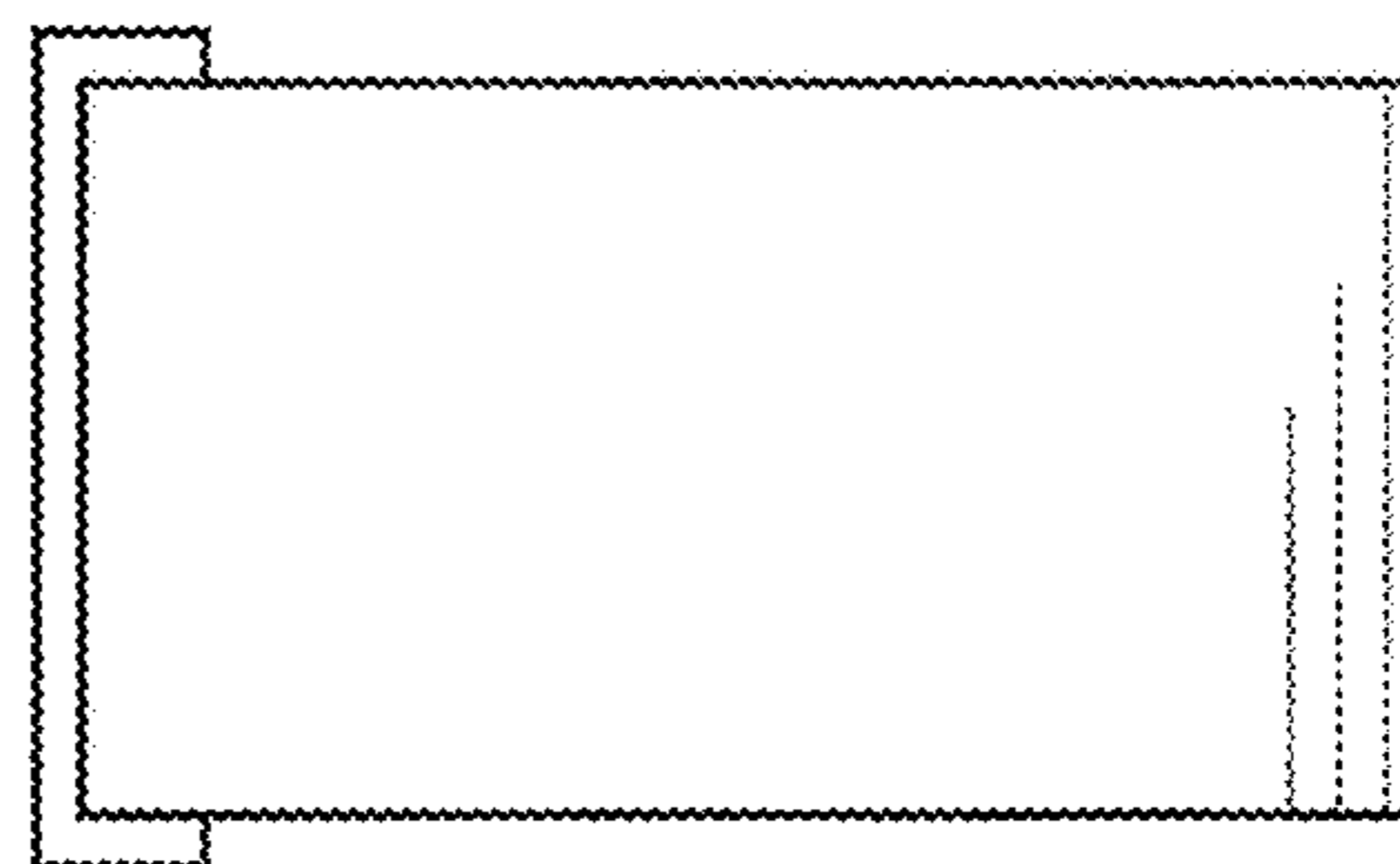

FIG. 7