



US00D826682S

(12) **United States Design Patent**
Huhn

(10) **Patent No.:** **US D826,682 S**

(45) **Date of Patent:** **** Aug. 28, 2018**

(54) **SANITARY HANDLE**

(71) Applicant: **Sani-Hani Corp.**, Aurora, CO (US)

(72) Inventor: **Ryan T. Huhn**, Aurora, CO (US)

(73) Assignee: **Sani-Hani Corp.**, Aurora, CO (US)

(**) Term: **15 Years**

(21) Appl. No.: **29/593,676**

(22) Filed: **Feb. 10, 2017**

(51) **LOC (11) Cl.** **08-06**

(52) **U.S. Cl.**
USPC **D8/307**

(58) **Field of Classification Search**

USPC D8/107, 300, 301, 307, 308, DIG. 1,
D8/DIG. 10; D23/270, 303, 309, 310,
D23/311; D7/393, 395

CPC Y10T 16/19; Y10T 16/643; Y10T 16/191;
Y10T 16/95; Y10T 24/4088; Y10T
292/1049; A47K 13/10; A47K 13/105;
A47K 13/24; E03D 5/092; E03D 5/04

See application file for complete search history.

(56) **References Cited**

U.S. PATENT DOCUMENTS

1,999,555	A *	4/1935	Adams	A47K 13/105 16/443
4,875,251	A *	10/1989	Hazard	A47K 13/105 16/427
D311,218	S *	10/1990	Althans	D13/168
D356,366	S *	3/1995	Denapoli	D23/311
5,725,264	A *	3/1998	Villarreal	E05B 1/0053 292/347
D406,884	S *	3/1999	Goss	D23/311
D427,293	S *	6/2000	Yastrop	D8/307
D432,892	S *	10/2000	Nakatani	D8/307

D469,857	S *	2/2003	Lim	D23/252
D497,982	S *	11/2004	Graves	D23/309
D643,910	S *	8/2011	Fritz	D23/250
D745,774	S *	12/2015	Pildes	D3/12
2011/0239358	A1 *	10/2011	Mendoza	A47K 13/105 4/246.1

* cited by examiner

Primary Examiner — Lauren R Calve

(74) *Attorney, Agent, or Firm* — Polsinelli PC

(57) **CLAIM**

The ornamental design for a sanitary handle, as shown and described.

DESCRIPTION

FIG. 1 is a perspective view of a sanitary handle according to a first embodiment.

FIG. 2 is a front view thereof.

FIG. 3 is a back view thereof.

FIG. 4 is a right side view thereof.

FIG. 5 is a left side view thereof.

FIG. 6 is a top view thereof.

FIG. 7 is a bottom view thereof.

FIG. 8 is a perspective view thereof shown in environmental use.

FIG. 9 is a perspective view of a sanitary handle according to a second embodiment.

FIG. 10 is a front view thereof.

FIG. 11 is a back view thereof.

FIG. 12 is a right side view thereof.

FIG. 13 is a left side view thereof.

FIG. 14 is a top view thereof.

FIG. 15 is a bottom view thereof; and,

FIG. 16 is a perspective view thereof shown in environmental use.

1 Claim, 10 Drawing Sheets

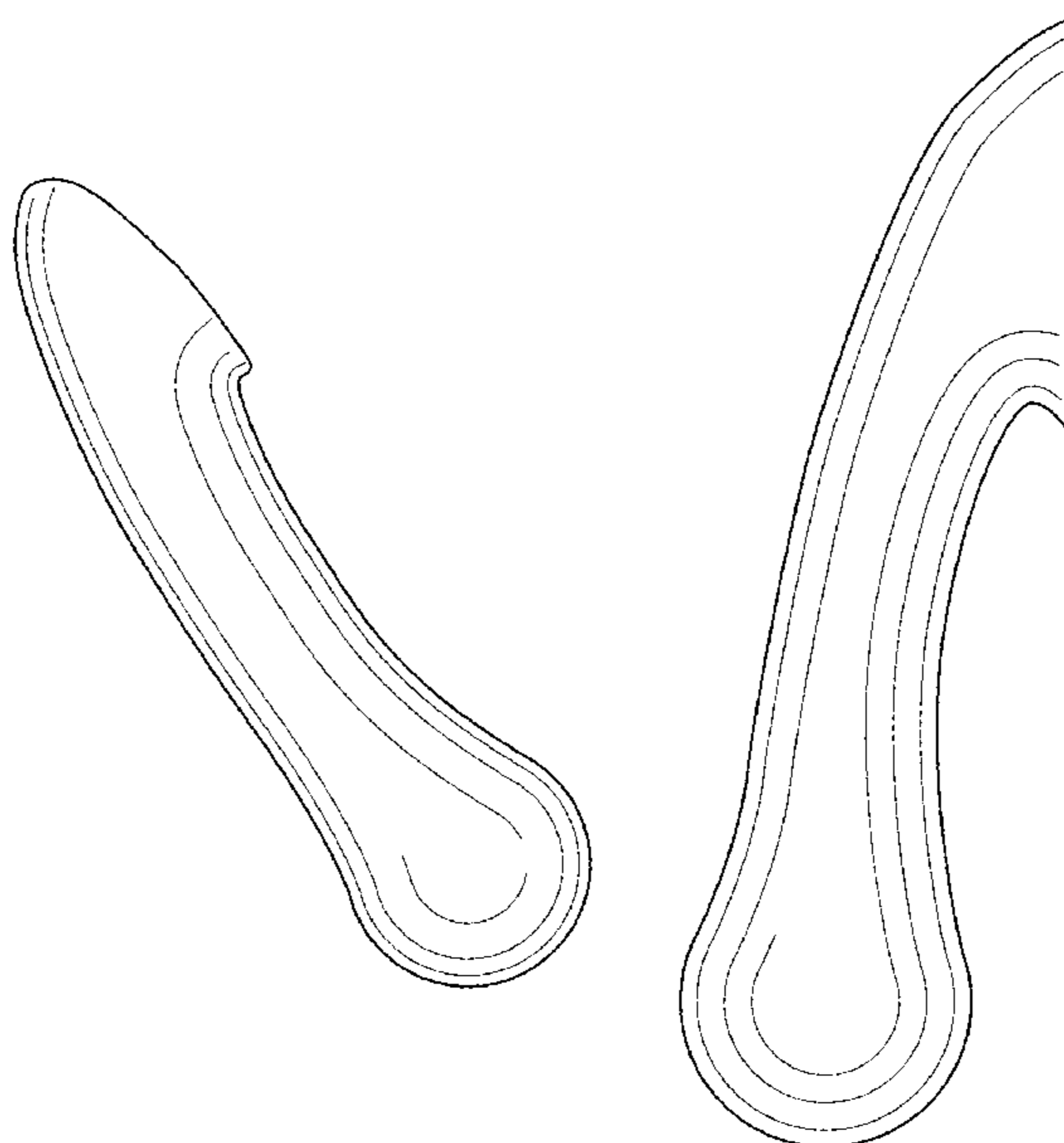

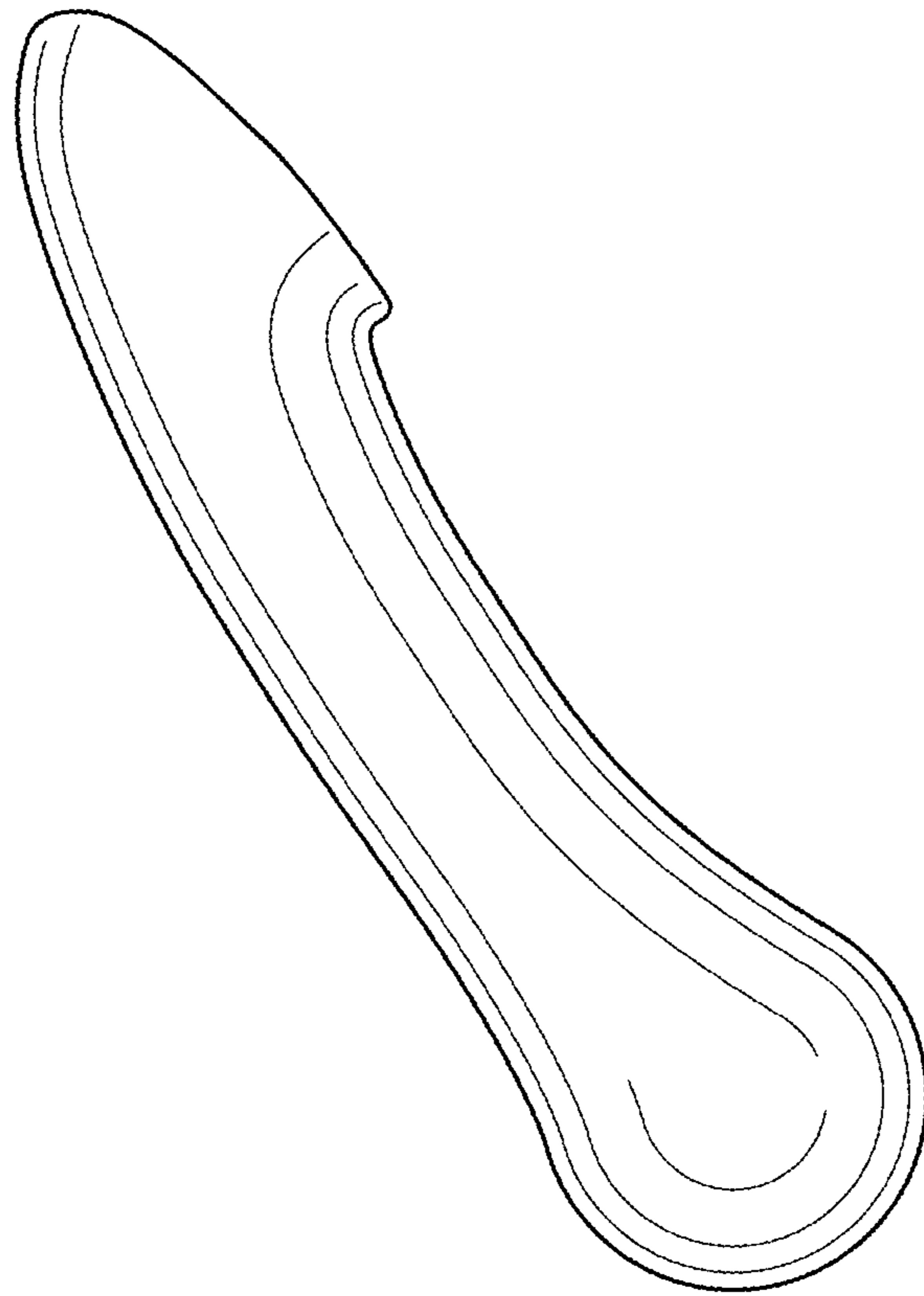

FIG.1

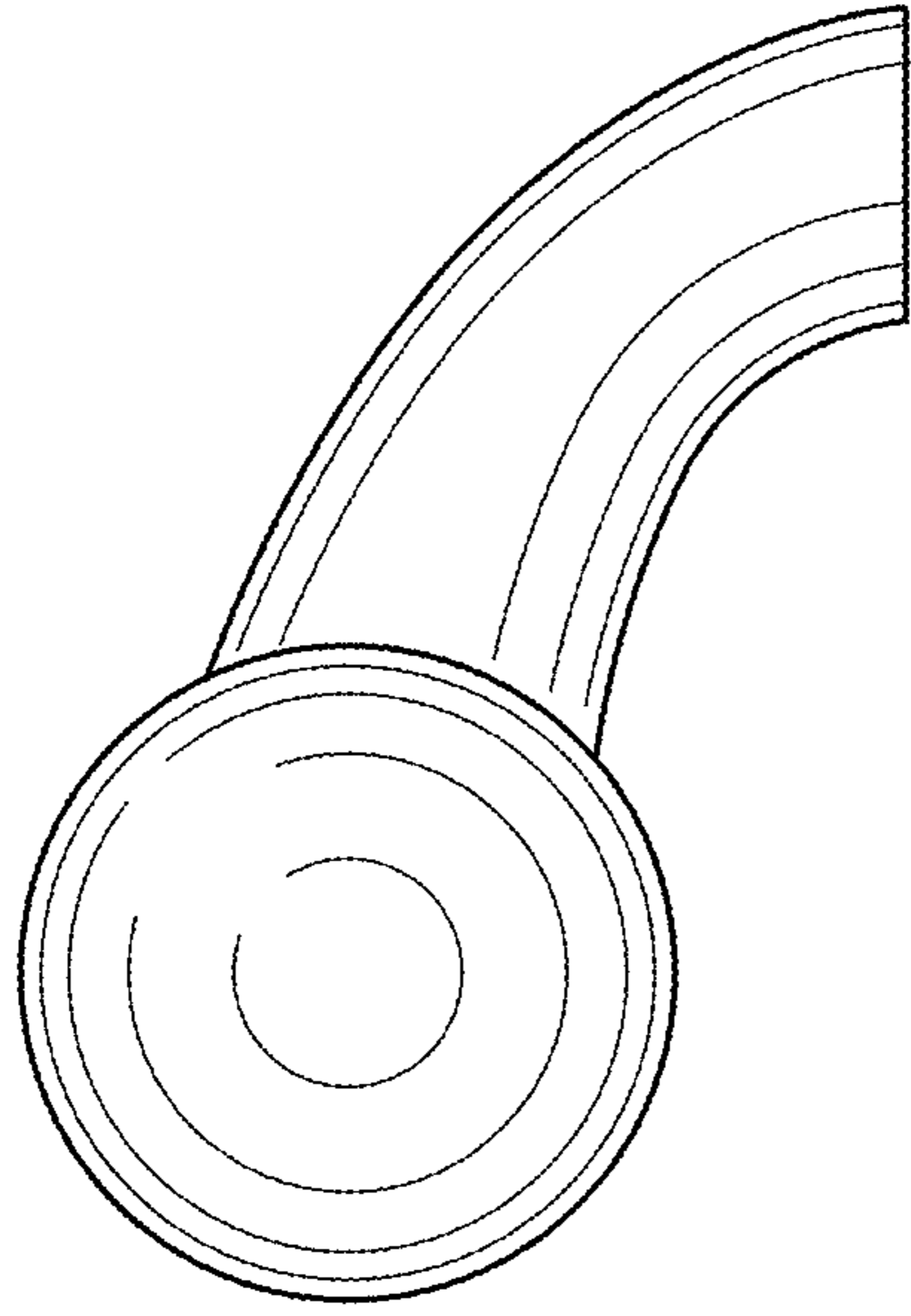

FIG. 2

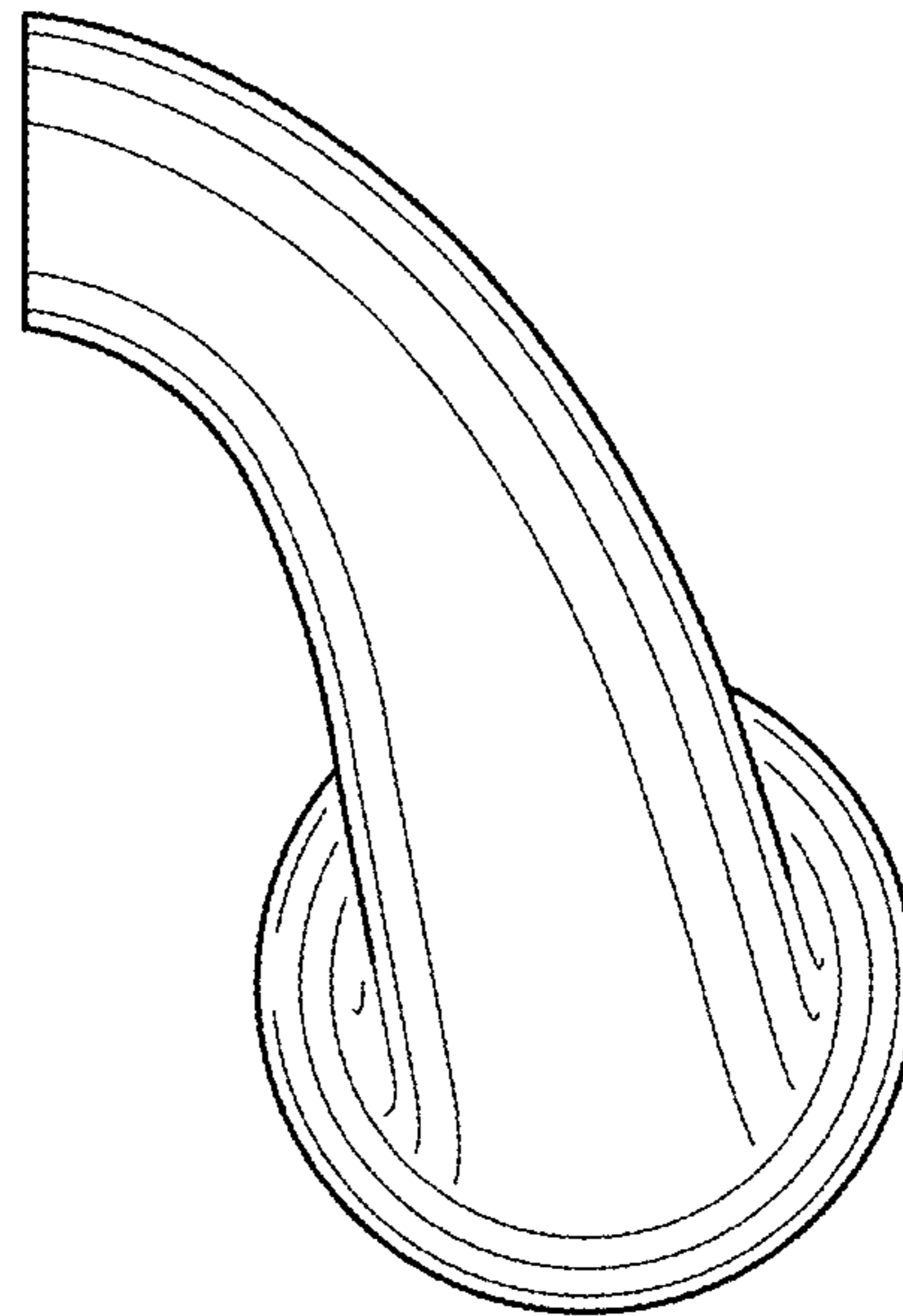

FIG. 3

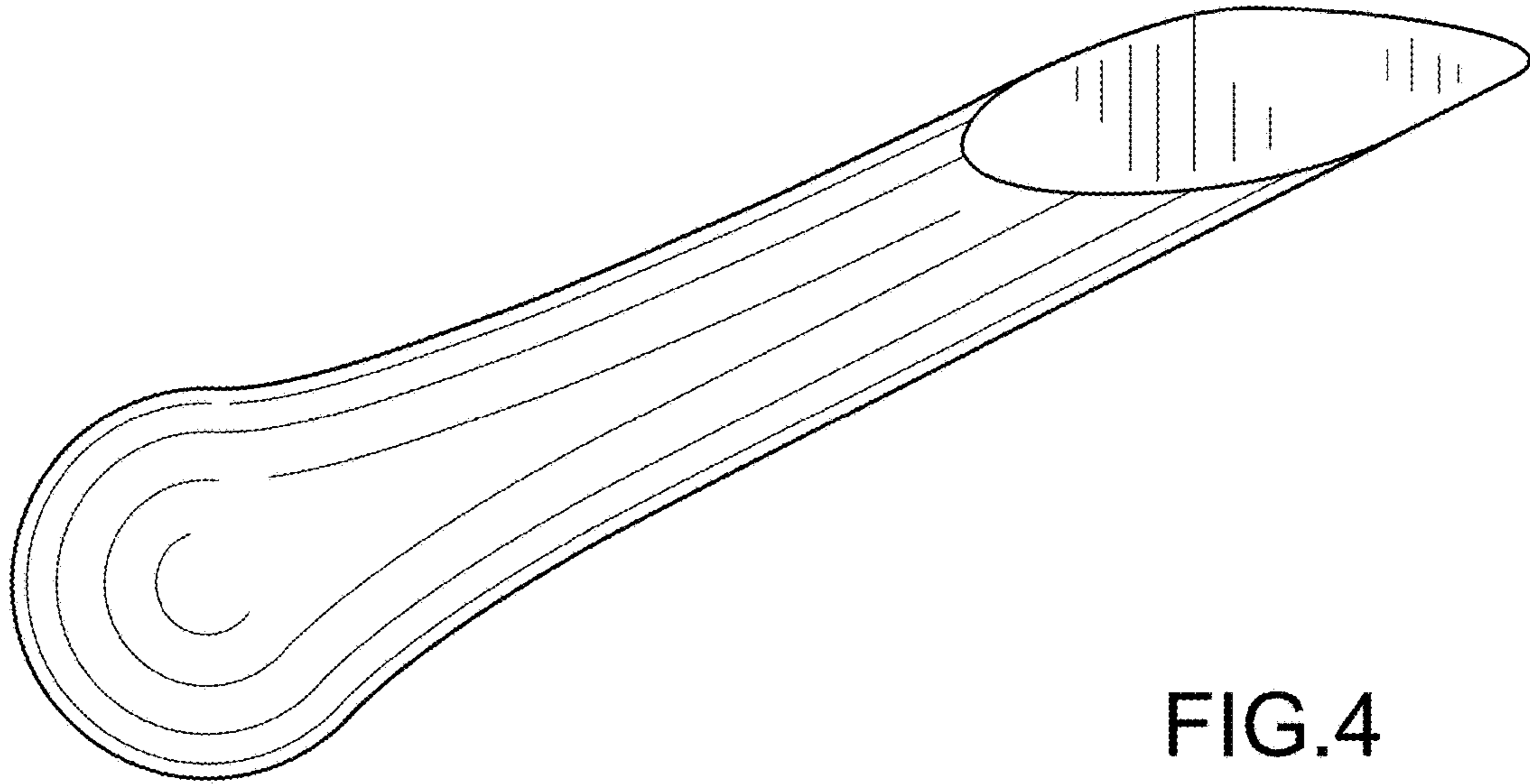

FIG. 4

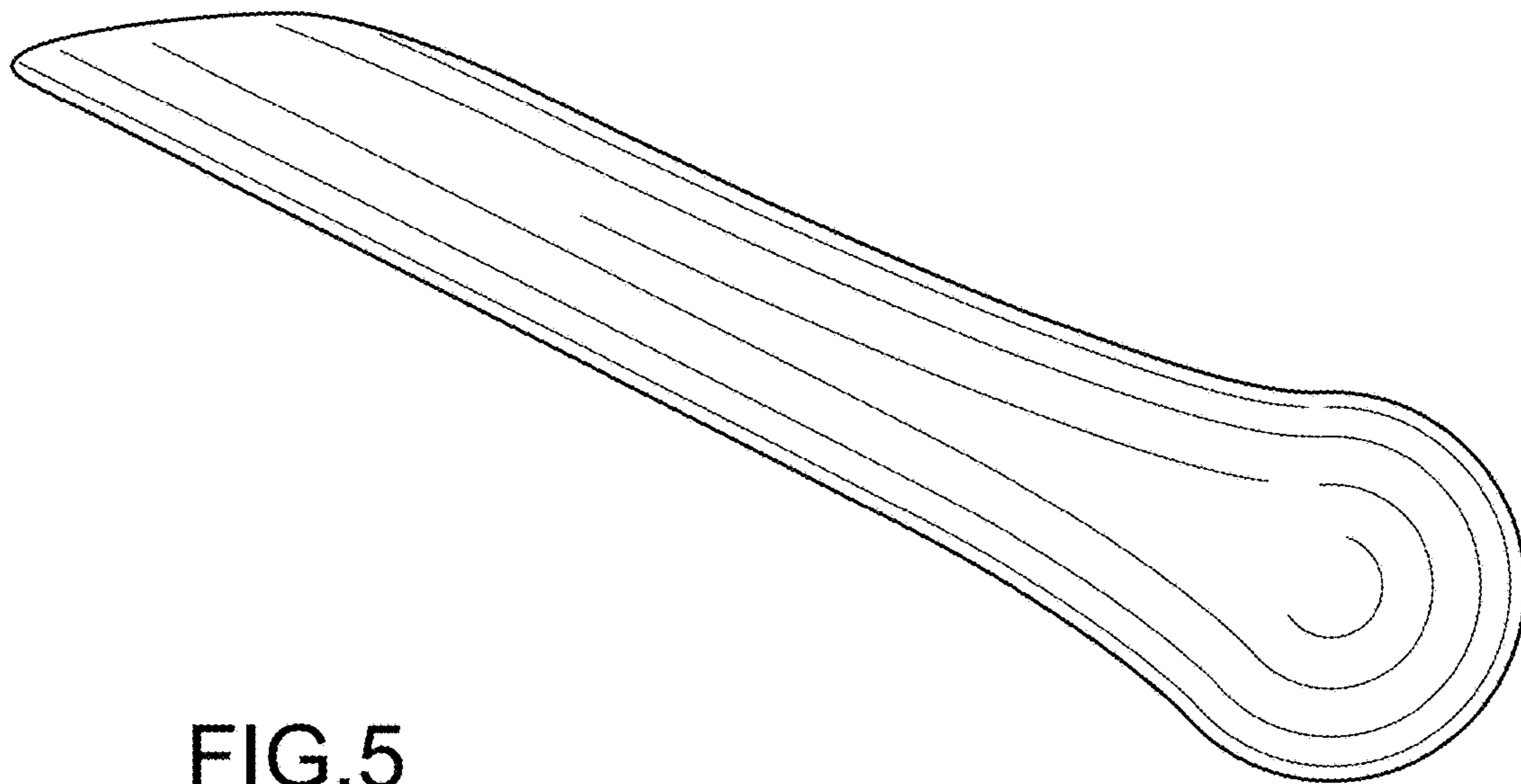

FIG. 5

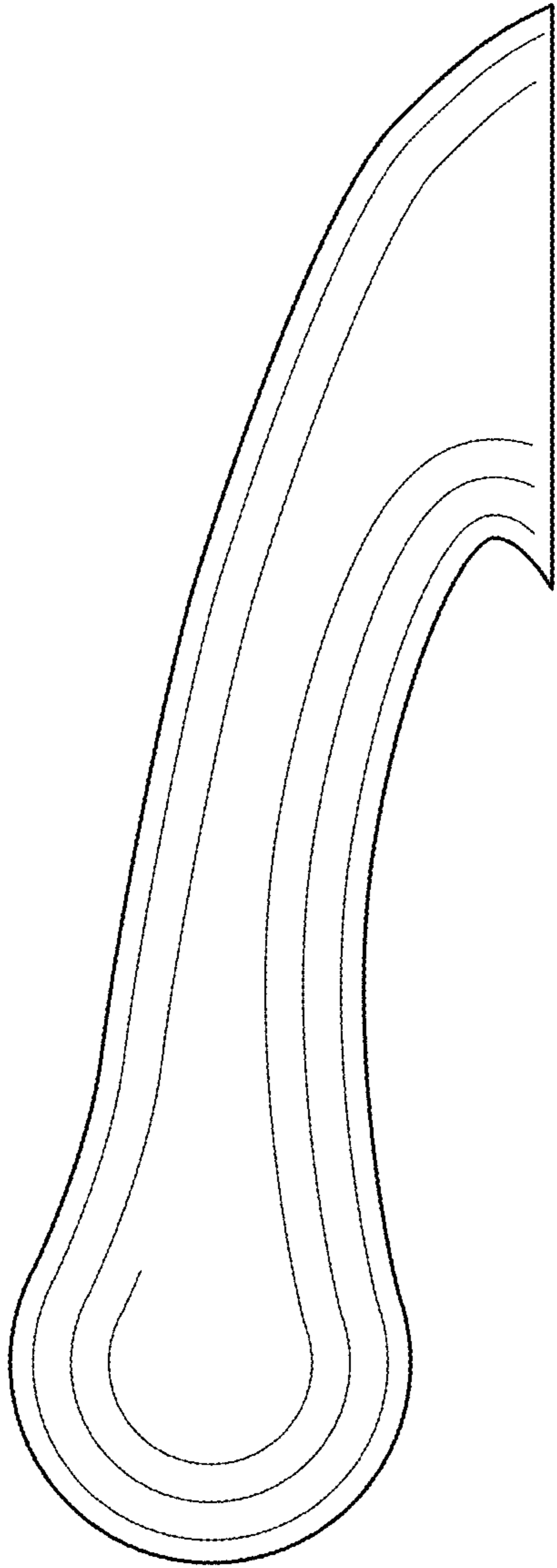

FIG. 6

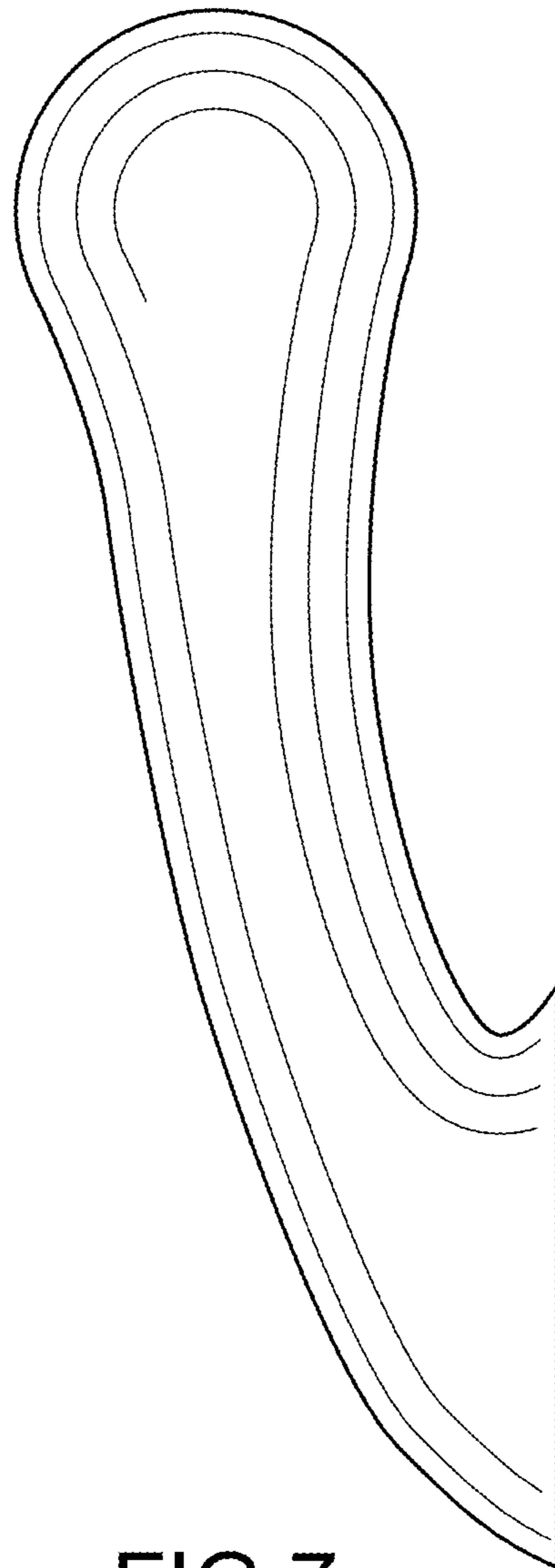

FIG. 7

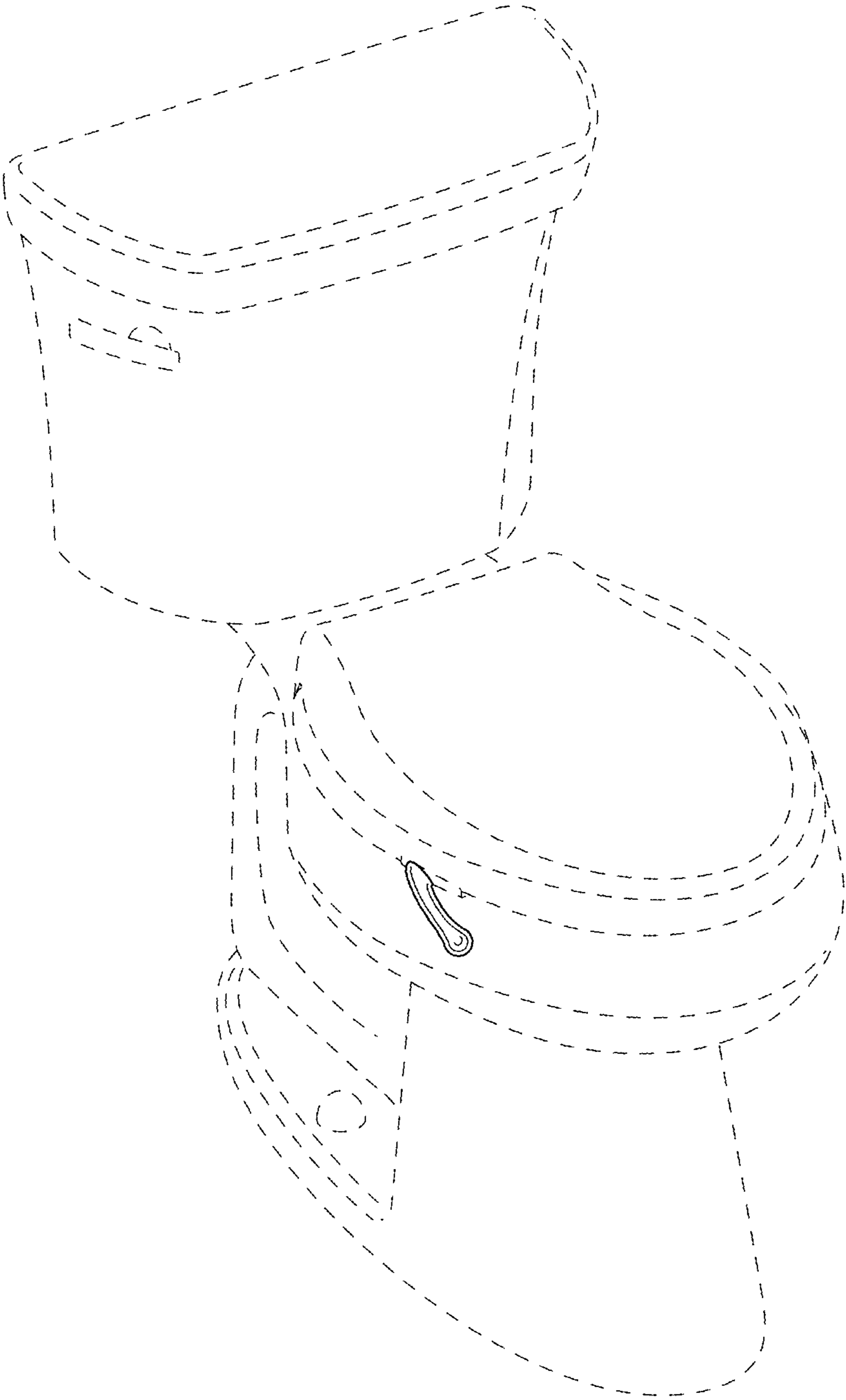

FIG.8

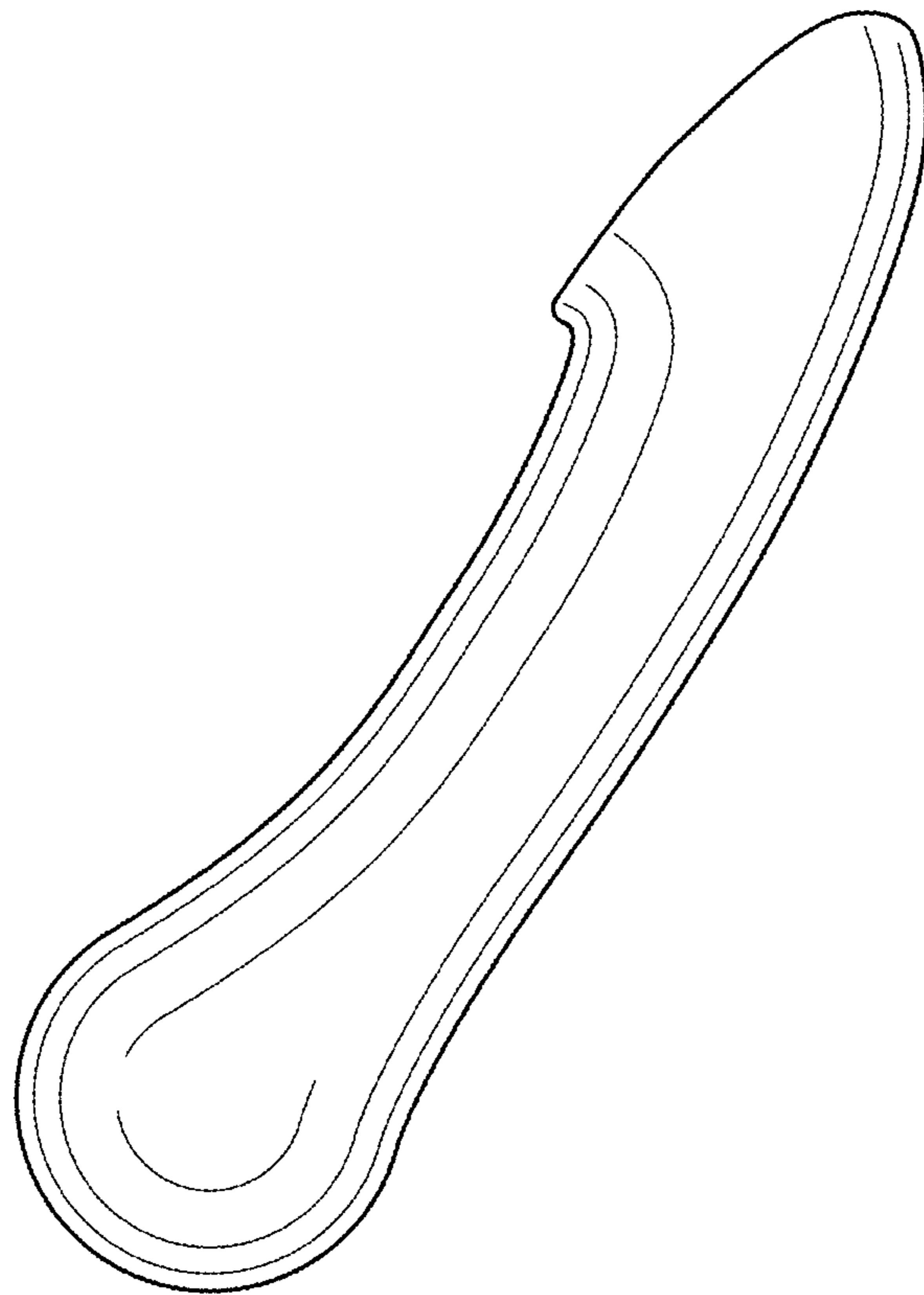

FIG.9

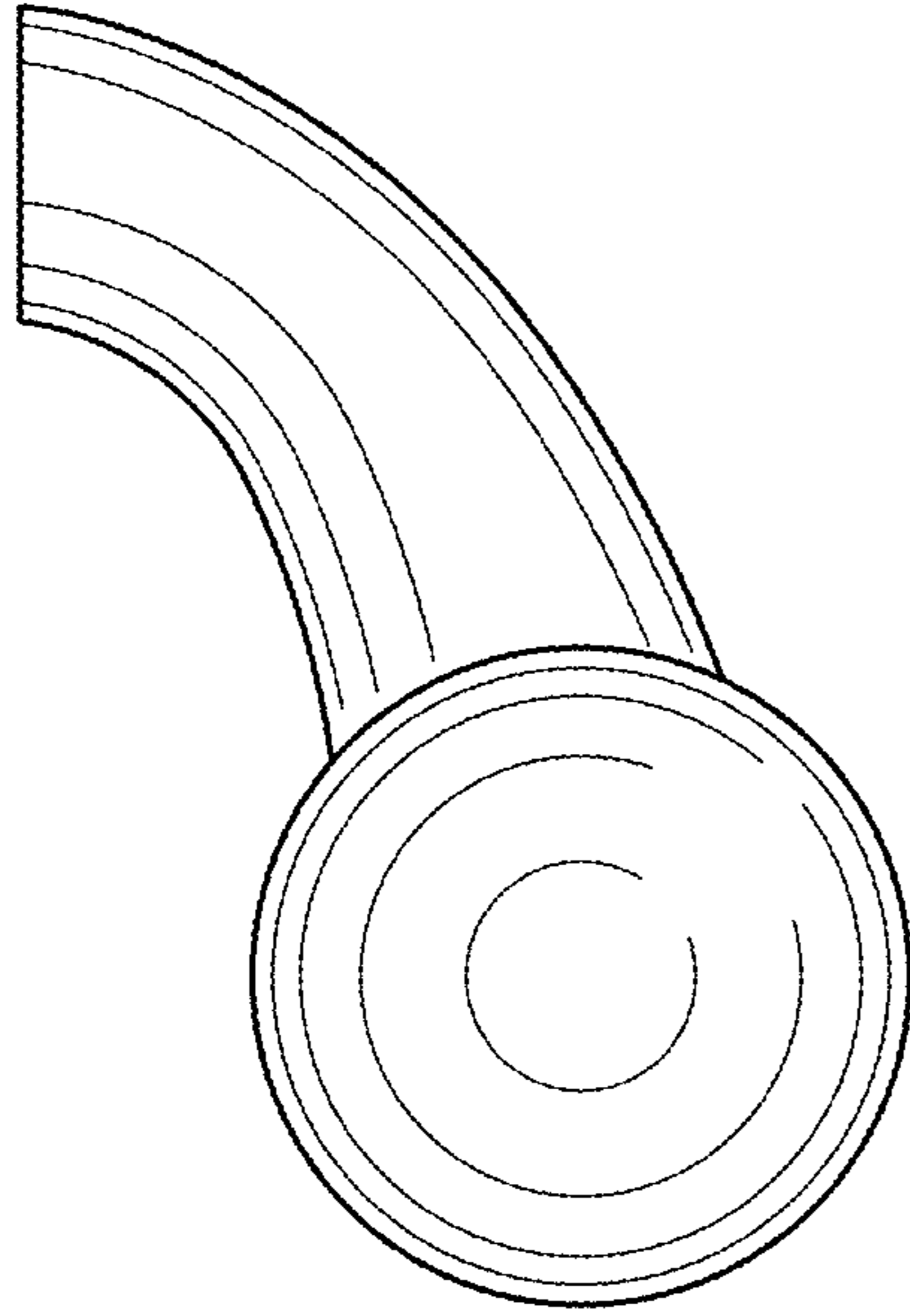

FIG. 10

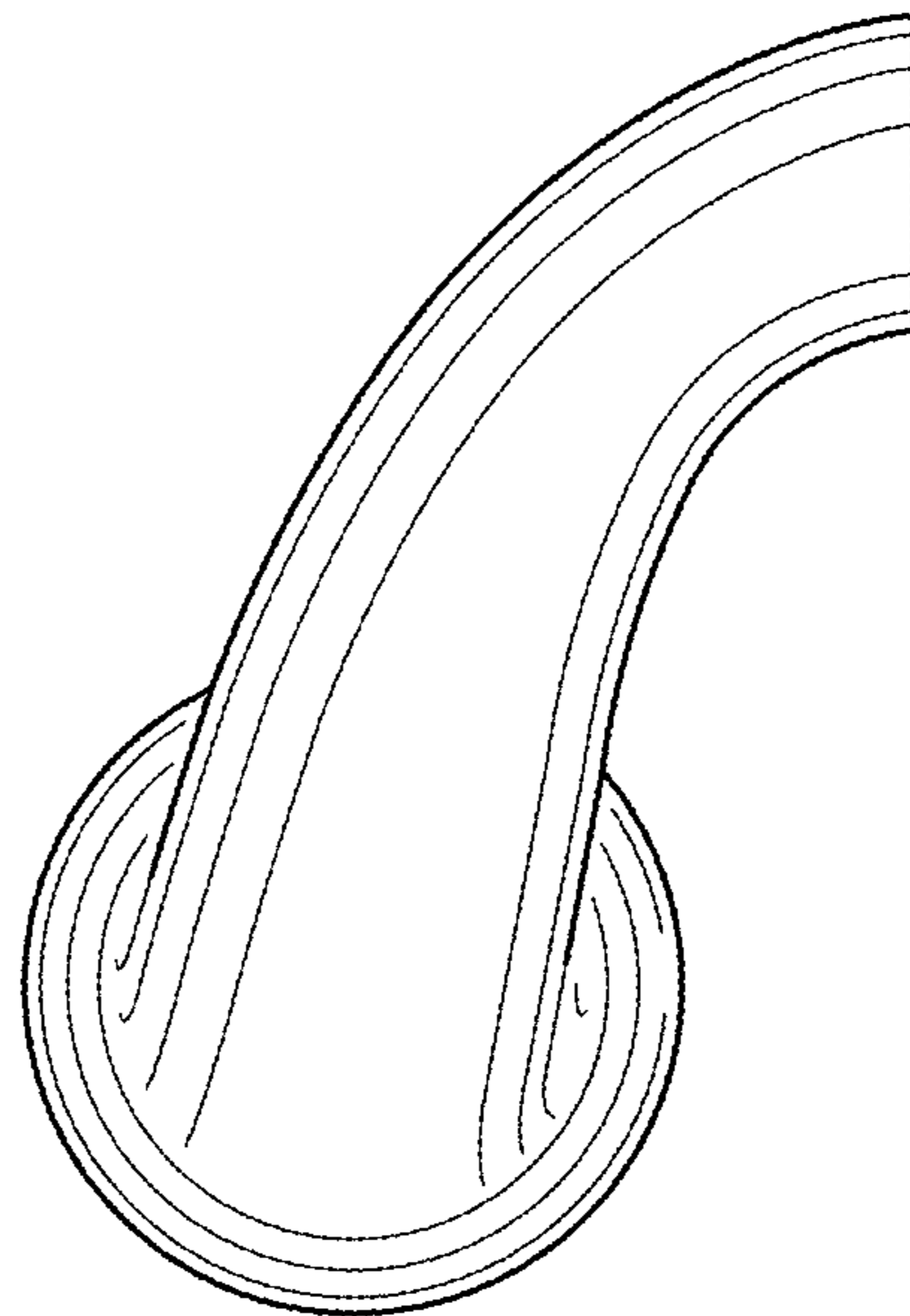

FIG. 11

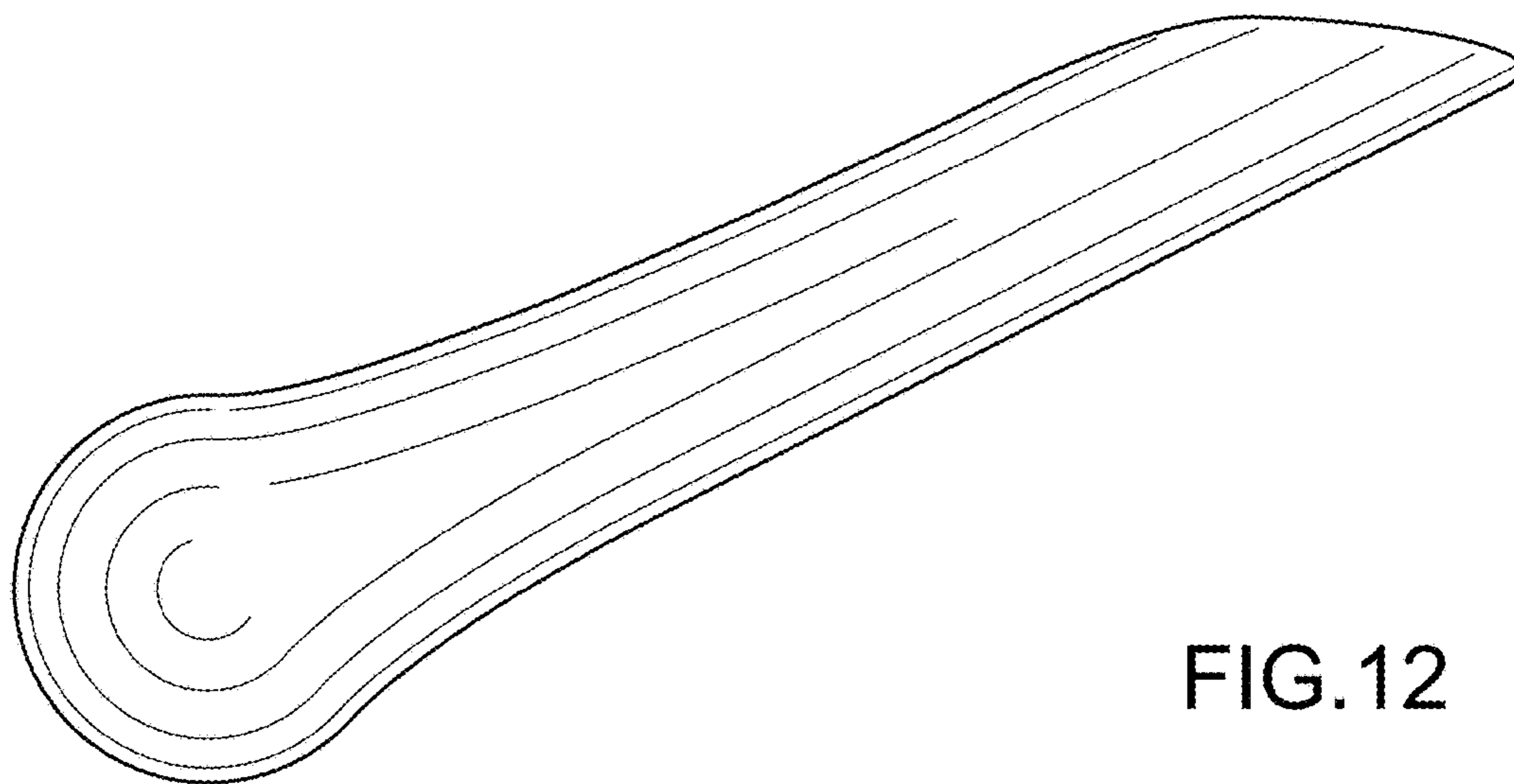

FIG.12

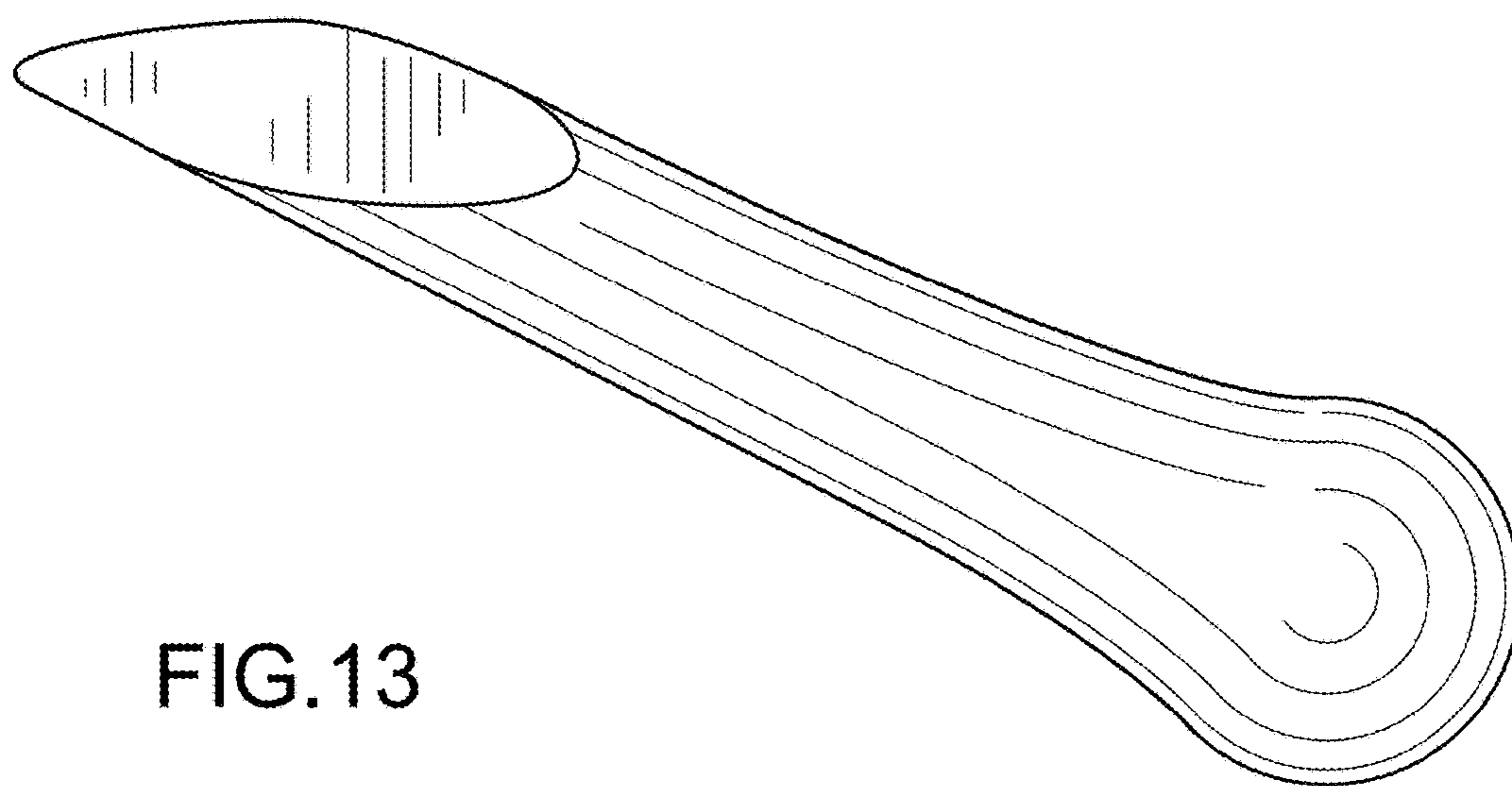

FIG.13

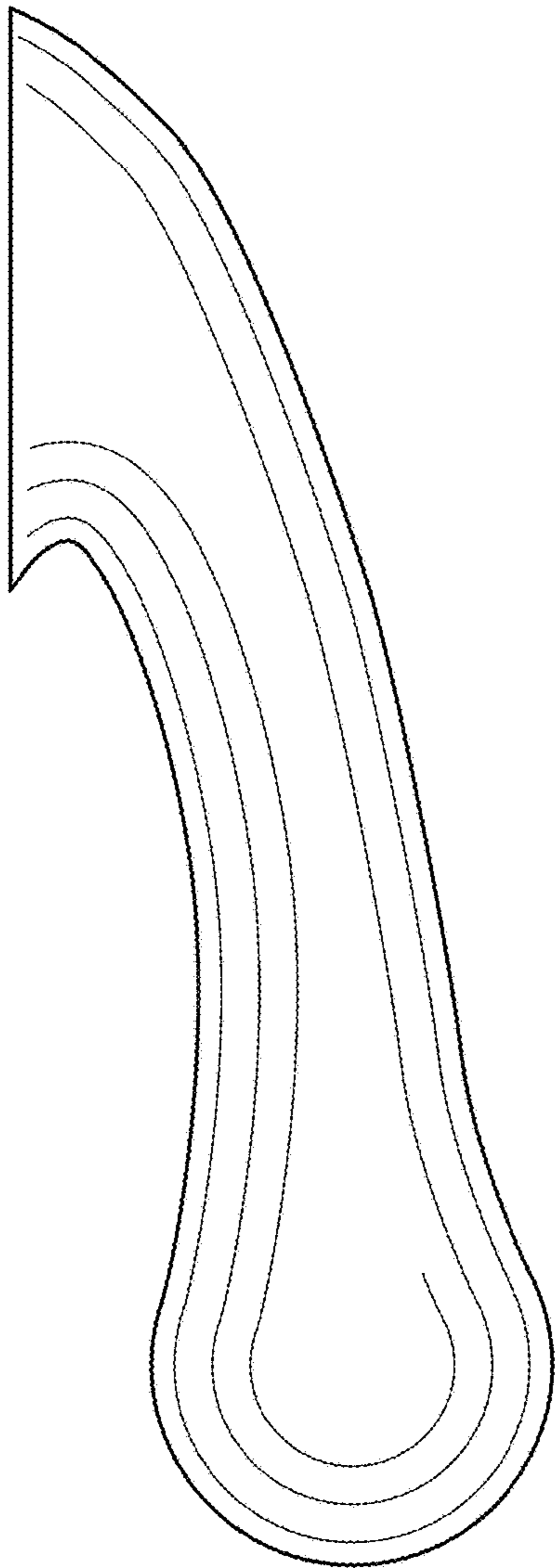

FIG.14

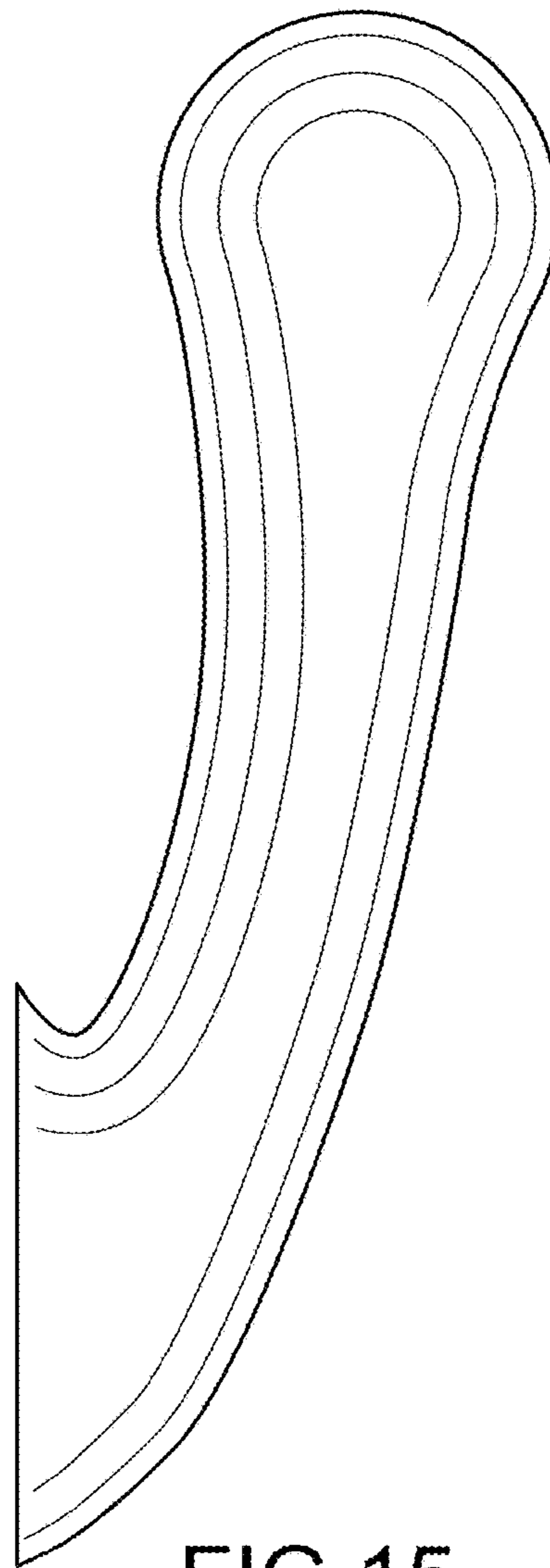

FIG.15

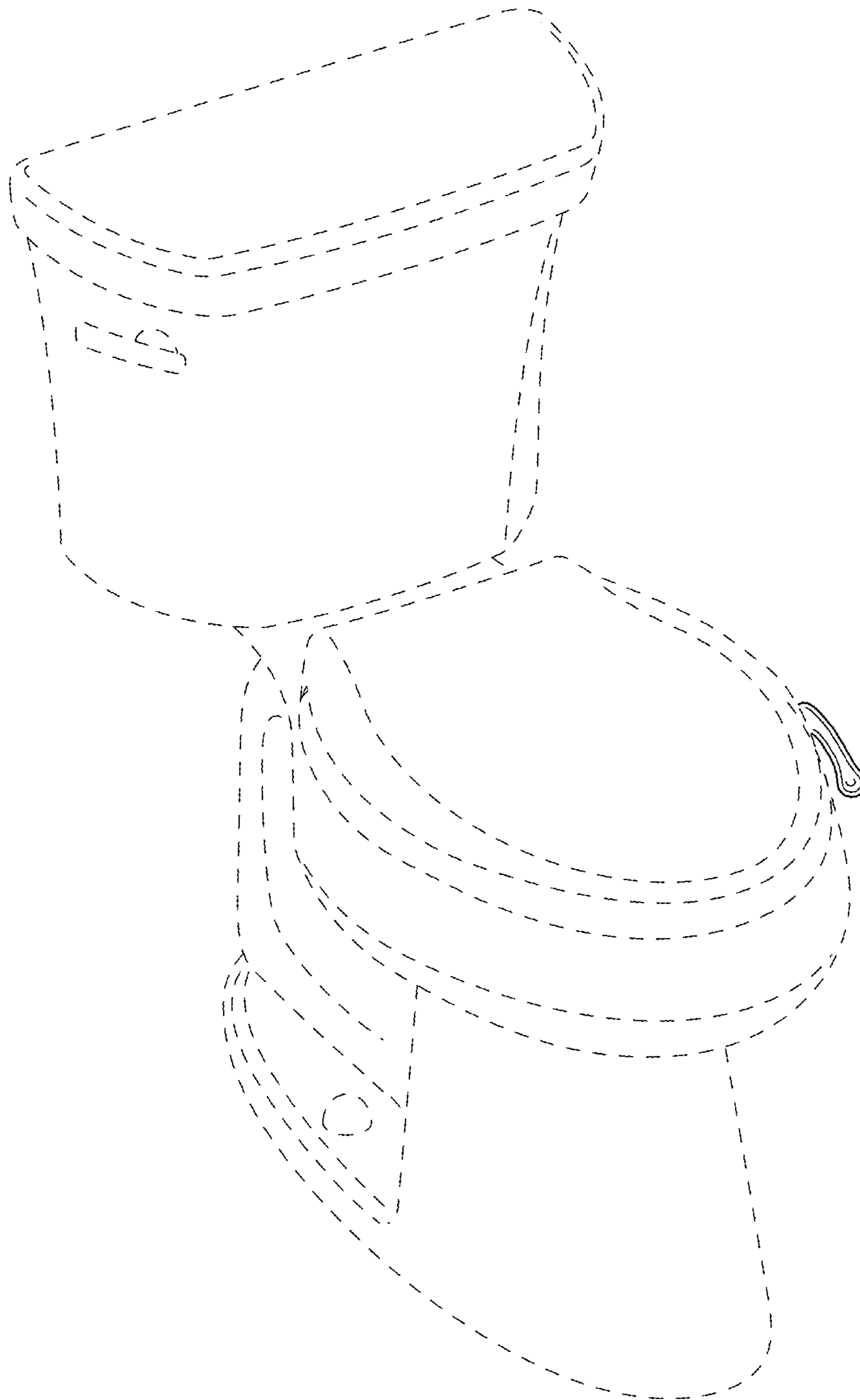

FIG.16