



US00D826609S

(12) **United States Design Patent**
Sater

(10) **Patent No.:** **US D826,609 S**

(45) **Date of Patent:** **** Aug. 28, 2018**

(54) **MULTI-PILLAR STRUCTURE**

(71) Applicant: **EDDI, INC.**, Chino, CA (US)

(72) Inventor: **Ash Sater**, Chino, CA (US)

(73) Assignee: **Eddi, Inc.**, Chino, CA (US)

(**) Term: **15 Years**

(21) Appl. No.: **29/604,488**

(22) Filed: **May 17, 2017**

(51) **LOC (11) Cl.** **06-03**

(52) **U.S. Cl.**

USPC **D6/709.19; D6/708.15**

(58) **Field of Classification Search**

USPC D6/336, 353, 368, 555, 641, 655, 655.1,
D6/663, 664, 657, 672, 675, 675.1, 675.3,
D6/686, 687, 688.11, 688.19, 691, 691.1,
D6/691.7, 691.9, 692, 692.2, 692.5,
D6/692.6, 707, 707.12, 707.18, 707.19,
D6/707.2, 708, 708.15, 708.16, 708.17,
D6/708.24, 709-709.22

CPC .. A47B 37/00; A47B 3/00; A47B 1/00; A47B
3/06; A47B 3/08; A47B 7/00; A47B
21/00; A47B 23/00; A47B 25/00; A47B
13/08; A47B 3/083; A47B 3/14; A47B
41/00; A47B 17/00; A47B 3/0809; A47B
3/0812; A47B 2013/026; A47B 2200/03;
A47B 2200/00; A47B 2003/0821; A47C
3/045

See application file for complete search history.

(56) **References Cited**

U.S. PATENT DOCUMENTS

3,364,704 A * 1/1968 Bernstein F21S 13/10
219/201
4,650,143 A * 3/1987 Kurrasch A47B 9/04
108/144.11

D456,541 S * 4/2002 Yeh D26/8
D463,322 S * 9/2002 LoVullo D11/149
D464,156 S * 10/2002 Yeh D26/8

(Continued)

OTHER PUBLICATIONS

Olander Coffee Table, posted at Wayfair.com, posted on Sep. 24, 2015, site visited Jul. 9, 2018. online, available from internet: https://www.wayfair.com/furniture/pdp/willa-arlo-interiors-olander-coffee-table-wlao2064.html?piid=0.*

(Continued)

Primary Examiner — Mary Ann Calabrese

Assistant Examiner — Catherine Ho

(74) *Attorney, Agent, or Firm* — Loza & Loza, LLP;
Heidi Eisenhut

(57)

CLAIM

The ornamental design for a multi-pillar structure, as shown and described.

DESCRIPTION

FIG. 1 is a front top left side perspective view of the first embodiment of a multi-pillar structure, showing my new design;

FIG. 2 is a first side elevation view thereof, the second side being a mirror image thereof;

FIG. 3 is a front elevation view thereof, a back elevation view

FIG. 4 is a bottom plan view thereof;

FIG. 5 is a front top left side perspective view of the second embodiment of a multi-pillar structure;

FIG. 6 is a first side elevation view thereof, a second side being a mirror image thereof;

FIG. 7 is a front elevation view thereof, a back elevation view being a mirror image thereof; and,

FIG. 8 is a bottom plan view thereof.

The broken line portion of the figure drawings is included to show portions of the article that form no part of the claimed design.

1 Claim, 8 Drawing Sheets

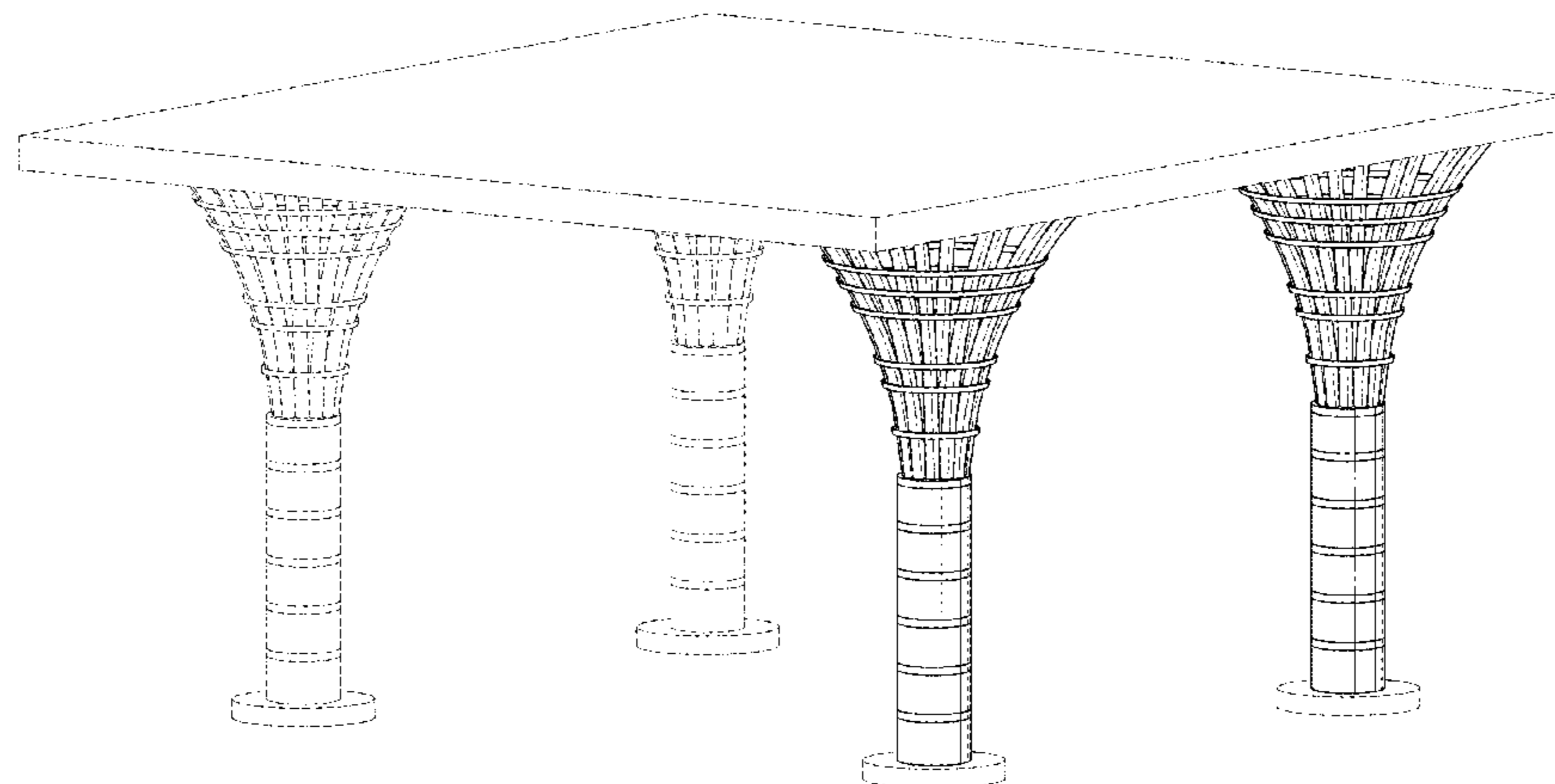

(56)

References Cited

U.S. PATENT DOCUMENTS

D464,447 S * 10/2002 Yeh D26/8
D646,913 S * 10/2011 Navone D6/689

OTHER PUBLICATIONS

Alburg Coffee Table, posted at Wayfair.com, posted on Feb. 6, 2017, site visited Jul. 9, 2018. online, available from internet: <https://www.wayfair.com/furniture/pdp/bay-isle-home-alburg-coffee-table-bayi4571.html?piid=0>.*

Bali Hai Dining Table, posted at Wayfair.com, posted on Sep. 1, 2016, site visited Jul. 9, 2018. online, available from internet: https://tineye.com/search/3e31750a84048c0001502650068317cc81654110/?extension_ver=chrome-1.2.0.*

* cited by examiner

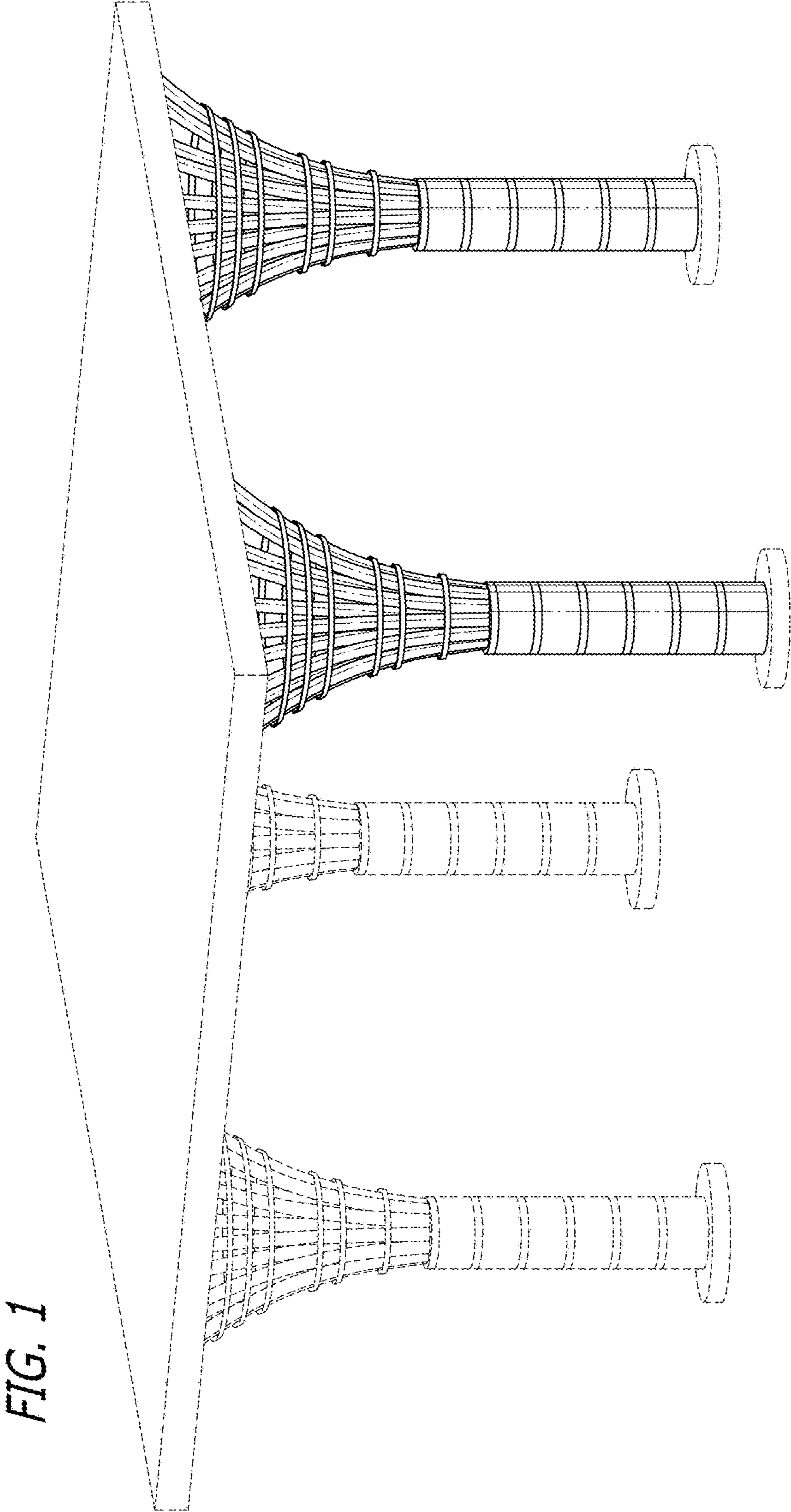

FIG. 1

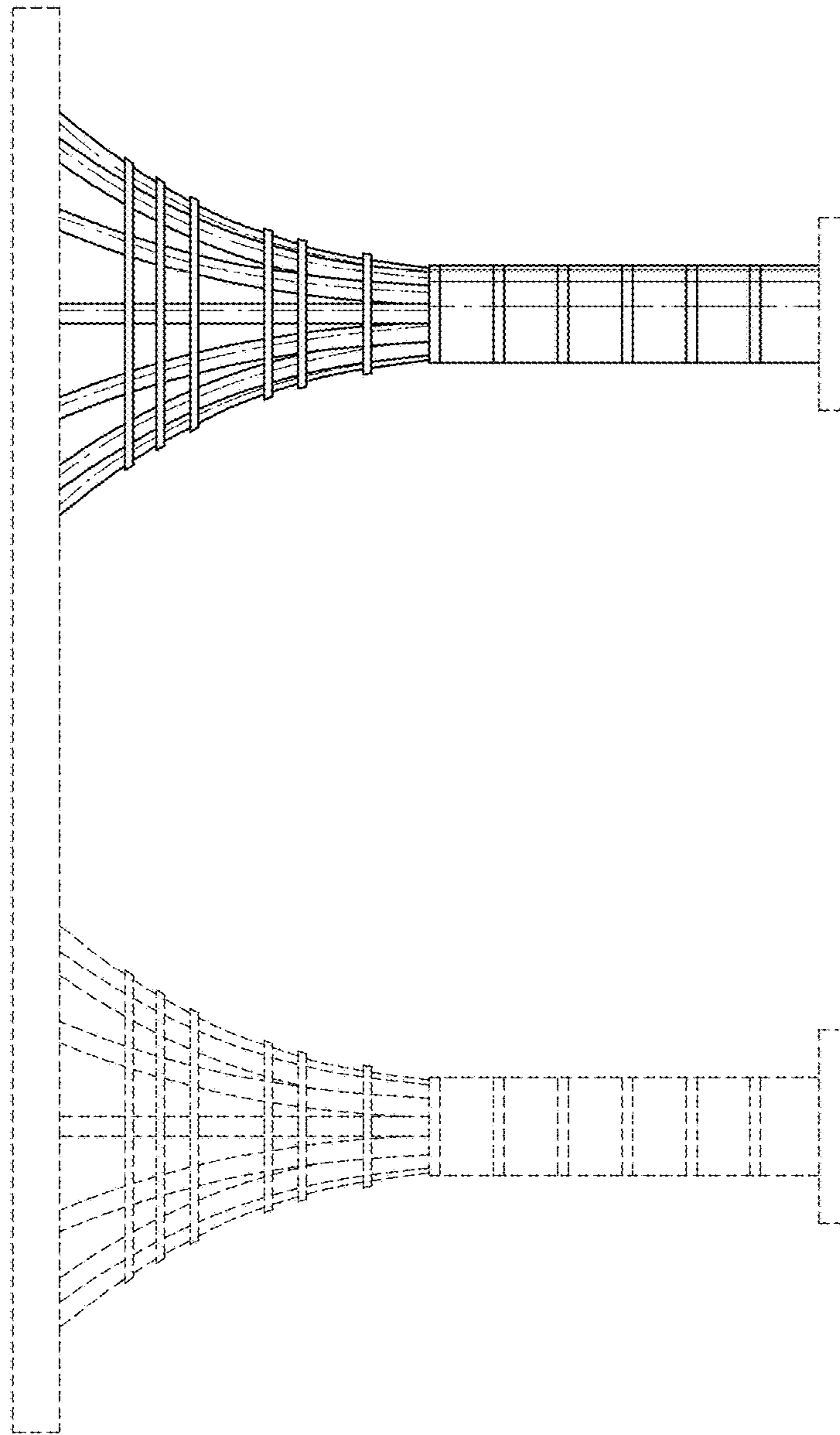

FIG. 2

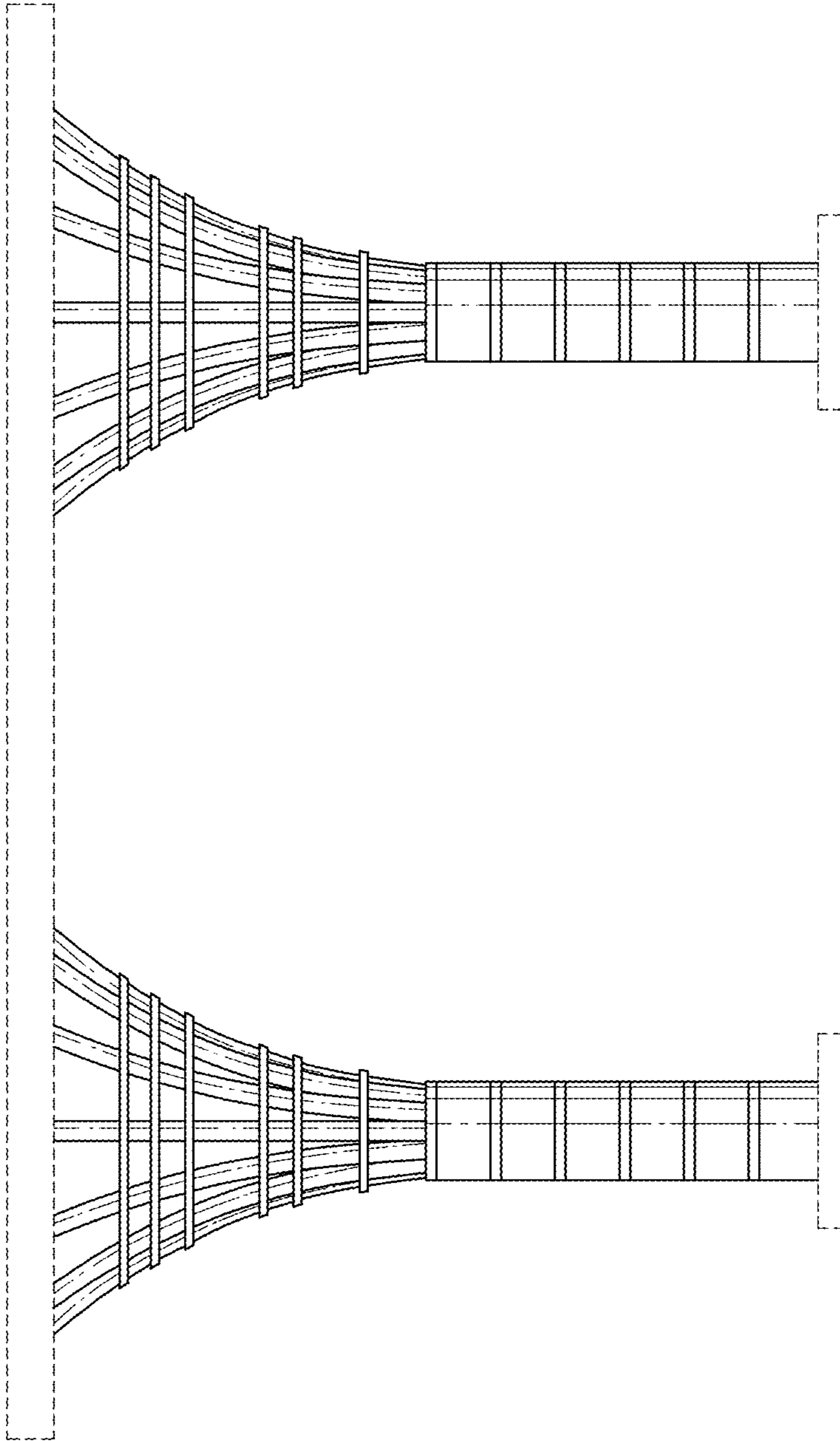
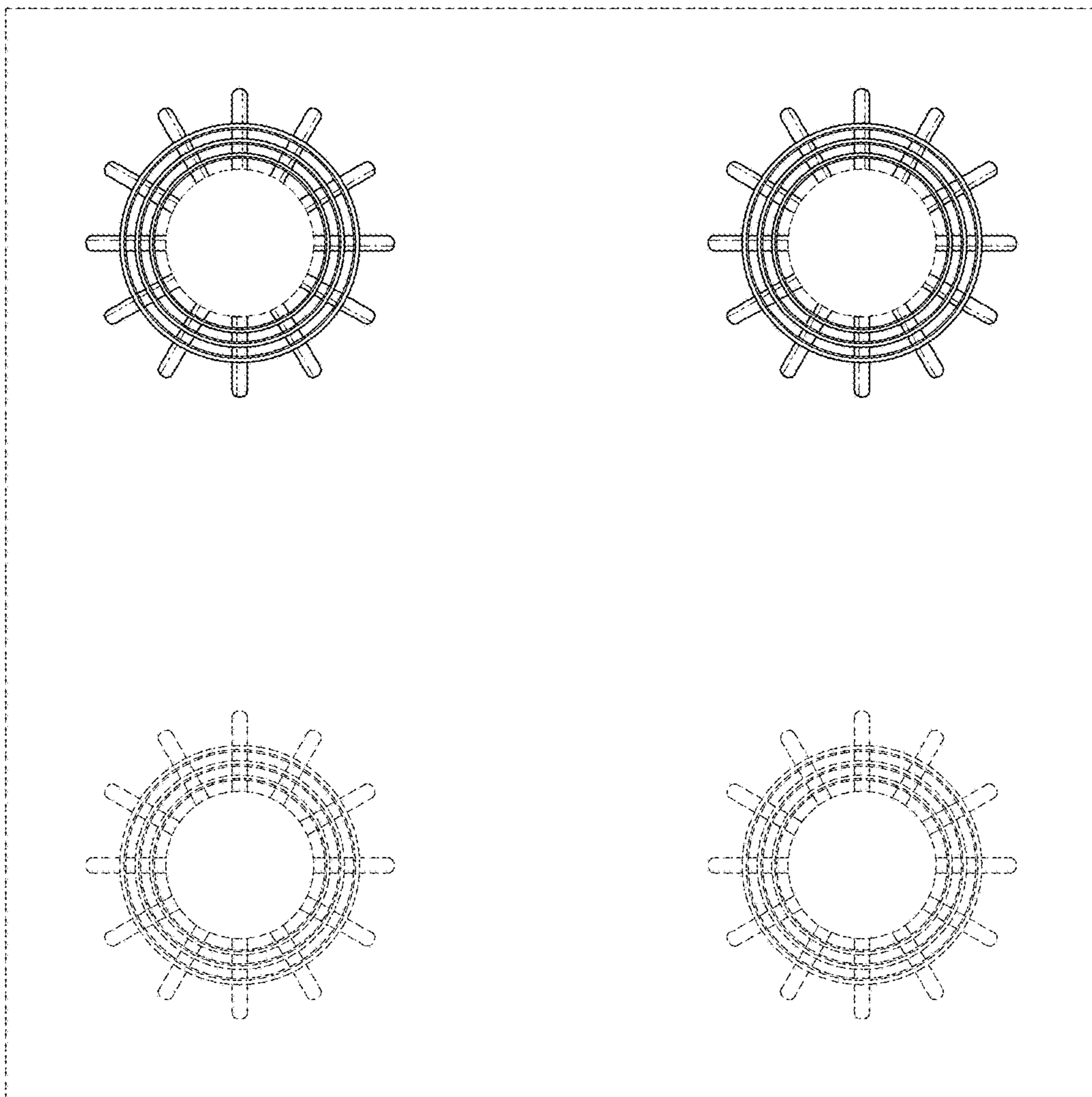
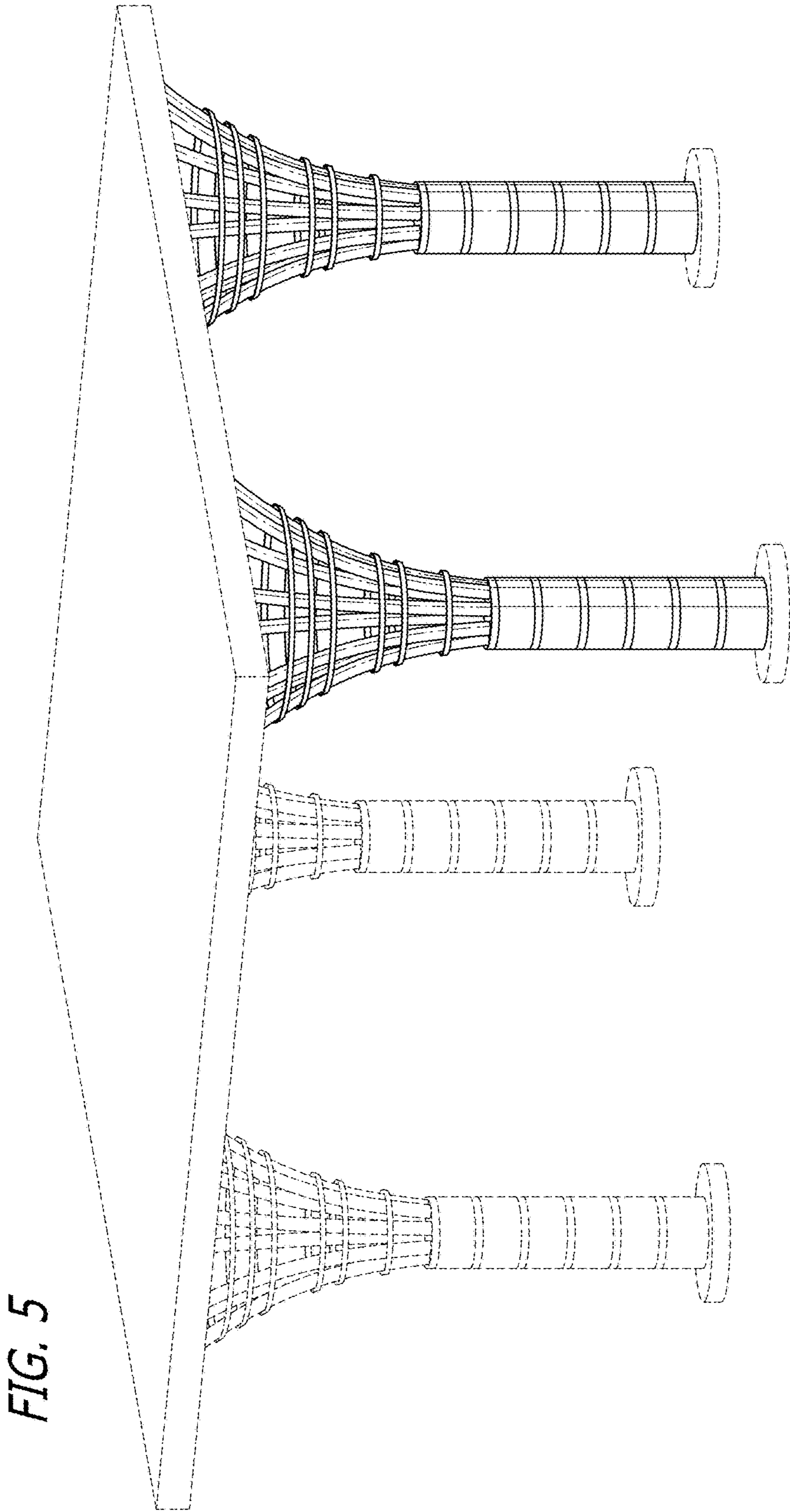

FIG. 3

FIG. 4





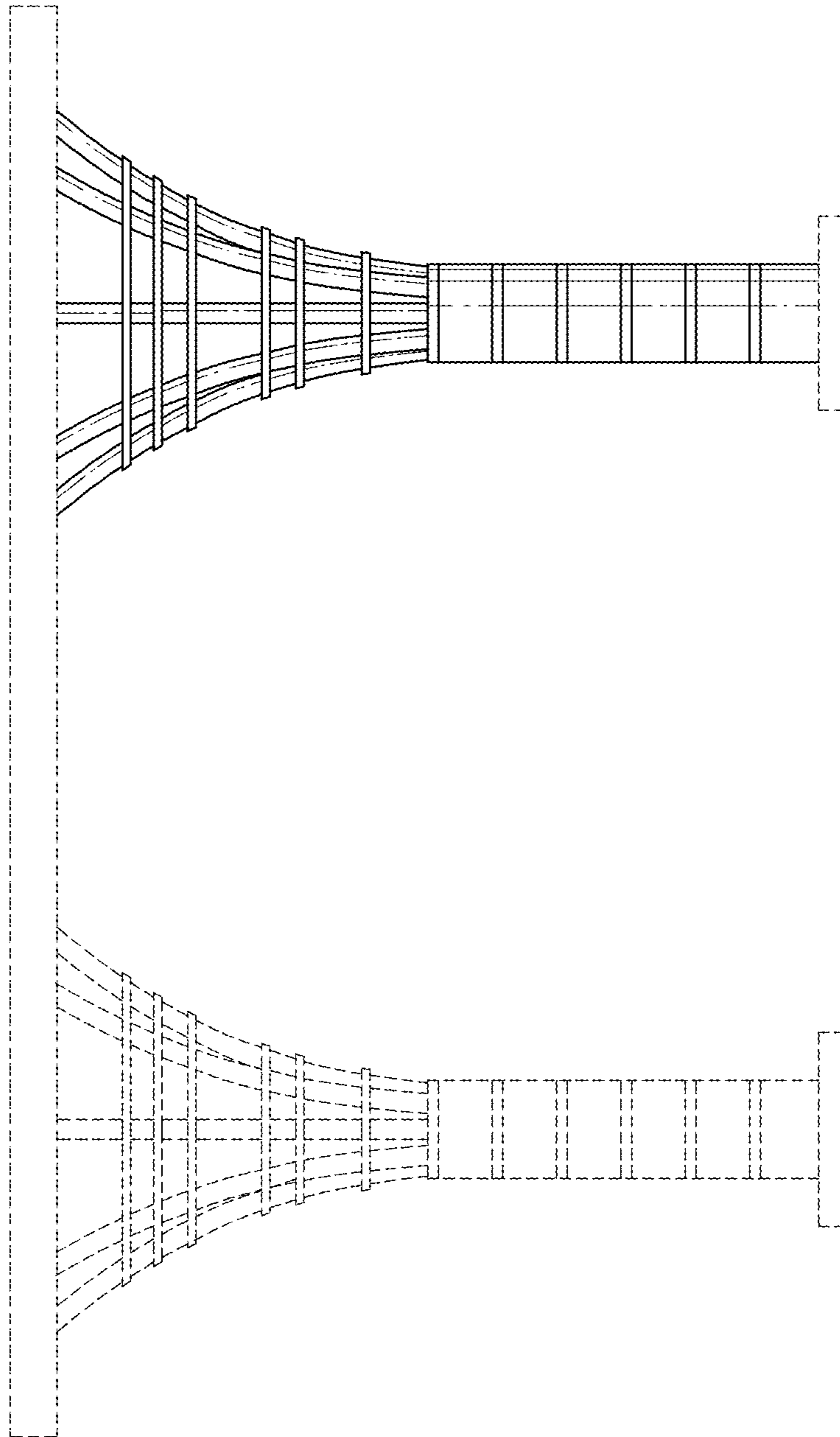

FIG. 6

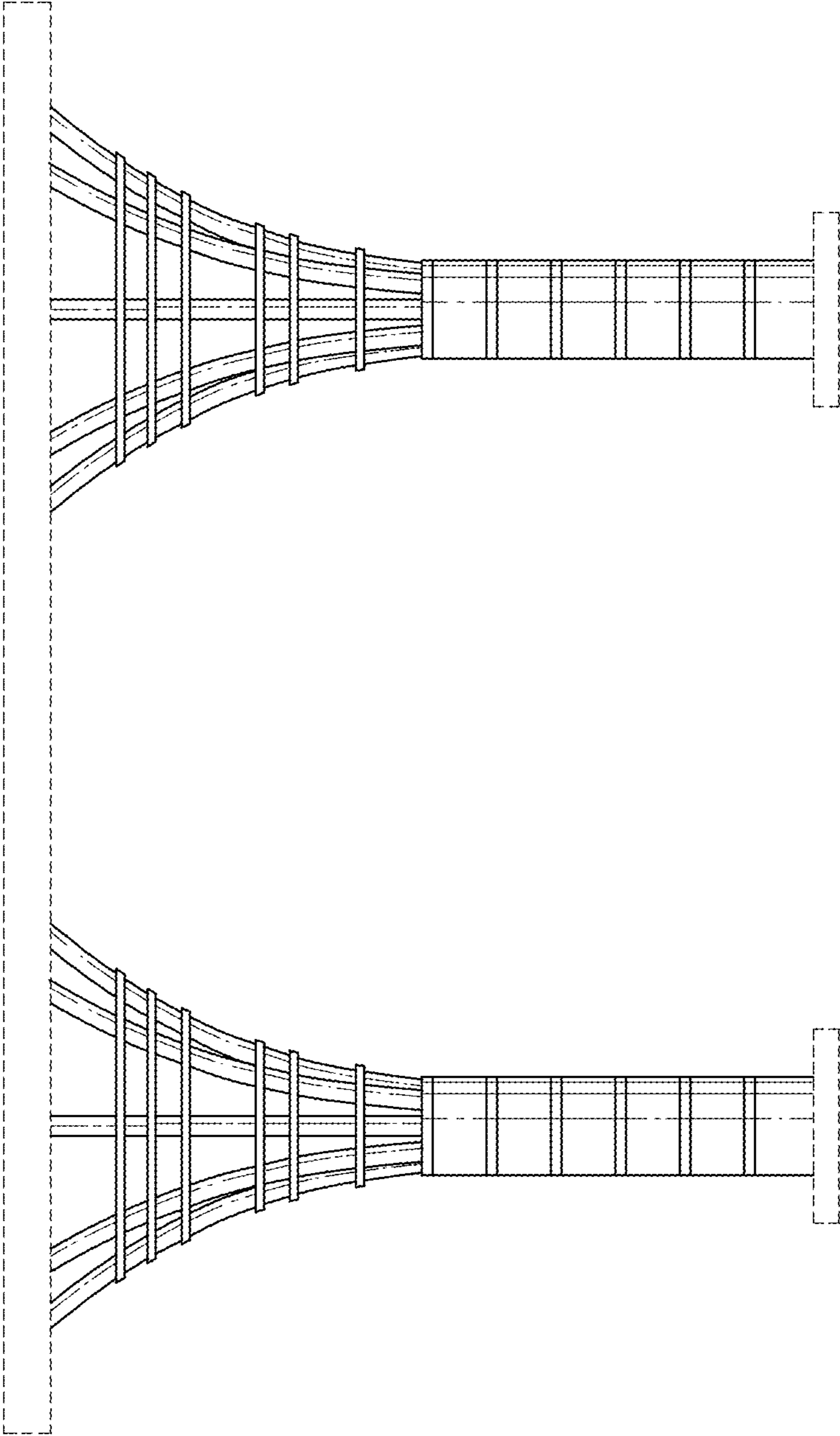

FIG. 7

FIG. 8

