

US00D826597S

(12) **United States Design Patent**
Miura et al.

(10) **Patent No.:** **US D826,597 S**

(45) **Date of Patent:** **** Aug. 28, 2018**

- (54) **HEADREST FOR A BATHTUB**
- (71) Applicant: **TOTO, Ltd.**, Kitakyushu-shi, Fukuoka (JP)
- (72) Inventors: **Osamu Miura**, Kitakyushu (JP); **Yuji Yoshioka**, Kitakyushu (JP)
- (73) Assignee: **TOTO, Ltd.**, Kitakyushu-shi, Fukuoka (JP)

6,357,061 B1 * 3/2002 Gonzalez A47K 3/12
4/580
D456,660 S * 5/2002 Landvik D6/601
6,502,253 B1 * 1/2003 Olney A47K 3/125
4/541.1
D481,242 S * 10/2003 Peterson D6/601
D577,943 S * 10/2008 Larsen D6/601
D597,638 S * 8/2009 Lebrun D6/601
D615,794 S * 5/2010 Jorgensen D6/601
D726,450 S * 4/2015 Wootten, Jr. D6/601

* cited by examiner

- (**) Term: **15 Years**
- (21) Appl. No.: **29/616,036**
- (22) Filed: **Sep. 1, 2017**

Primary Examiner — Robert A Delehanty
(74) *Attorney, Agent, or Firm* — Banner & Witcoff, Ltd.

(30) **Foreign Application Priority Data**

Mar. 7, 2017 (TW) 106301118

- (51) **LOC (11) Cl.** **06-09**
- (52) **U.S. Cl.**
USPC **D6/601**
- (58) **Field of Classification Search**
USPC D6/601; D23/303–304; D24/204–205
See application file for complete search history.

(57) **CLAIM**

The ornamental design for a headrest for a bathtub, as shown and described.

DESCRIPTION

FIG. 1 is a front perspective view of a headrest for a bathtub showing our new design;
FIG. 2 is a rear perspective view thereof;
FIG. 3 is a front view thereof;
FIG. 4 is a rear view thereof;
FIG. 5 is a right side view thereof, the left side view being a mirror image;
FIG. 6 is a top view thereof; and,
FIG. 7 is a bottom view thereof.
The broken lines shown in the drawings illustrate portions of the bathtub that form no part of the claimed design.

(56) **References Cited**

U.S. PATENT DOCUMENTS

D316,354 S * 4/1991 Bool D6/601
D364,303 S * 11/1995 Larsen D6/601

1 Claim, 6 Drawing Sheets

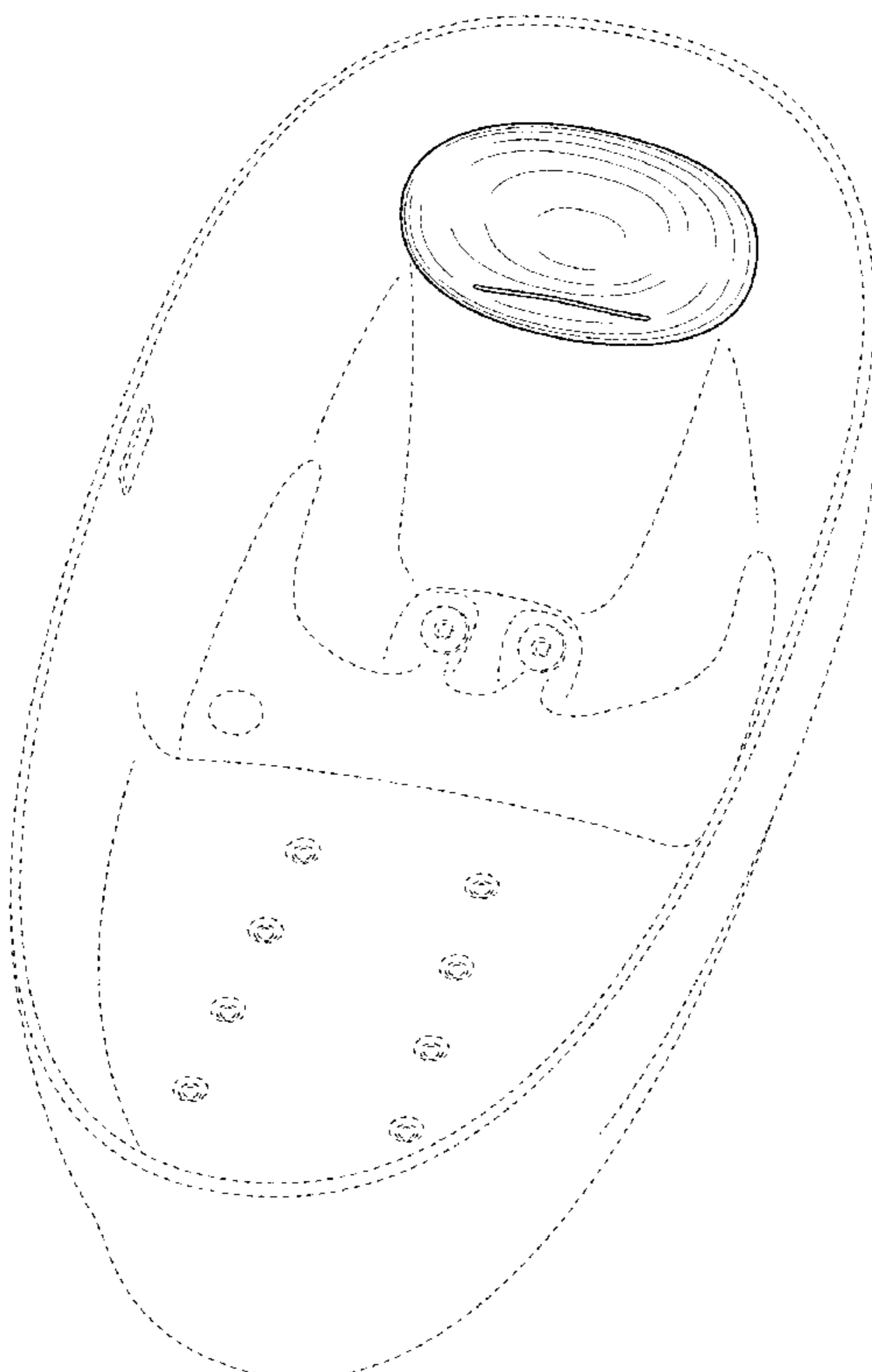

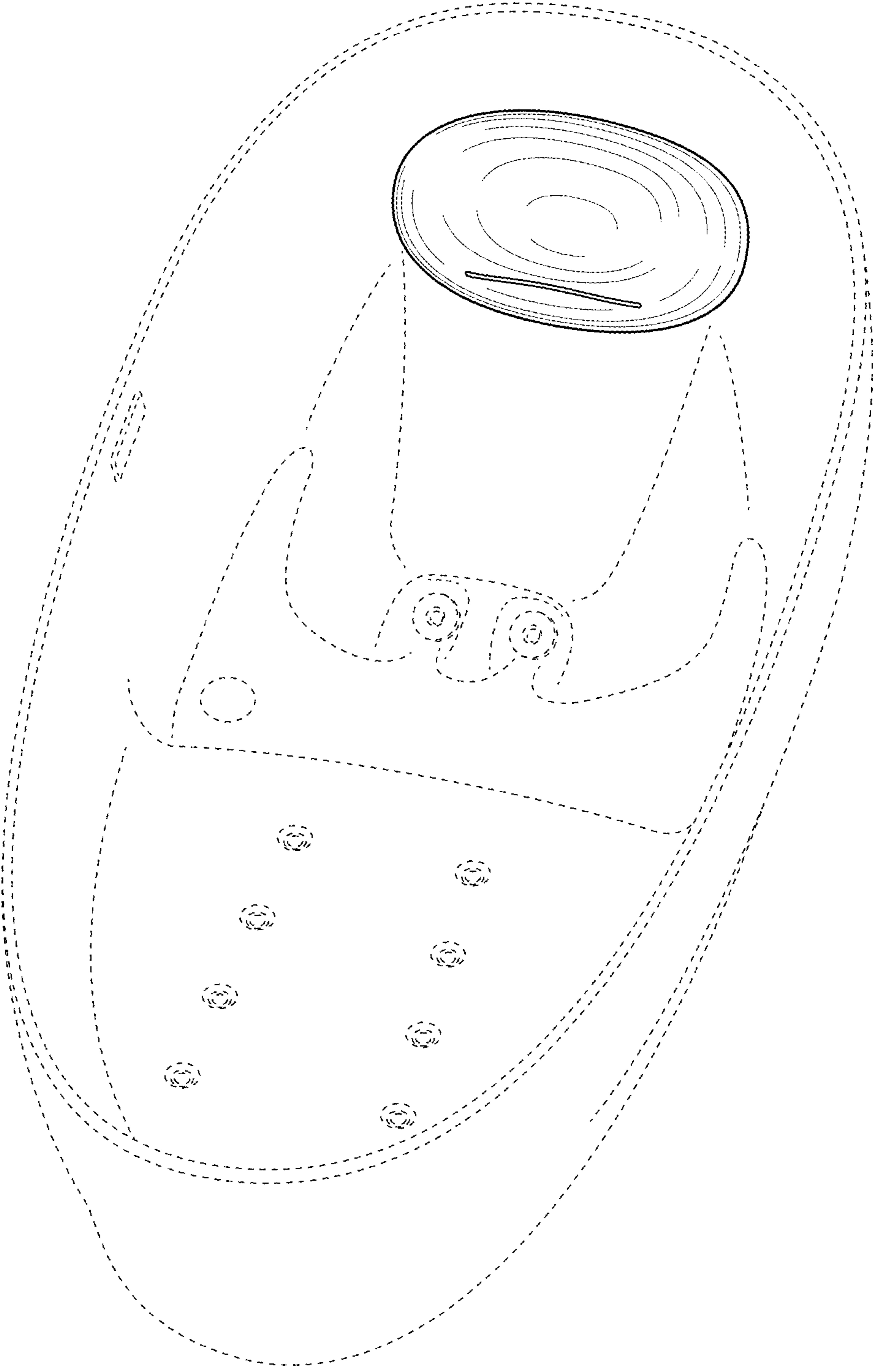

FIG. 1

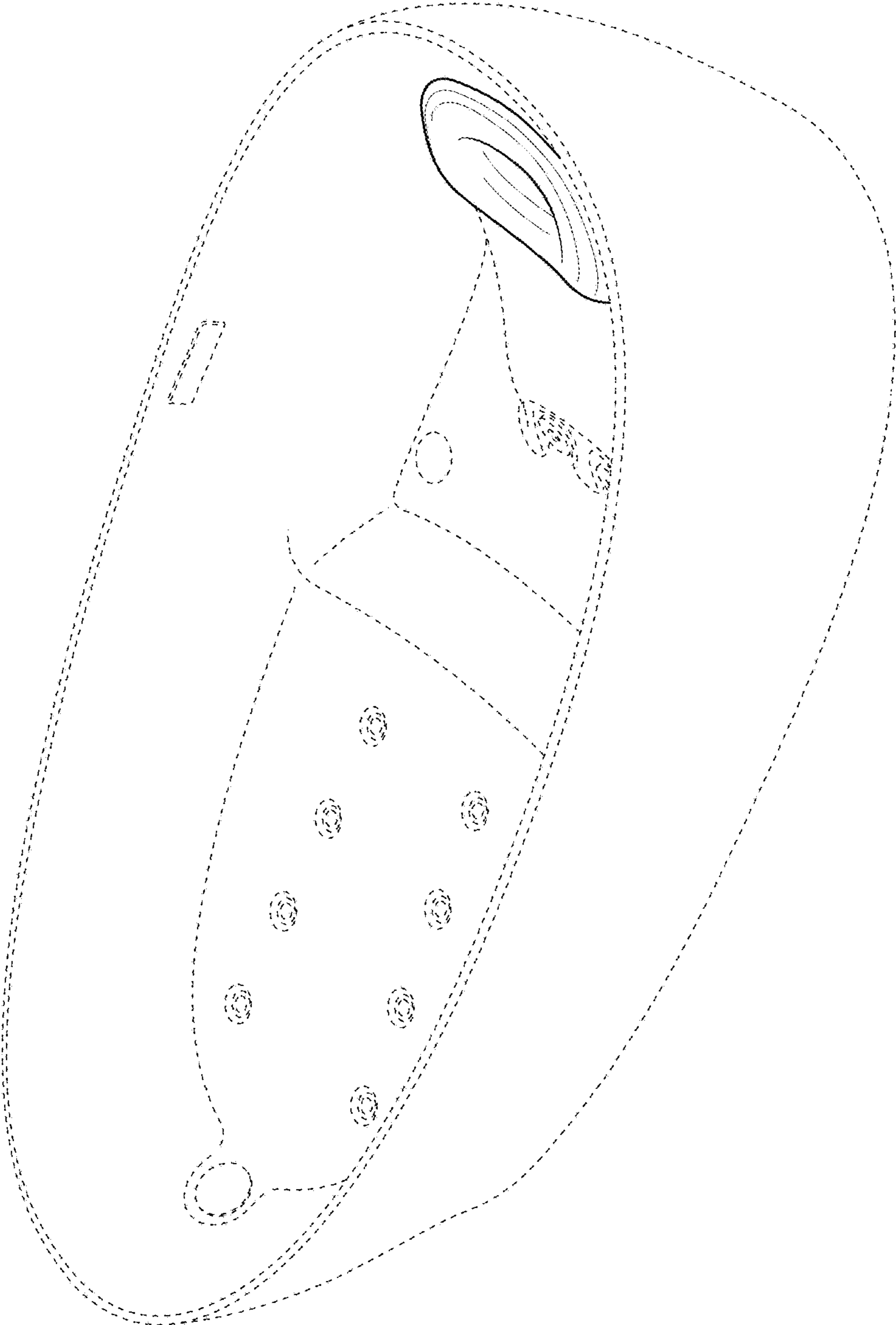

FIG. 2

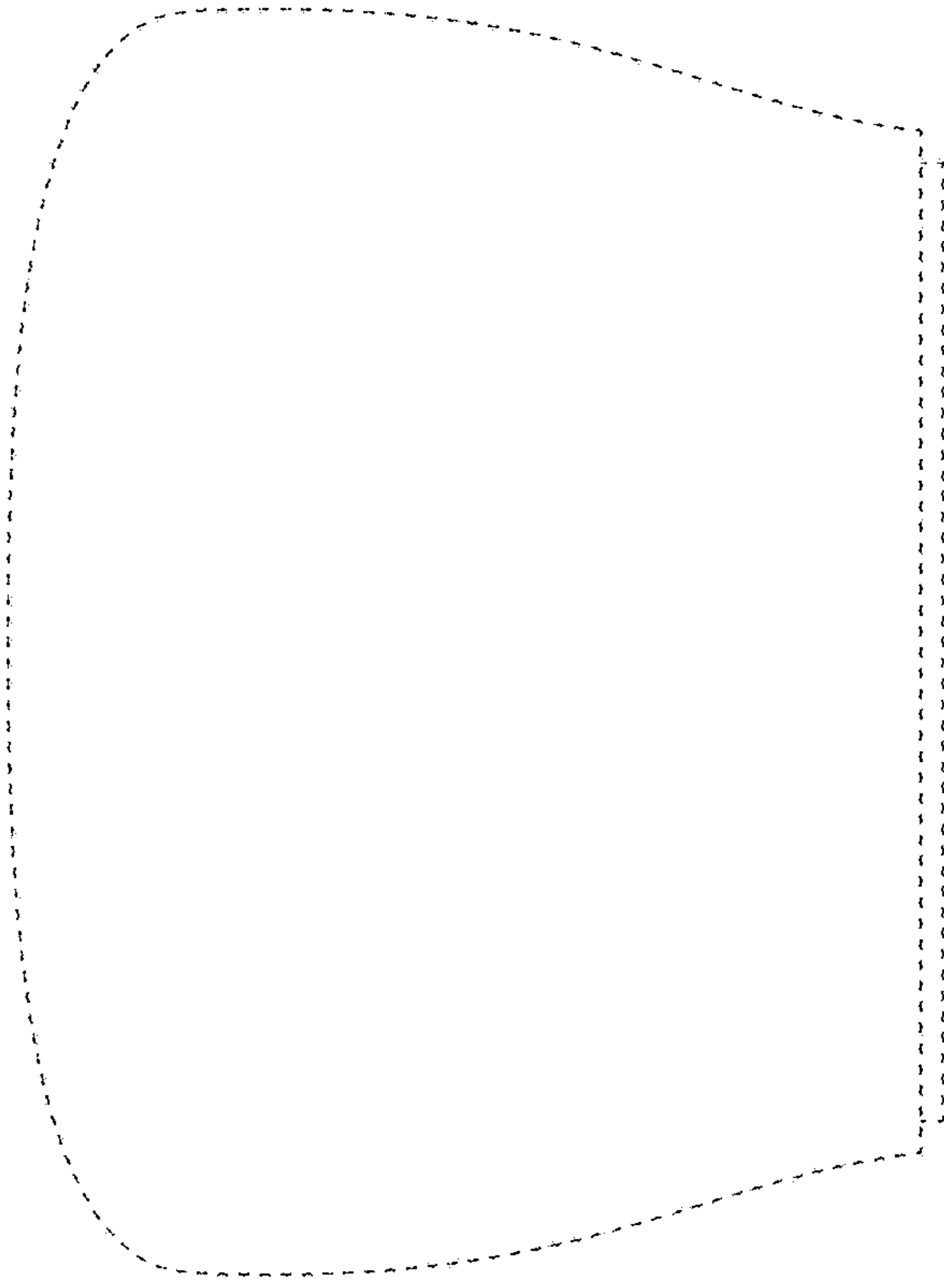

FIG. 4

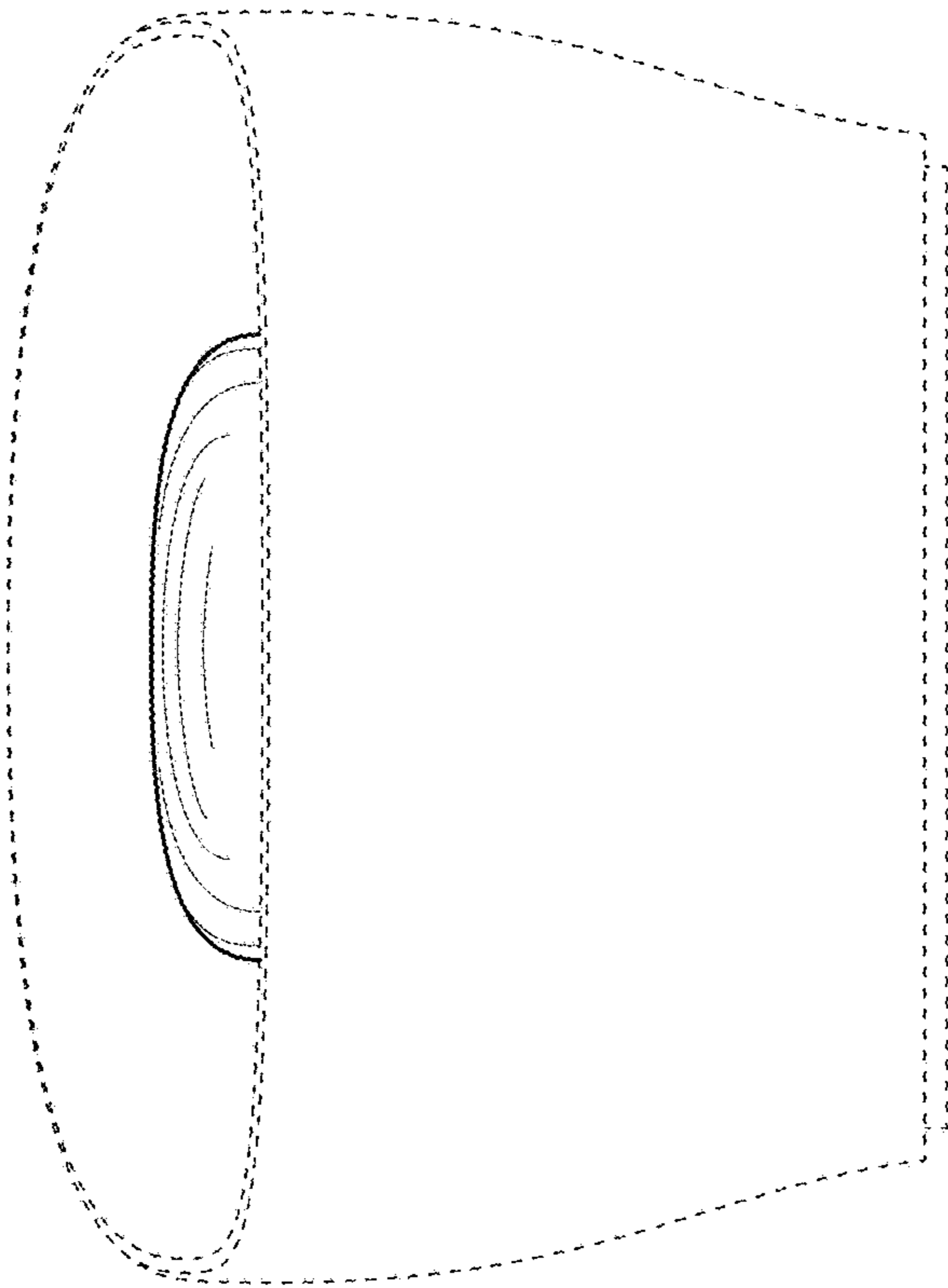

FIG. 3

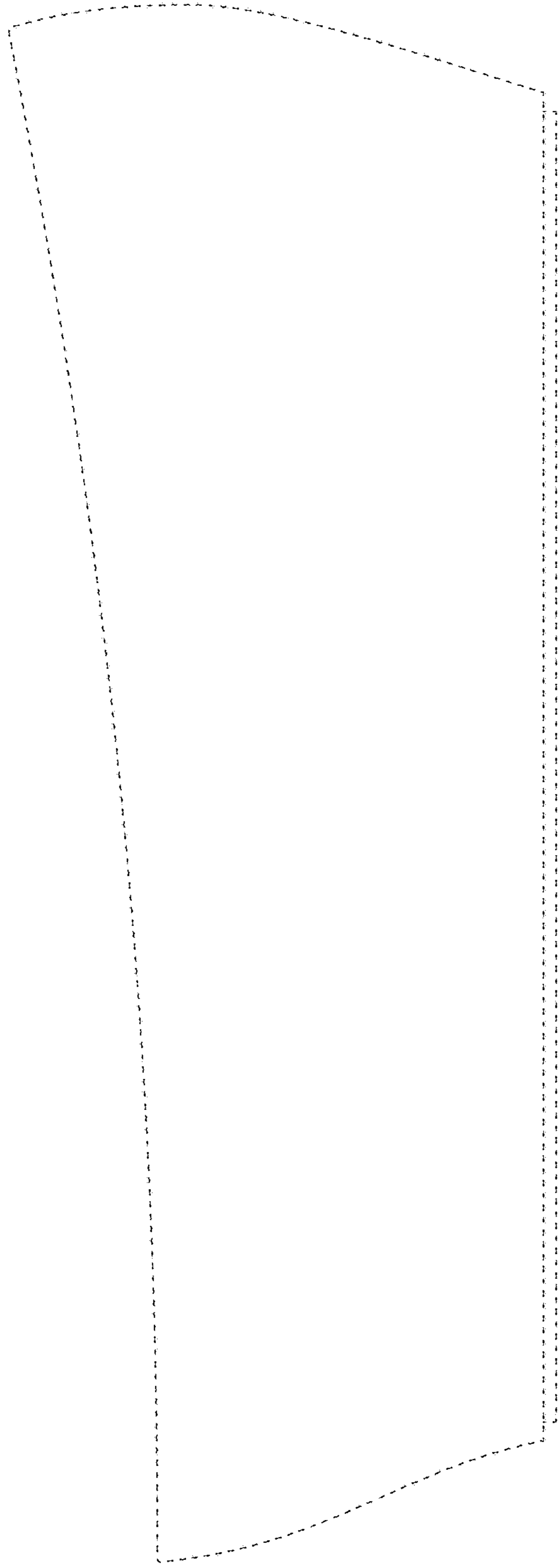

FIG. 5

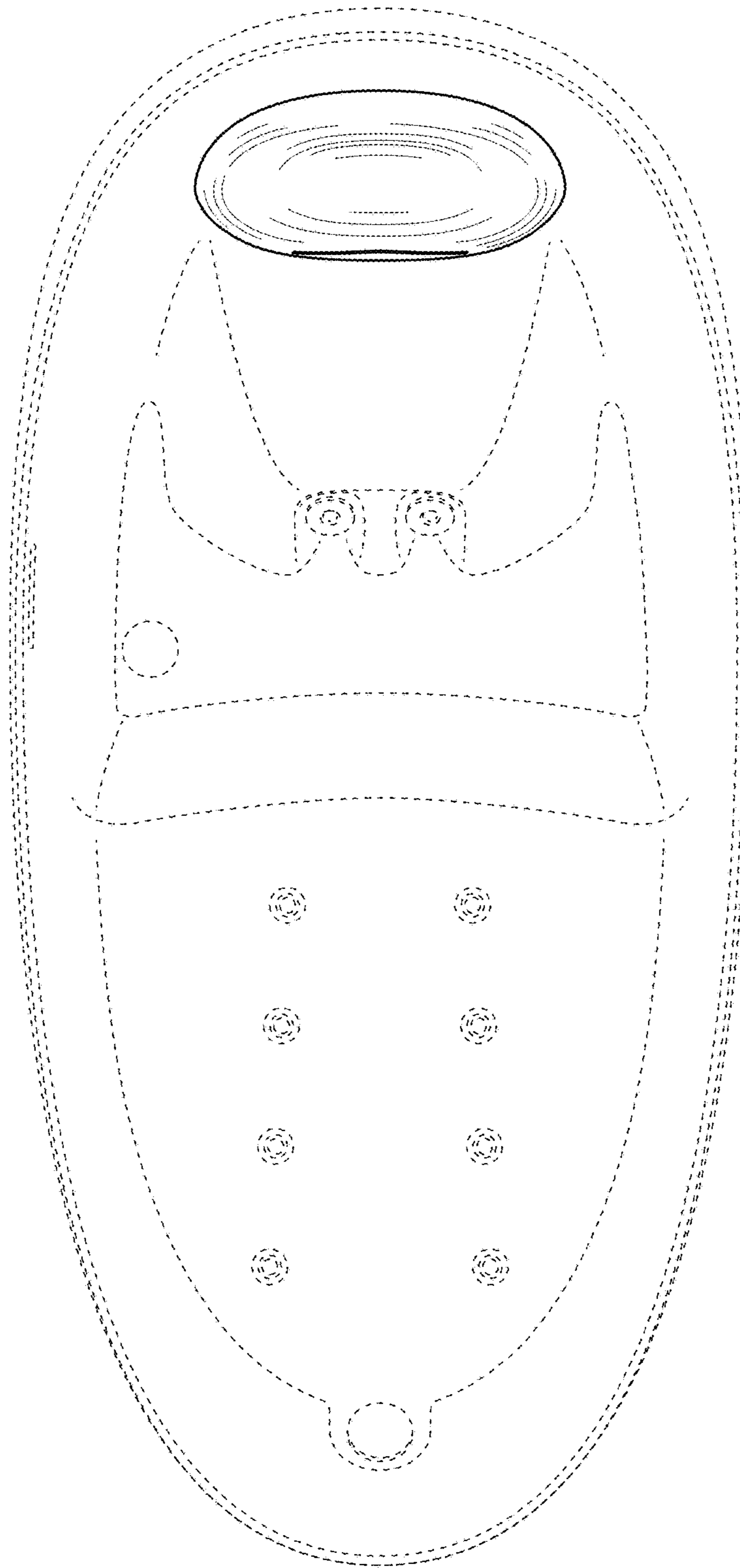

FIG. 6

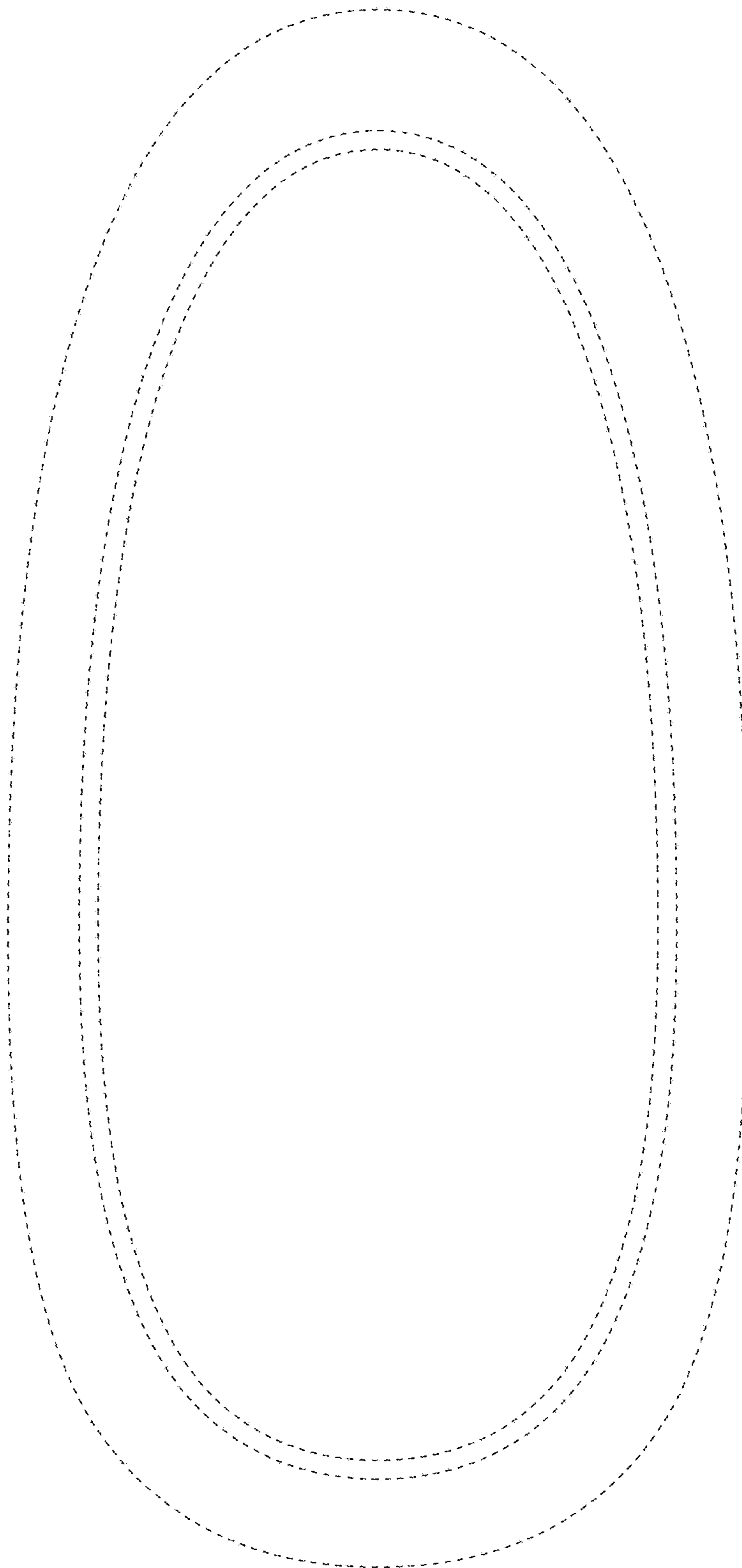

FIG. 7