

US00D826537S

(12) **United States Design Patent** (10) **Patent No.:** **US D826,537 S**
Petrie (45) **Date of Patent:** **** Aug. 28, 2018**

(54) **SHOE UPPER**
(71) Applicant: **NIKE, Inc.**, Beaverton, OR (US)
(72) Inventor: **Jason G. Petrie**, Portland, OR (US)
(73) Assignee: **NIKE, Inc.**, Beaverton, OR (US)
(**) Term: **15 Years**

D667,211 S 9/2012 Shaffer
D707,950 S 7/2014 William, Jr.
D709,684 S * 7/2014 Hlavacs D2/969
D712,130 S * 9/2014 Lonigan D2/969
D712,647 S * 9/2014 Portzline D2/969
D765,383 S 9/2016 Chang
D769,600 S 10/2016 Avar
D778,572 S 2/2017 Kirschner
D778,589 S 2/2017 Hui

(21) Appl. No.: **29/599,665**
(22) Filed: **Apr. 5, 2017**
(51) **LOC (11) Cl.** **02-99**
(52) **U.S. Cl.**
USPC **D2/972**; D2/946
(58) **Field of Classification Search**
USPC D2/902, 906-908, 923, 944, 946, 969,
D2/972-975, 978; D5/46, 47, 49, 53
CPC ... A43B 13/181; A43B 13/141; A43B 13/186;
A43B 13/188; A43B 23/00; A43B 23/02;
A43B 5/00; A43B 23/26; A43B 1/04;
A43B 11/14; A43B 7/00; A43B 3/12;
A43C 3/00; A43C 5/00; A43C 7/00;
A43C 11/004
See application file for complete search history.

OTHER PUBLICATIONS

Nike Air Zoom KD9 Reflects Basketballs Progression [online], [retrieved Apr. 3, 2017], Retrieved from Internet <URL: <http://news.nike.com/news/kevin-durant-kd9-flyknit>>; 5 color sheets, Dated Mar. 16, 2016.

(Continued)

Primary Examiner — Dominic V Simone
(74) *Attorney, Agent, or Firm* — Banner & Witcoff, Ltd.

(57) **CLAIM**

The ornamental design for a shoe upper, as shown and described.

DESCRIPTION

FIG. 1 is a front perspective view of a shoe upper showing my new design;
FIG. 2 is a side view thereof;
FIG. 3 is an opposite side view thereof;
FIG. 4 is a front view thereof;
FIG. 5 is a rear view thereof; and,
FIG. 6 is a top view thereof.
The broken lines immediately adjacent to the shaded area define the bounds of the claimed design and form no part thereof. The broken lines showing the remainder of the shoe represent unclaimed subject matter and form no part of the claimed design.

1 Claim, 6 Drawing Sheets

(56) **References Cited**

U.S. PATENT DOCUMENTS

D424,291 S * 5/2000 Matis D2/902
D479,388 S * 9/2003 Matis D2/969
D503,524 S * 4/2005 Belley D2/969
D505,252 S * 5/2005 Belley D2/969
D514,299 S * 2/2006 Ardissono D2/969
D514,792 S * 2/2006 Ardissono D2/969
D533,987 S * 12/2006 Matis D2/969
D538,021 S * 3/2007 Matis D2/969
D546,041 S * 7/2007 Horne D2/969
D546,043 S * 7/2007 Belley D2/969
D547,535 S * 7/2007 Matis D2/969
D563,652 S * 3/2008 Matis D2/969

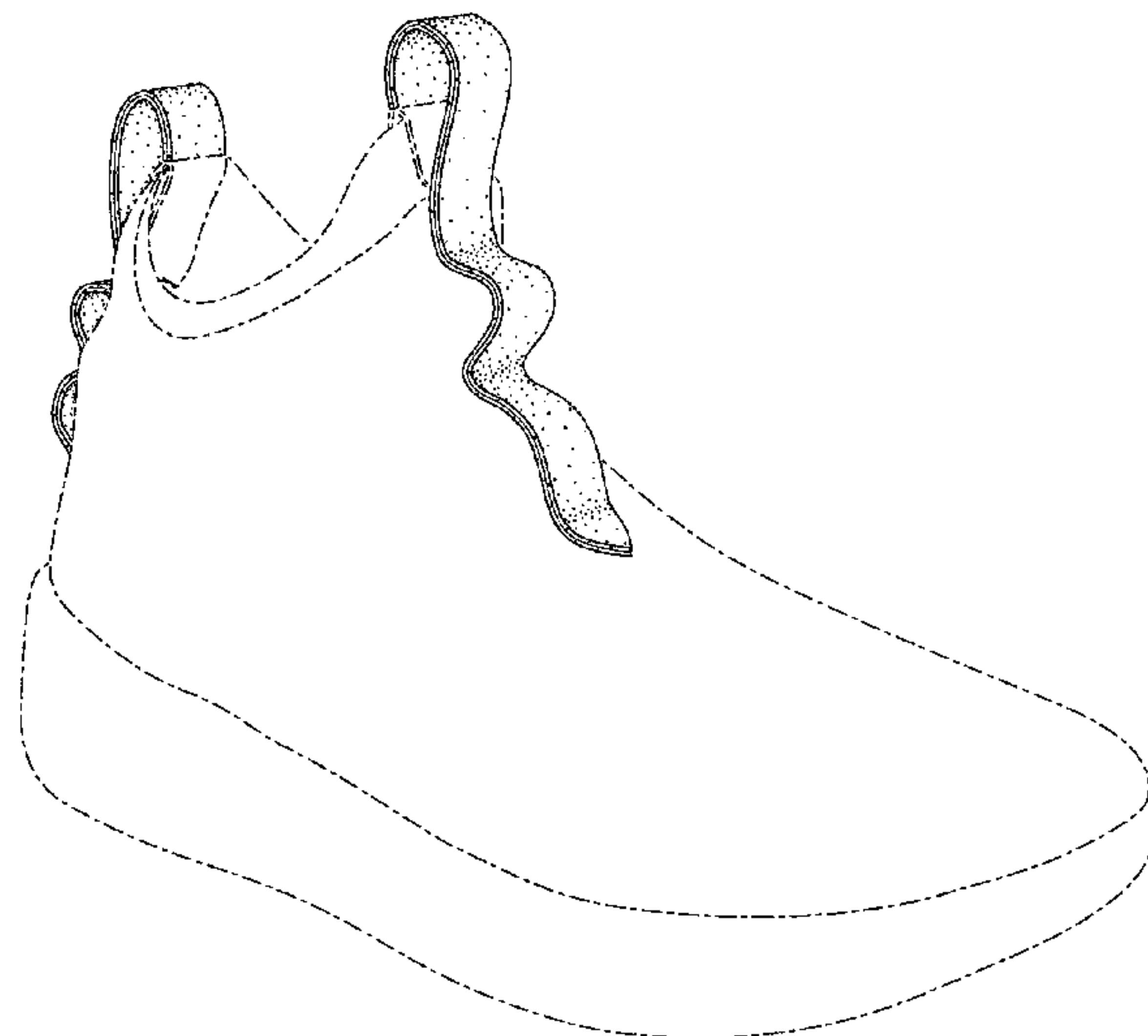

(56)

References Cited

OTHER PUBLICATIONS

Adidas Gives the Tubular Shadow a Quilted Makeover [online], [retrieved Apr. 3, 2017], Retrieved from Internet <URL: <https://hypebeast.com/2017/3/adidas-originals-tubular-shadow-quilted-clear-brown>>; 2 color sheets, Dated Mar. 21, 2017.

Nike Has a Brand New Lunar Training Sneaker Dropping This Year [online], [retrieved Apr. 4, 2017], Retrieved from Internet <URL: <http://www.complex.com/sneakers/2016/01/nike-lunar-stelos>>; 3 color sheets, Dated Jan. 1, 2016.

* cited by examiner

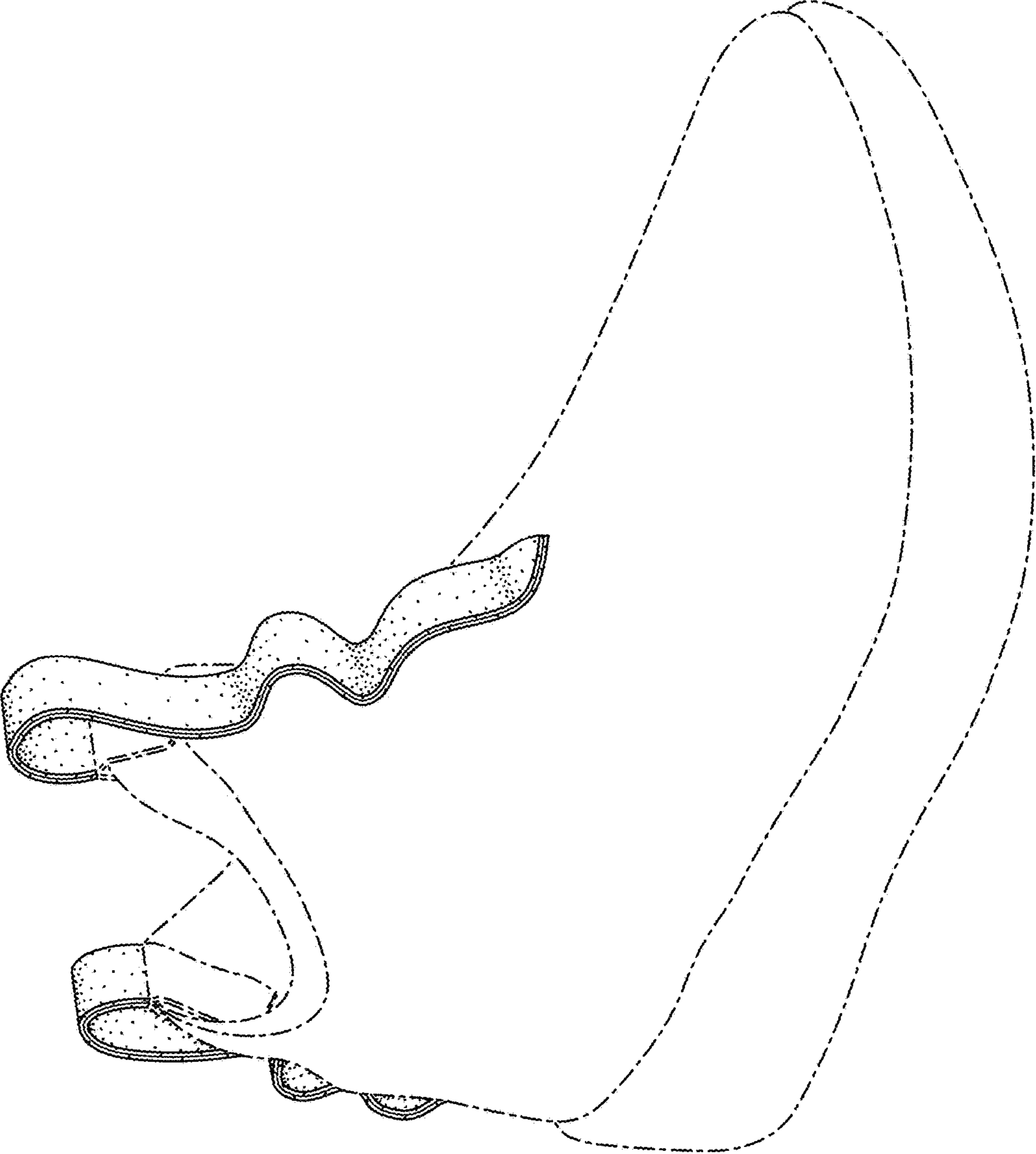

FIG. 1

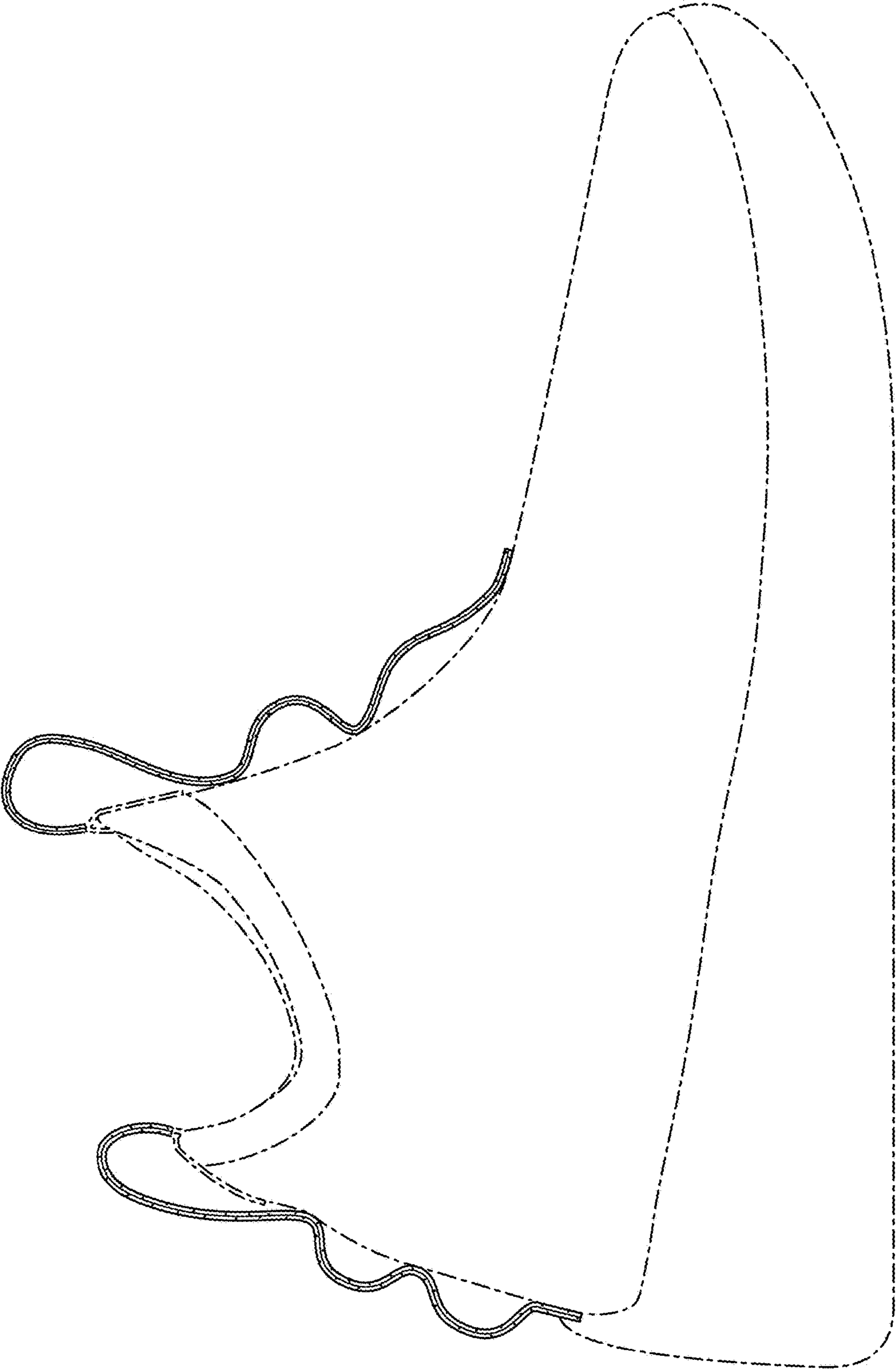

FIG. 2

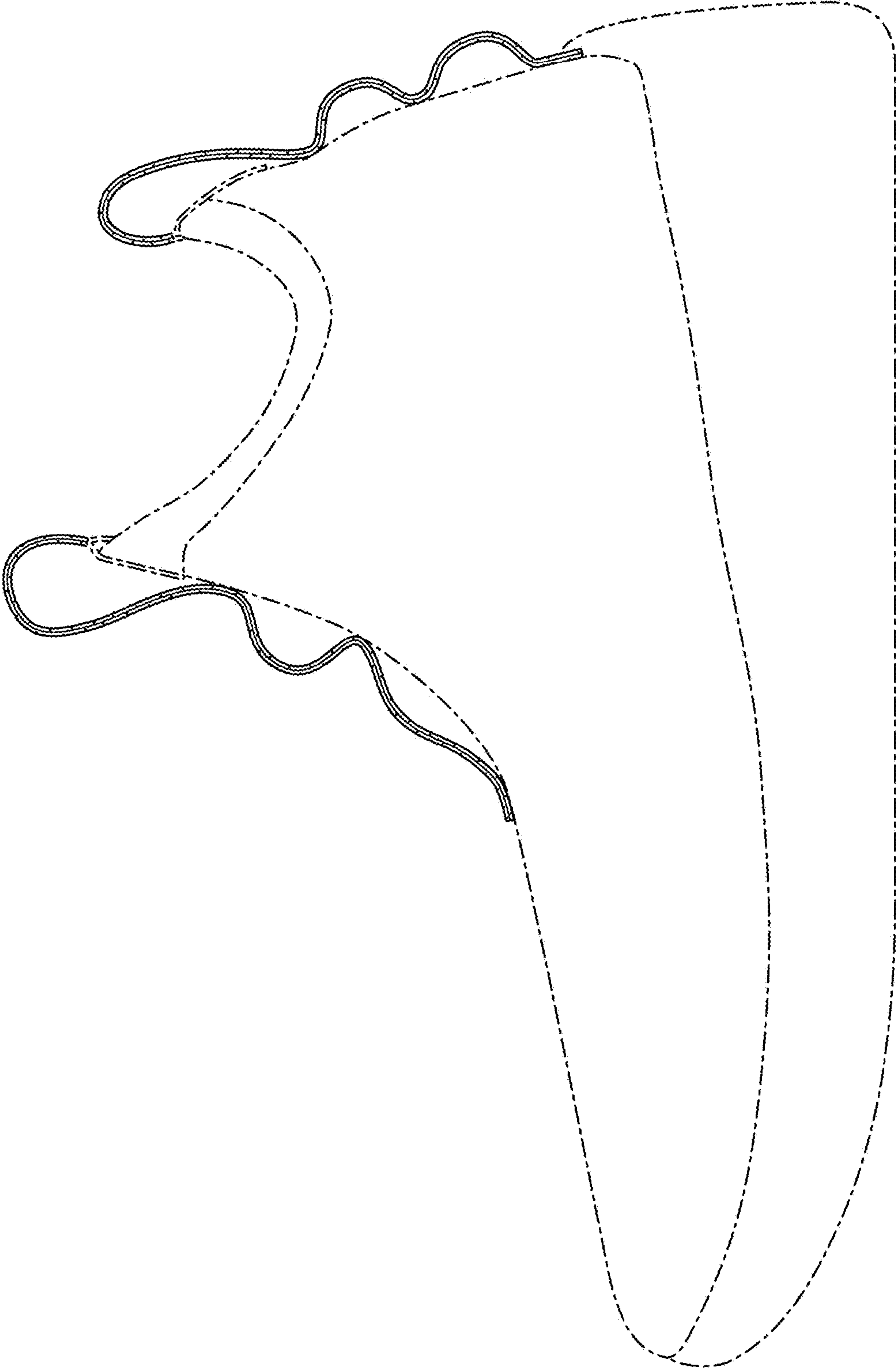

FIG. 3

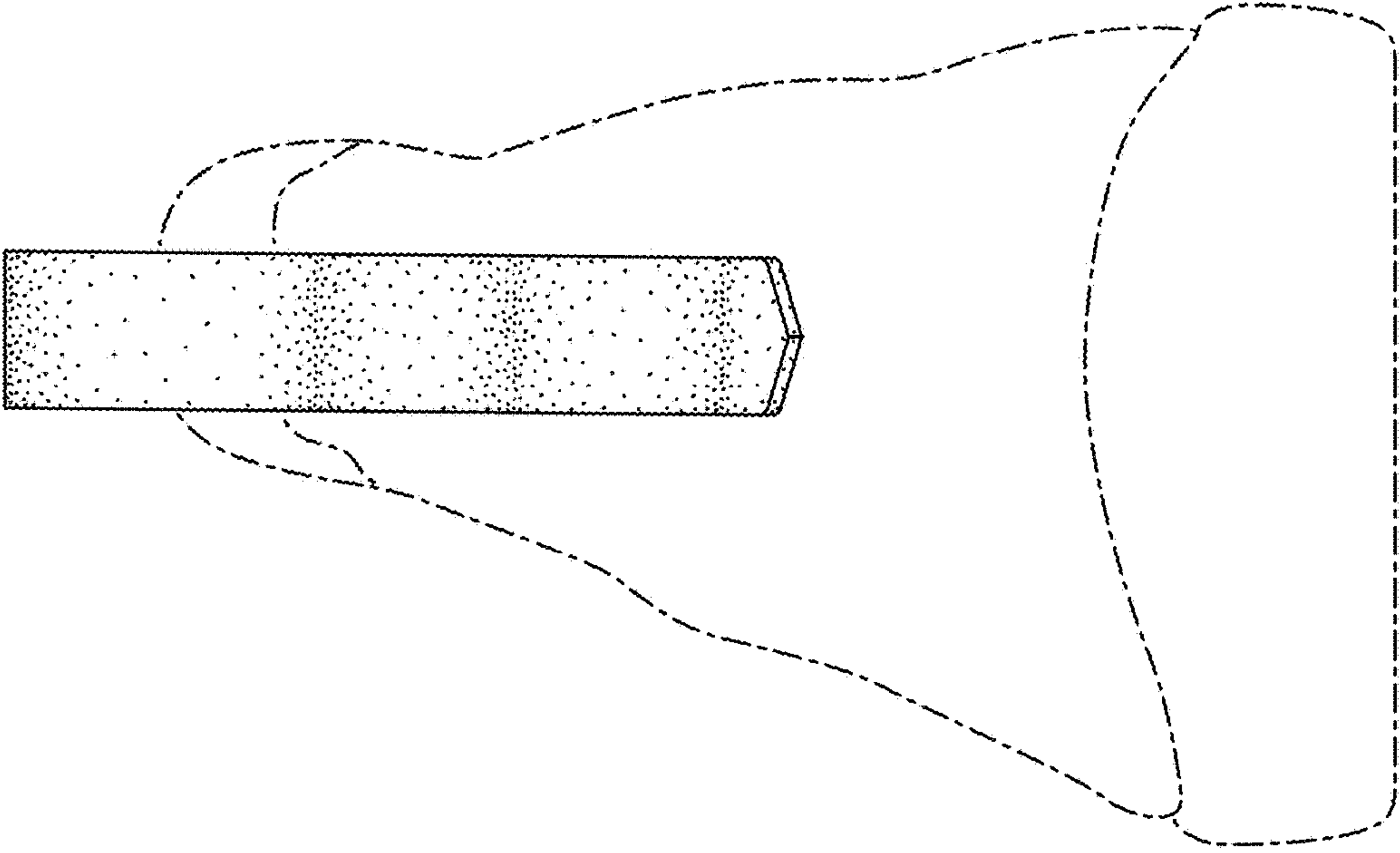

FIG. 4

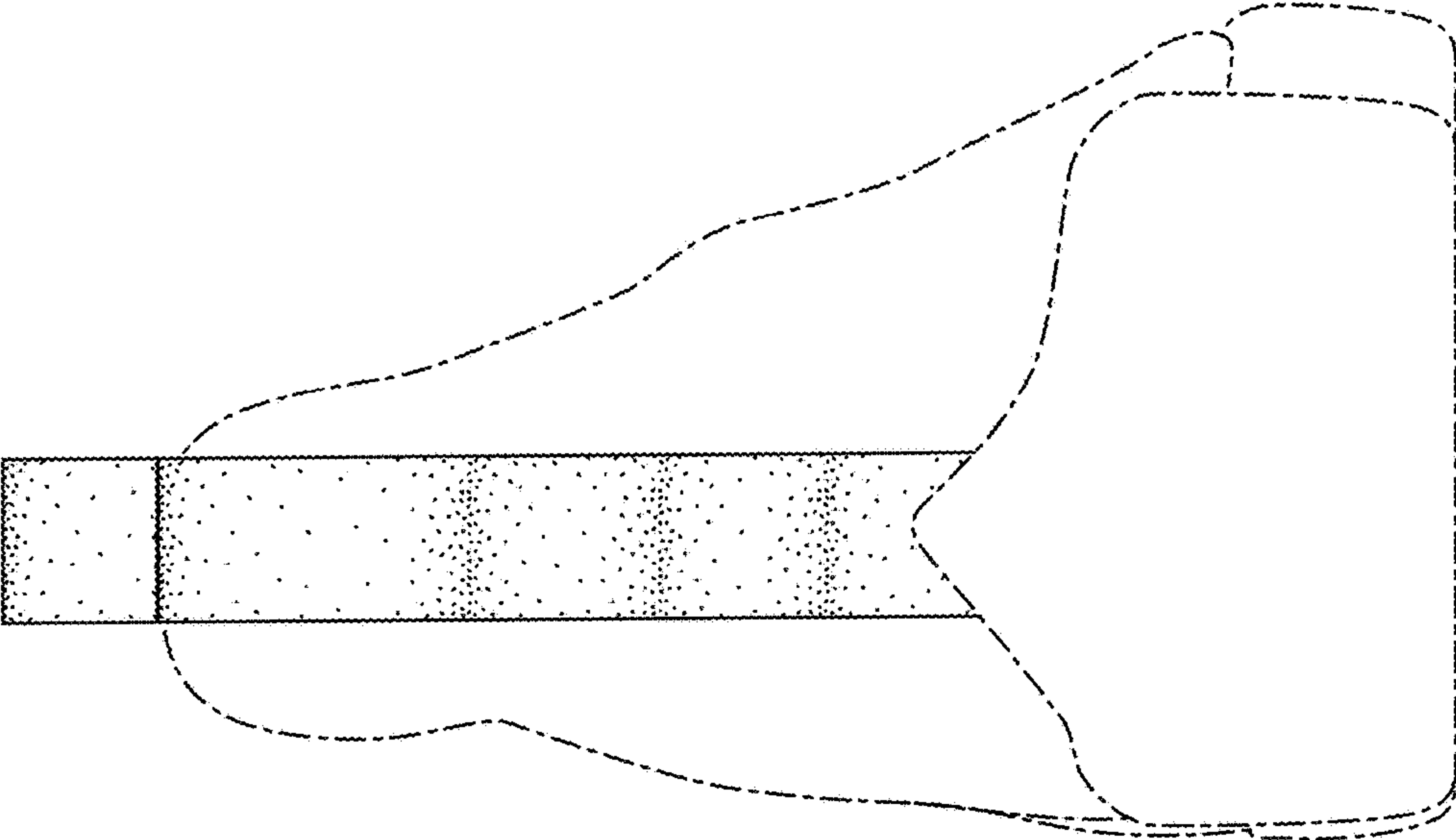

FIG. 5

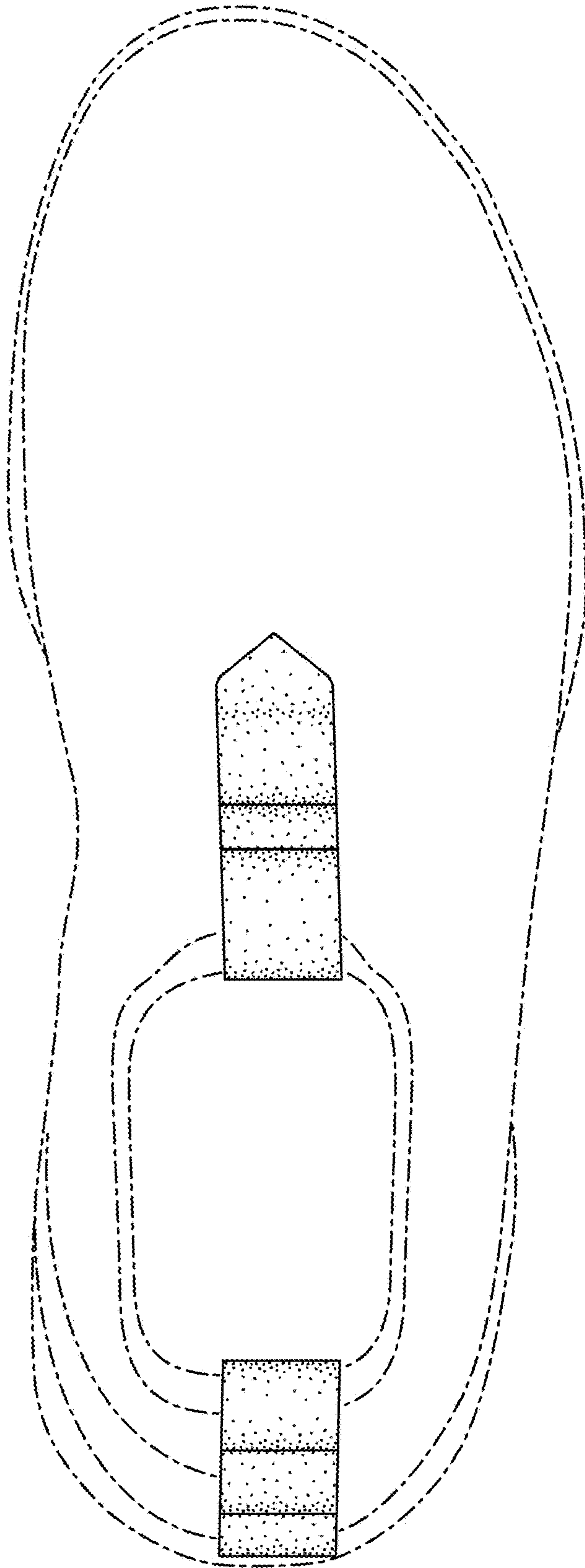

FIG. 6