



US00D826469S

(12) **United States Design Patent** (10) **Patent No.:** **US D826,469 S**
Reynolds (45) **Date of Patent:** **** Aug. 21, 2018**

(54) **HORTICULTURE GROW LIGHT**

(71) Applicant: **IP Holdings, LLC**, Vancouver, WA (US)
(72) Inventor: **Christopher Reynolds**, Vancouver, WA (US)
(73) Assignee: **HGCI, Inc.**, Las Vegas, NV (US)
(**) Term: **15 Years**

(21) Appl. No.: **29/621,531**
(22) Filed: **Oct. 9, 2017**

Related U.S. Application Data

(63) Continuation of application No. 29/593,778, filed on Feb. 13, 2017, now Pat. No. Des. 802,829, which is (Continued)

(51) **LOC (11) Cl.** **29-99**
(52) **U.S. Cl.**
USPC **D26/118**

(58) **Field of Classification Search**
USPC ... D26/9, 10, 12, 13, 15, 16, 24, 51, 61, 72, D26/76, 80, 81, 85, 86, 88, 90, 113, 118, (Continued)

(56) **References Cited**

U.S. PATENT DOCUMENTS

32,722 A 7/1861 Schmidlin
D46,253 S 8/1914 Kopp
(Continued)

FOREIGN PATENT DOCUMENTS

CA 2034710 8/1991
CA 1314529 3/1993
(Continued)

OTHER PUBLICATIONS

Apollo Horticulture GLRCTAC 6" Air Cool Tube Grow Light Deluxe Glass Cylinder with Hood Reflector, image post date Oct. 15, 2010, site visted Oct. 3, 2014, (online), <http://www.amazon.com/apollo-horticulture-glrectac-cylinder-reflector/dp/b003qkvv04/ref=pd_sbs_19_5?ie=utf8&refrid=1y9v9qhh4n5vntjmftr>.

(Continued)

Primary Examiner — Brian N. Vinson

(74) *Attorney, Agent, or Firm* — J. Douglas Wells

(57) **CLAIM**

The ornamental design for a horticulture grow light, as shown and described.

DESCRIPTION

FIG. 1 is a perspective view of a horticulture grow light, as viewed from below, showing my new design;
FIG. 2 is a perspective view of the light shown in FIG. 1, as viewed from above;
FIG. 3 is a left side view of the light shown in FIG. 1;
FIG. 4 is a right side view of the light shown in FIG. 1;
FIG. 5 is a front elevation view of the light shown in FIG. 1;
FIG. 6 is a rear elevation view of the light shown in FIG. 1;
FIG. 7 is a bottom plan view of the light shown in FIG. 1; and,
FIG. 8 is a top plan view of the light shown in FIG. 1.
The broken line disclosure shown in the views is understood to represent portions of the article in which the claimed design is embodied, but which form no part of the claimed design. Where a broken line borders a claimed surface, that broken line is understood to represent an unclaimed boundary between the claimed and unclaimed surfaces.

1 Claim, 6 Drawing Sheets

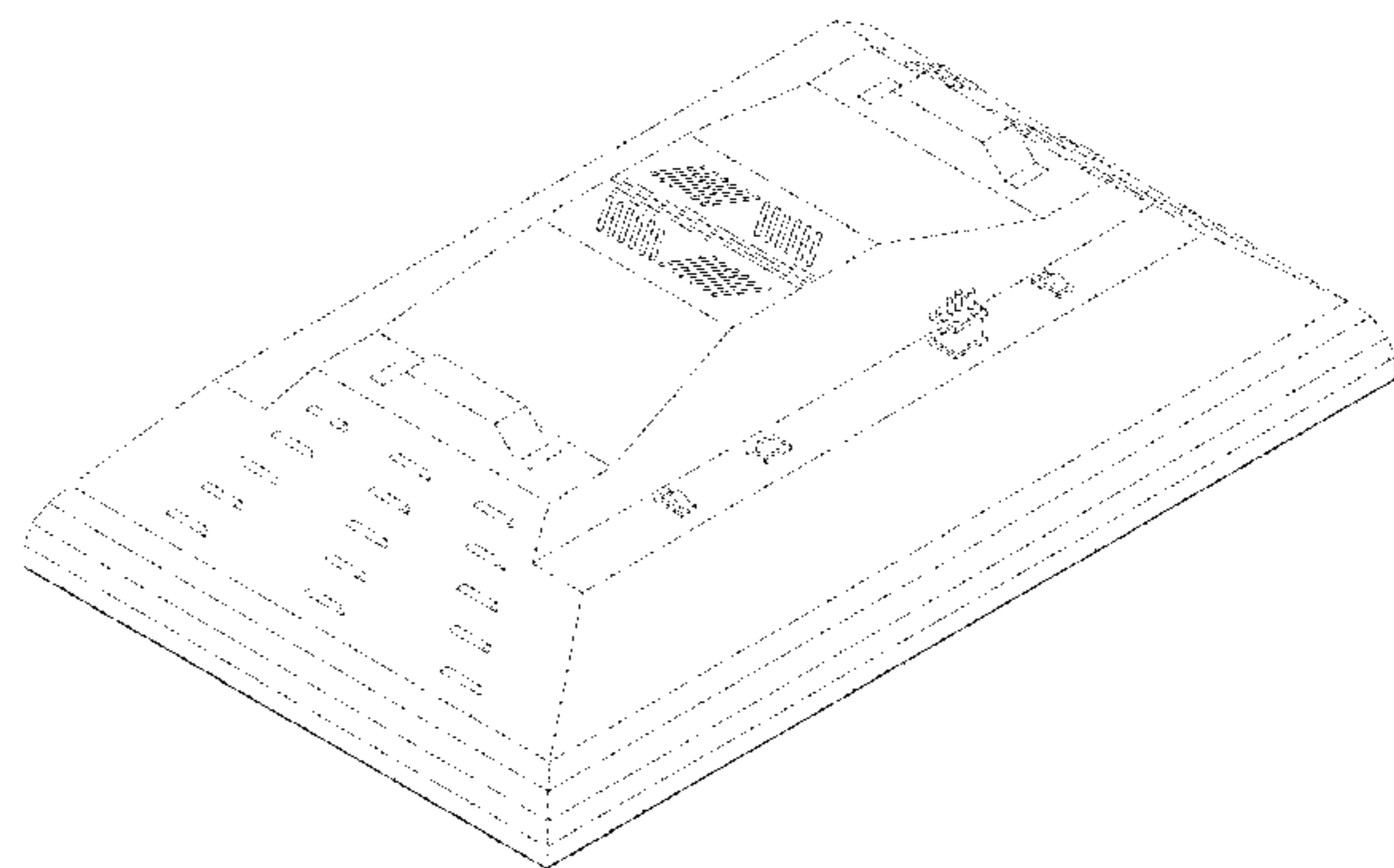
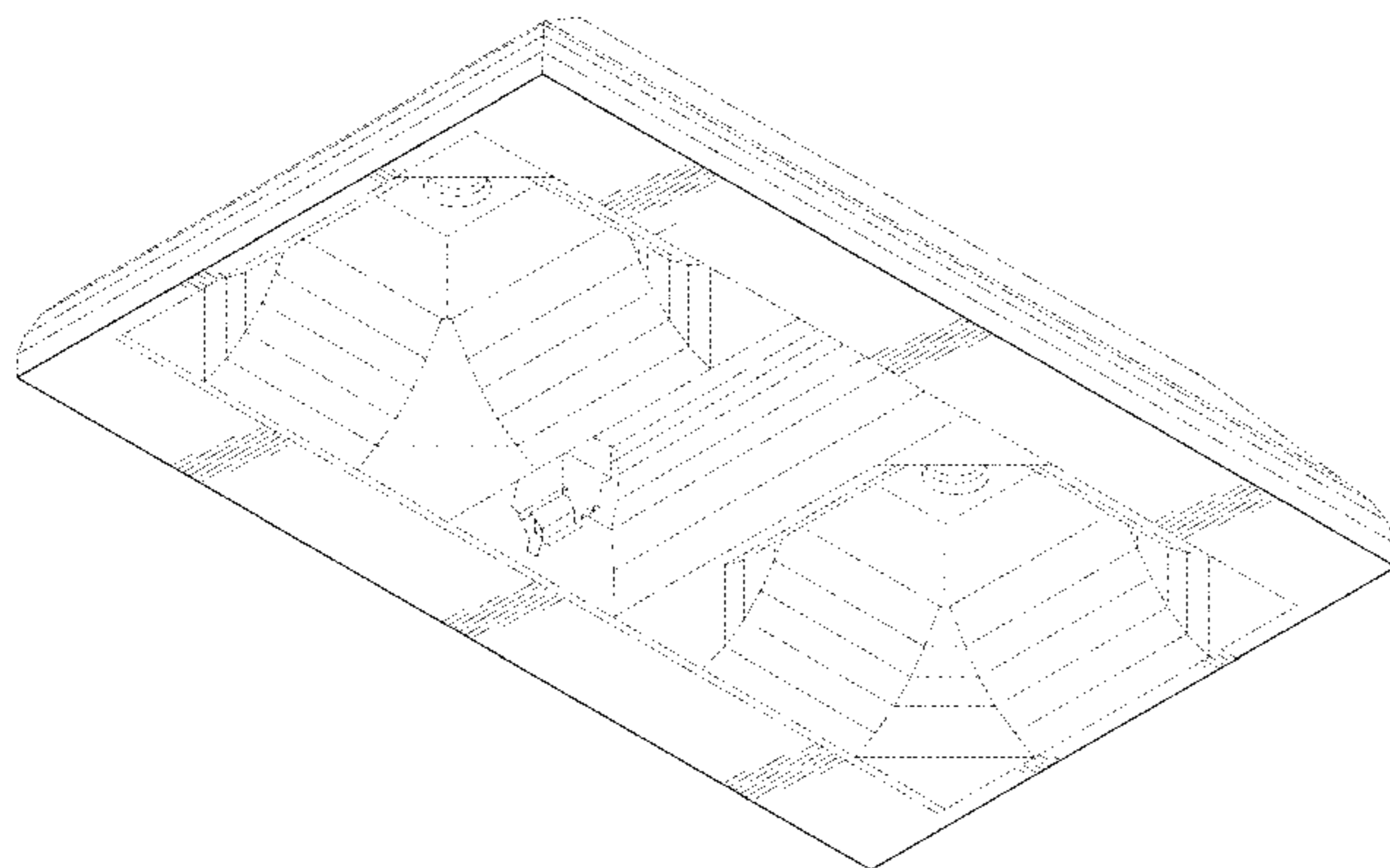

Related U.S. Application Data

a continuation of application No. 29/572,282, filed on Jul. 26, 2016, now Pat. No. Des. 781,492, which is a continuation of application No. 29/531,242, filed on Jun. 24, 2015, now Pat. No. Des. 770,670.

(58) **Field of Classification Search**

USPC D26/119, 120, 122, 128, 129, 138, 143, D26/144
 CPC B60Q 1/04; B60Q 1/26; F21S 8/026; F21S 8/04; F21L 19/00; F23D 11/443; F21Y 2101/02; F21V 21/02; F21V 29/004; F21V 21/04; F21V 29/2212; F21V 7/22; F21V 29/83; F21V 37/002; F21V 7/00; A61L 9/037

See application file for complete search history.

(56) **References Cited**

U.S. PATENT DOCUMENTS

1,410,945 A 3/1922 Mayfield
 1,547,026 A 7/1925 Canney
 1,798,567 A 3/1931 Wagenhorst
 D85,049 S 9/1931 Kopp
 D85,382 S 10/1931 Guth
 1,848,734 A 3/1932 Luce
 1,873,310 A 8/1932 Doane
 1,930,070 A 10/1933 Zecher
 1,987,705 A 1/1935 Pedersen
 D106,614 S 10/1937 Waterbury
 2,194,841 A 3/1940 Welch
 D119,800 S 4/1940 Carter
 D123,768 S 12/1940 Scribner
 D125,559 S 3/1941 Biller
 2,242,590 A 5/1941 Marcel
 D128,049 S 7/1941 Kurtz
 D135,375 S 3/1943 Biller
 2,339,100 A 1/1944 Netting
 2,348,617 A 5/1944 Furedy
 D156,014 S 11/1949 Lazerson
 2,492,946 A 1/1950 Barber
 D174,221 S 3/1955 Hatch
 2,740,883 A 4/1956 Kruger
 2,741,694 A 4/1956 Wiig
 2,998,511 A 8/1961 Kingsley Chan
 3,025,391 A 3/1962 Golko
 D193,802 S 10/1962 Thomsen
 D195,012 S 4/1963 Hoyle
 3,125,301 A 3/1964 Stotter
 3,263,071 A 7/1966 Fabbri
 3,272,978 A 9/1966 Jackson
 3,322,946 A 5/1967 Cooper
 3,420,995 A 1/1969 Dunkel
 D213,391 S 2/1969 Bruno
 3,433,941 A 3/1969 Hall
 3,675,008 A 7/1972 Hill
 3,684,883 A 8/1972 Entwistle
 3,701,898 A 10/1972 McNamara, Jr.
 3,755,667 A 8/1973 Price
 3,829,677 A 8/1974 DeLlano
 3,902,059 A 8/1975 McNamara, Jr.
 3,911,265 A 10/1975 Landrum
 4,028,542 A 6/1977 McReynolds, Jr.
 D245,016 S 7/1977 Barr
 4,037,096 A 7/1977 Brengord
 4,078,169 A 3/1978 Armstrong
 4,175,360 A 11/1979 Mulvey
 4,229,782 A 10/1980 Ruud
 D259,738 S 6/1981 Boschetti
 4,308,473 A 12/1981 McNamara, Jr.
 D262,659 S 1/1982 Lalita
 D266,578 S 10/1982 Moshier
 D268,287 S 3/1983 Boschetti
 D270,577 S 9/1983 DeVos
 4,446,506 A 5/1984 Larson

4,531,180 A 7/1985 Hernandez
 4,616,293 A 10/1986 Baliozian
 4,669,033 A 5/1987 Lee
 D290,662 S 7/1987 Basil
 D300,877 S 4/1989 Cyr
 4,855,884 A 8/1989 Richardson
 4,893,221 A 1/1990 Friedman
 4,933,821 A 6/1990 Anderson
 4,939,629 A 7/1990 Glanton
 D311,597 S 10/1990 Poot
 4,970,428 A 11/1990 Hayakawa
 4,980,809 A 12/1990 Baldwin
 D316,301 S 4/1991 Michael
 5,006,752 A 4/1991 Eggink
 5,065,294 A 11/1991 Poot
 5,072,349 A 12/1991 Waniga
 D323,897 S 2/1992 Compton
 5,088,015 A 2/1992 Baggio
 D329,104 S 9/1992 Dieperink
 D330,438 S 10/1992 Herst
 5,192,129 A 3/1993 Figueroa
 5,199,784 A 4/1993 Hempleman
 5,253,152 A 10/1993 Yang
 D349,358 S 4/1994 Herst
 5,353,746 A 10/1994 Del Rosario
 D352,126 S 11/1994 Ruud
 5,440,470 A 8/1995 Ly
 5,461,554 A 10/1995 Leonetti
 D365,159 S 12/1995 Tinen
 5,486,737 A 1/1996 Hrubowchak
 5,510,676 A 4/1996 Cottaar
 D373,000 S 8/1996 Brady
 5,555,162 A 9/1996 Shemitz
 D374,301 S 10/1996 Kleffiman
 D376,437 S 10/1996 Karlo
 5,568,680 A 10/1996 Parker
 5,570,947 A 11/1996 Felland
 D377,993 S 2/1997 Herst
 5,621,267 A 4/1997 Shaffner
 D383,243 S 9/1997 Fry
 5,698,947 A 12/1997 Choi
 5,702,179 A 12/1997 Sidwell
 D391,632 S 3/1998 Thomas
 D396,319 S 7/1998 Sutton
 D397,481 S 8/1998 Schafer
 D399,328 S 10/1998 Compton
 D399,329 S 10/1998 Compton
 D399,587 S 10/1998 Compton
 D400,289 S 10/1998 Wardenburg
 5,816,694 A 10/1998 Ideker
 D401,006 S 11/1998 Edwards
 D405,976 S 2/1999 Beall
 5,896,004 A 4/1999 Feldman
 5,924,789 A 7/1999 Thornton
 5,932,955 A 8/1999 Berger
 5,938,317 A 8/1999 Thornton
 D415,304 S 10/1999 Brown
 5,983,564 A 11/1999 Stragnola
 5,987,697 A 11/1999 Song
 5,999,943 A 12/1999 Nori
 D418,626 S 1/2000 Herst
 D419,248 S 1/2000 Lyons
 6,024,468 A 2/2000 Kassay
 6,042,250 A 3/2000 Stragnola
 6,051,927 A 4/2000 Graser
 6,053,624 A 4/2000 Cronk
 D425,237 S 5/2000 Scott
 D425,652 S 5/2000 Brok
 D426,010 S 5/2000 Compton
 6,061,690 A 5/2000 Nori
 6,065,849 A 5/2000 Chen
 6,070,173 A 5/2000 Huber
 6,076,944 A 6/2000 Maranon
 6,079,851 A 6/2000 Altman
 D428,516 S * 7/2000 Reo D26/118
 6,094,919 A 8/2000 Bhatia
 6,111,739 A 8/2000 Wu
 6,152,579 A 11/2000 Reed
 D439,008 S 3/2001 Kim

(56)

References Cited

U.S. PATENT DOCUMENTS

D440,289 S	4/2001	Olson et al.	7,445,363 B2	11/2008	Vanden Eynden
6,210,025 B1	4/2001	Schmidt	7,524,090 B2	4/2009	Hargreaves
6,230,497 B1	5/2001	Morris	7,534,011 B2	5/2009	Townsley
D443,198 S	6/2001	Snyder	D595,894 S	7/2009	Verfuert
D443,949 S	6/2001	Dimonte	D602,625 S	10/2009	Santoro
6,247,830 B1	6/2001	Winnett	D603,087 S	10/2009	Mo
D445,943 S	7/2001	Littman	7,617,057 B2	11/2009	May
6,257,735 B1	7/2001	Baar	D605,342 S	12/2009	Chung
6,267,483 B1	7/2001	Hembery	D608,490 S	1/2010	Chung
D447,272 S *	8/2001	Smith D26/118	7,641,367 B2	1/2010	Hargreaves
6,279,012 B1	8/2001	Sexton	7,654,702 B1	2/2010	Ding
6,299,327 B1	10/2001	Camarota	D611,183 S	3/2010	Duarte
D452,559 S	12/2001	Schonberger	D613,900 S	4/2010	Hargreaves
6,343,984 B1	2/2002	Langdon	D614,801 S *	4/2010	Collins D26/118
6,371,630 B1	4/2002	Unger	7,722,228 B2	5/2010	Broer
D456,927 S	5/2002	Russello	D617,028 S	6/2010	Verfuert
D456,928 S	5/2002	Russello	D620,190 S	7/2010	Chung
D456,938 S *	5/2002	Wardenburg D26/118	D621,993 S	8/2010	Jong
D457,450 S	5/2002	Lamond et al.	7,771,086 B2	8/2010	Goverde
D459,825 S	7/2002	Field	D628,335 S	11/2010	Hyland
6,488,387 B2	12/2002	Wardenburg	7,854,534 B2	12/2010	Liu
D469,564 S	1/2003	Brok	D632,419 S	2/2011	Ng
6,527,422 B1	3/2003	Hutchison	D633,247 S	2/2011	Kong
6,548,948 B1	4/2003	Muessli	D633,640 S	3/2011	Wauters
6,595,662 B2	7/2003	Wardenburg	D634,060 S *	3/2011	Wardenburg D26/118
6,601,972 B2	8/2003	Sei	D634,240 S	3/2011	Junkeer
6,658,652 B1	12/2003	Alexander	D634,468 S	3/2011	Hargreaves
6,679,619 B2	1/2004	Saieva	D634,469 S *	3/2011	Hargreaves D26/118
D486,593 S	2/2004	Griffin	D637,162 S	5/2011	Bridgman
6,688,759 B1	2/2004	Hadjimichael	D637,341 S	5/2011	Wardenburg
6,709,131 B1	3/2004	Herst	D637,752 S	5/2011	Mekhtarian
6,729,383 B1	5/2004	Cannell	D640,404 S	6/2011	Chipperfield
6,783,263 B1	8/2004	Cronk	7,959,331 B2	6/2011	Ho
D496,121 S	9/2004	Santoro	D641,100 S	7/2011	Li
D499,504 S	12/2004	Meyer	7,972,044 B2	7/2011	Burkhauser
D499,505 S	12/2004	Benensohn	D644,185 S	8/2011	Hargreaves
D504,343 S	4/2005	Ek	7,987,632 B2	8/2011	May
6,885,134 B2	4/2005	Kurashima	8,018,630 B2	9/2011	Herloski
6,908,212 B2	6/2005	Schultz	8,038,318 B2	10/2011	Plunk
7,011,424 B1	3/2006	Poulson	D648,652 S	11/2011	Hawkins
7,083,309 B2	8/2006	Chan	D649,685 S	11/2011	Trzesniowski
7,101,060 B2	9/2006	Oppenheimer	D650,515 S	12/2011	Bradley
7,131,753 B1	11/2006	Edwards, Jr.	D650,935 S	12/2011	Beghelli
7,156,539 B2	1/2007	Cronk	D653,376 S	1/2012	Kong
7,175,309 B2	2/2007	Craw	8,113,696 B2	2/2012	Striebel
D542,460 S	5/2007	Hargreaves	D655,403 S	3/2012	Zakula
D543,652 S *	5/2007	Hargreaves D26/118	D657,748 S	4/2012	Hargreaves
D543,654 S	5/2007	Hargreaves	D660,252 S	5/2012	Hargreaves
D543,655 S	5/2007	Hargreaves	D661,370 S	6/2012	Imajo
D544,982 S	5/2007	Hargreaves	D661,833 S	6/2012	Imajo
7,213,948 B2	5/2007	Hein	8,209,912 B2	7/2012	Hargreaves
D544,136 S	6/2007	Hargreaves	8,215,799 B2	7/2012	Vanden Eynden
D544,138 S	6/2007	Hargreaves	D667,584 S	9/2012	Beghelli
D544,139 S	6/2007	Hargreaves	D668,370 S	10/2012	Guercio
D544,626 S	6/2007	Hargreaves	D671,259 S	11/2012	Chen
D544,980 S	6/2007	Hargreaves	D672,908 S	12/2012	Wilcox
D544,981 S	6/2007	Hargreaves	D672,911 S	12/2012	Mayfield, III
D544,983 S	6/2007	Hargreaves	D673,324 S	12/2012	Mayfield
D544,984 S	6/2007	Hargreaves	8,334,640 B2	12/2012	Reed
D544,985 S	6/2007	Hargreaves	D675,369 S *	1/2013	Michaud D26/118
D544,987 S	6/2007	Hargreaves	8,348,481 B2	1/2013	Chang
D544,994 S	6/2007	Hargreaves	D675,772 S	2/2013	Tran
D544,995 S *	6/2007	Hargreaves D26/118	8,371,726 B2	2/2013	Collins
D545,460 S	6/2007	Mason, II	D678,597 S	3/2013	Lehman
D545,484 S *	6/2007	Hargreaves D26/118	D678,599 S	3/2013	Boyer
D545,485 S *	6/2007	Hargreaves D26/118	D679,848 S	4/2013	Pickard
D545,990 S	7/2007	Hargreaves	D683,064 S	5/2013	Tuck
D545,994 S	7/2007	Hargreaves	8,505,224 B2	8/2013	Huang
D545,996 S	7/2007	Hargreaves	D689,238 S	9/2013	Halsey
D549,869 S	8/2007	Ward	D689,986 S	9/2013	Lord
D553,781 S	10/2007	Pickard	D690,875 S	10/2013	McKenzie
7,296,914 B1	11/2007	Russello	D693,959 S *	11/2013	Boyer D26/118
7,360,927 B2	4/2008	Oka	D697,663 S	1/2014	Speier
D569,024 S	5/2008	Redfern	D698,074 S	1/2014	Hargreaves
D572,858 S	7/2008	Santoro	D698,075 S	1/2014	Klus
			D698,986 S *	2/2014	Reynolds D26/118
			D698,987 S	2/2014	Stanley
			D699,386 S	2/2014	Park
			D702,827 S	4/2014	Mase

(56)

References Cited

U.S. PATENT DOCUMENTS

8,702,283	B2	4/2014	Bradley, Jr.	9,310,037	B2	4/2016	Cercone
D705,474	S	5/2014	Philips	D756,016	S	5/2016	Hargreaves
D705,974	S	5/2014	Blessitt	D756,023	S	5/2016	Hoffer
8,723,086	B2	5/2014	McMahan	D756,026	S	5/2016	Reynolds
D707,385	S	6/2014	Wardenburg	D757,323	S	5/2016	Reynolds
D708,390	S	7/2014	Roos	D757,326	S	5/2016	Reynolds
D710,528	S	8/2014	Wardenburg	D757,346	S	5/2016	Stanley
8,801,235	B2	8/2014	Yurich	9,335,038	B2	5/2016	Stanley
D713,953	S	9/2014	Jepson	9,366,947	B2	6/2016	Miyata
D714,988	S	10/2014	Park	D762,320	S	7/2016	Reynolds
D715,994	S	10/2014	Klus	D765,306	S	8/2016	Wardenburg
D716,995	S	11/2014	Zhu	D766,756	S	9/2016	Franc
D717,487	S	11/2014	Guzzini	9,451,743	B2	9/2016	Koemer
D717,636	S	11/2014	Stanley	D769,513	S	10/2016	Reynolds
D720,488	S	12/2014	Toyohisa	D769,514	S	10/2016	Reynolds
D720,505	S	12/2014	Kersten	D770,079	S	10/2016	Stanley
8,905,575	B2 *	12/2014	Durkee F21V 7/0008 362/218	D770,082	S	10/2016	Reynolds
D720,876	S	1/2015	Haverfield	D770,670	S	11/2016	Reynolds
D721,844	S	1/2015	Lay	D770,671	S	11/2016	Reynolds
D722,654	S	2/2015	Martone	D771,301	S	11/2016	Stanley
D725,820	S	3/2015	Hargreaves	D771,304	S	11/2016	Goltche
8,967,821	B2	3/2015	Pickard	D773,107	S	11/2016	Stanley
D726,359	S	4/2015	Grigore	D774,234	S	12/2016	Plourde
8,998,473	B1	4/2015	Anderson	D775,406	S	12/2016	Hargreaves
9,016,892	B1	4/2015	Scribante	D775,760	S	1/2017	Reynolds
9,016,907	B2	4/2015	Stanley	9,551,482	B2	1/2017	Seward
D728,848	S	5/2015	Reyes	D780,985	S	3/2017	Stanley
D729,435	S	5/2015	Arndt	D780,986	S	3/2017	Reynolds
D730,556	S	5/2015	Toyohisa	D781,492	S	3/2017	Reynolds
D725,819	S	6/2015	Reynolds	D783,887	S	4/2017	Stanley
D731,103	S	6/2015	Wilke	D783,888	S	4/2017	Reynolds
D731,109	S	6/2015	Wardenburg	D786,477	S	5/2017	Lauderdale
D731,701	S *	6/2015	Hargreaves D26/118	D786,488	S	5/2017	Reynolds
D732,233	S	6/2015	Reynolds	D786,489	S	5/2017	Stanley
D732,234	S	6/2015	Rashidi Doust	D786,490	S	5/2017	Stanley
D732,235	S *	6/2015	Reynolds D26/118	D786,491	S	5/2017	Reynolds
D732,236	S *	6/2015	Reynolds D26/118	D792,635	S	7/2017	Reynolds
D733,347	S	6/2015	Dungan	D793,616	S	8/2017	Reynolds
9,052,075	B2	6/2015	Demuynck	D796,727	S	9/2017	Reynolds
D733,952	S	7/2015	Lay	D796,728	S	9/2017	Reynolds
D733,960	S	7/2015	Howe	D797,350	S	9/2017	Reynolds
D734,534	S	7/2015	Howe	D797,353	S	9/2017	Stanley
D735,391	S	7/2015	Blessitt	9,750,199	B2	9/2017	Stanley
D735,401	S	7/2015	Clements	9,752,766	B2	9/2017	Stanley
D736,450	S *	8/2015	Reynolds D26/118	D802,826	S	11/2017	Stanley
D737,498	S	8/2015	Stanley	D802,828	S	11/2017	Stanley
9,110,209	B2	8/2015	Blessitt	D802,829	S	11/2017	Stanley
D738,031	S	9/2015	Martins	D802,830	S	11/2017	Stanley
D739,595	S	9/2015	Reynolds	2002/0073285	A1	6/2002	Butterworth
9,127,826	B2	9/2015	Boyer	2002/0141195	A1	10/2002	Wardenburg
D740,486	S *	10/2015	Stanley D26/118	2003/0031011	A1	2/2003	Miller
D740,996	S	10/2015	Tragatschnig	2003/0191783	A1	10/2003	Wolczko
D745,993	S	12/2015	Reynolds	2004/0240214	A1	12/2004	Whitlow
D747,029	S *	1/2016	Reynolds D26/118	2005/0117333	A1	6/2005	Yoshida
D747,538	S	1/2016	Reynolds	2005/0160481	A1	7/2005	Todd
D747,825	S	1/2016	Reynolds	2005/0233691	A1	10/2005	Horton
D747,849	S	1/2016	Reynolds	2006/0231081	A1	10/2006	Kirakosyan
D747,923	S	1/2016	Cornu	2006/0232984	A1	10/2006	Schuknecht
D748,319	S	1/2016	Johnson	2006/0282457	A1	12/2006	Williams
D748,320	S	1/2016	Johnson	2007/0051321	A1	3/2007	Chang
D748,847	S	1/2016	Johnson	2007/0070633	A1	3/2007	Eynden
D748,850	S	1/2016	Johnson	2007/0228993	A1	10/2007	Stuer
D748,849	S *	2/2016	Stanley D26/118	2007/0246631	A1	10/2007	Brown
D749,773	S	2/2016	Waible	2007/0282806	A1	12/2007	Hoffman
D750,312	S	2/2016	Reynolds	2008/0059799	A1	3/2008	Scarlata
D750,313	S	2/2016	Reynolds	2008/0117617	A1	5/2008	Hargreaves
D750,316	S *	2/2016	Reynolds D26/118	2008/0130304	A1	6/2008	Rash
9,255,690	B2	2/2016	Dimitriadis	2008/0205030	A1	8/2008	Hargreaves
D750,831	S	3/2016	Clements	2008/0205071	A1	8/2008	Townsley
D751,244	S *	3/2016	Reynolds D26/118	2008/0212326	A1	9/2008	Chon
D751,245	S	3/2016	Stanley	2008/0178957	A1	11/2008	Pickard
D751,247	S *	3/2016	Reynolds D26/118	2008/0278950	A1	11/2008	Pickard
9,279,553	B1	3/2016	Scribante	2009/0166250	A1	5/2009	Hargreaves
D753,654	S	4/2016	Eastwood	2009/0231840	A1	9/2009	Boehme
				2009/0262540	A1	10/2009	Hargreaves
				2009/0276478	A1	11/2009	Soman
				2009/0310373	A1	12/2009	Burkhauser
				2009/0316404	A1	12/2009	Mo
				2009/0323335	A1	12/2009	Yang

(56)

References Cited

U.S. PATENT DOCUMENTS

2010/0214789	A1	8/2010	Hawkes
2010/0238661	A1	9/2010	Pfund
2010/0277908	A1	11/2010	Hu
2010/0277929	A1	11/2010	Hargreaves
2010/0295468	A1	11/2010	Pedersen
2010/0302768	A1	12/2010	Collins
2011/0169412	A1	7/2011	Yurich
2011/0203096	A1	8/2011	Hargreaves
2011/0259665	A1	10/2011	Morgan
2012/0051041	A1	3/2012	Edmond
2012/0092859	A1	4/2012	Gregoris
2012/0145699	A1	6/2012	McMahan
2012/0212883	A1	8/2012	Hargreaves
2012/0230035	A1	9/2012	Bradley, Jr.
2012/0302768	A1	11/2012	Collins
2013/0083539	A1	1/2013	Dimitriadis
2013/0077329	A1	3/2013	Hessling
2013/0155685	A1	6/2013	Stanley
2013/0242573	A1	9/2013	Petrsocki
2013/0250567	A1	9/2013	Edmond
2014/0378283	A1	12/2014	Qiu
2015/0023022	A1	1/2015	Stanley
2015/0098215	A1	4/2015	Torabifard
2015/0252992	A1	9/2015	Stanley
2015/0252993	A1	9/2015	Stanley
2015/0252994	A1	9/2015	Stanley
2015/0260381	A1	9/2015	Verfuert
2017/0211801	A1	7/2017	Stanley

FOREIGN PATENT DOCUMENTS

EP	0325003	7/1989
EP	0440274	8/1991
WO	2002063210	8/2002
WO	2003060379	7/2003
WO	2008018000	2/2008
WO	2009096775	8/2009
WO	2011119451	9/2011

OTHER PUBLICATIONS

Apollo Horticulture GLRLS24 6" Air Cooled Hydroponic Grow Light Glass Reflector Hood, image post date Oct. 15, 2010, site visited Oct. 3, 2014, (online), <http://www.amazon.com/apollo-horticulture-GLRLS24-hydroponic-reflector/dp/B00BMVK8HG/ref=cm_cd_qh_dp_i>.

Adjustable Reflector, image post date Apr. 23, 2012, site visited Sep. 23, 2015, http://web.archive.org/web/2012043260757/http://hydroponics-products.en.alibaba.com/product/519225678-213056444/adjustable_reflector_grow_light_hydroponics_greenhouse_horticulture_reflector_hood.html.

Agrotech Magnum Reflector, image post date Feb. 5, 2012, site visited Oct. 31, 2014, www.hydroponics.net/136580.

Cree CR22, image post date Apr. 28, 2011, site visited Nov. 15, 2014, <http://ledsmagazine.com/content/dam/leds/migrated/objects/news/8/4/19/cree204272011.jpg>.

ZR series High Efficacy Troffer, image post date Apr. 13, 2012, site visited Oct. 31, 2014, www.cree.com/lighting/products.

Grow Lights Home Depot: Find many types of grow lights for your plant, published Dec. 22, 2012, online. Site visited Jun. 25, 2014. [Http://besthomedecorfurniture.com/gardening-decor/grow-lights-home-depot-few-things-to-consider-when-buying-grow-lighting-plants-online.html](http://besthomedecorfurniture.com/gardening-decor/grow-lights-home-depot-few-things-to-consider-when-buying-grow-lighting-plants-online.html).

LED Grow Light Comparison Test Review, Youtube.com, published Jun. 29, 2012, online. Site visited Jun. 25, 2014. www.youtube.com/watch?v=f-8oy0qbgrs.

Illuminator Pro-Series Hybrid 350W, wordpress.com, published Dec. 22, 2010, online, site visited Jun. 25, 2014. <http://growsetup.wordpress.com/category/grow-lights/>.

California Lightworks New SolarStorm 440W LED Grow Light with UVB, hydrobuilder.com, online. Site visited May 25, 2014.

http://hydrobuilder.com/solarstorm-440w-led-grow-light-with-uvb.html?dzid=strands_CLW-SS-440.

2013 Sunlight Supply Catalog, Issuu.com, published Aug. 1, 2013, online. Site visited Feb. 2, 2015. http://issuu.com/sunlightsupply/docs/2013_sunlightproductcatalog/49.

Pages 29 and 54 from 2014-2015 dealer catalog showing and describing Super Sun DE reflector published by Sunlight Supply, Inc. 2014.

Dominator XXXL Non AC Reflector pack of 3 Spec Sheet, GreenTreesHydroponics.com, date available Mar. 12, 2014, online. Site visited Feb. 3, 2015, <https://www.hydroponics.net/i/141477>.

Low Rider Air-Cooled Reflector—TinEye, image post date Oct. 11, 2012, site visited Oct. 1, 2015, www.tineye.com/search/1b0e187c5ed9e4e9cfb55d0472271385a2c0e88/?pluginver.

OG Air Cooled Parabolic Reflector Only—Make the Most of Your Grow Light, GroWell Hydroponics, <http://www.growell.co.uk/og-air-cooled-parabolic-reflector-only.html>, pp. 1-2, accessed Aug. 26, 2014.

Air Resistance: Distinguishing Between Laminar and Turbulent Flow, www.docstoc.com, Dec. 29, 2010, p. 1-6.

Sun Systems LEC 630 Light Emitting Ceramic Fixture, Spec Sheet for 906217—Sun System LEC 630 120 Volt w/ 3100 K Lamps, www.sunlightsupply.com/shop/bycategory/led-lighting/sun-system-lec-630-light-emitting-ceramic-fixture, online, updated Feb. 9, 2015. Site visited Mar. 30, 2015, p. 1.

Mohri, Mineko, International Preliminary Report on Patentability for PCT/US2014/014959, Jan. 19, 2016.

A3V Reflector, Titaness Light Shop, www.titanesslightshop.com/products-page/reflectors/a3v-reflector, online. Site visited Jan. 14, 2015.

G2V Grow Light Reflector, Titaness Light Shop, www.titanesslightshop.com/products-page/reflectors/g2v-grow-light-reflector, online. Site visited Jan. 14, 2015.

1000 Watt Galaxy Grow Amp Double Ended Grow Light Packages, image post date Jan. 30, 2014, site visited Jan. 8, 2016, <<http://www.ehydroponics.com/100-watt-galaxy-grow-amp-double-ended-grow-light-package.html>>.

2009-10-watt-light-set—TinEye, image post date May 23, 2012, site visited Jul. 8, 2016, <<https://www.tineye.com/search/2de39cf51f7a031139a80ce555e2f30d0abd5216/>>.

Square 10 Watt LED Grow Light, image post date Aug. 1, 2011, site visited Jul. 8, 2016, <<http://www.dhgate.com/store/product/hydroponic-vegetable-10-wattled-grow-light/216755031.html>>.

Sun System 630 Ceramic Metal Halide 120v Specifications, GrowersHouse.com, update on Sep. 9, 2014, Online, Site visited Feb. 3, 2015. <http://growershouse.com/aitdownloadablefiles/download/aitfile/aitfile_id/583/>.

Growlite HDE 600W-1000W Double Ended Lamp Concealed Vacuum Airflow Technology, Indoor Grow Science, site visited Aug. 3, 2016, <<http://www.indoorgrowscience.net/downloads/specs/hde.pdf>>.

Sun Systems LEC 315—Reviews?, rollitup.com forum, published Oct. 23, 2013, online. Visited Nov. 8, 2016. <<http://rollitup.org/t/sun-systems-lec-315-reviews.742794>>.

Sun System LEC 315 120v Light Emitting Ceramic Metal Halide Fixture w/ Free Ratchet Light Hangers, Amazon.com, earliest review of Jul. 2, 2014, online. Visited Nov. 8, 2016 <<https://www.amazon.com/sun-system-emitting-ceramic-fixture/dp/B00HBCV8TM>>.

LEC 315 Watt Grow Light Great Yield Reports!, YouTube.com, published Mar. 31, 2014, online. Visited Nov. 8, 2016. <<https://www.youtube.com/watch?v=QqcoW19KnUk>>.

Air Cooled Grow Lights, greensteamhydroponics.com, published May 24, 2014, online. Site visited Nov. 16, 2016. <http://web.archive.org/web/20140524103407/http://www.greensteamhydroponics.com/aircooled-reflector-range-from-greenstream-hydroponics/prod_699.html>.

AplusChoice—hydroponics, image post date Dec. 2, 2014, site visited Jul. 13, 2017, (online), <https://www.tineye.com/search/6589596c8738268de70acceca20d64855d0f1d2/?sort=crawal_date&order=asc>.

(56)

References Cited

OTHER PUBLICATIONS

Power 600 wat HPS MH Grow Light Digital Dimm System Indoor Garden Set, image post date 2013, site visited Jul. 13, 2017, (online), <https://bidjapon.com/item_View.aspx?itemId=150928769289>.

* cited by examiner

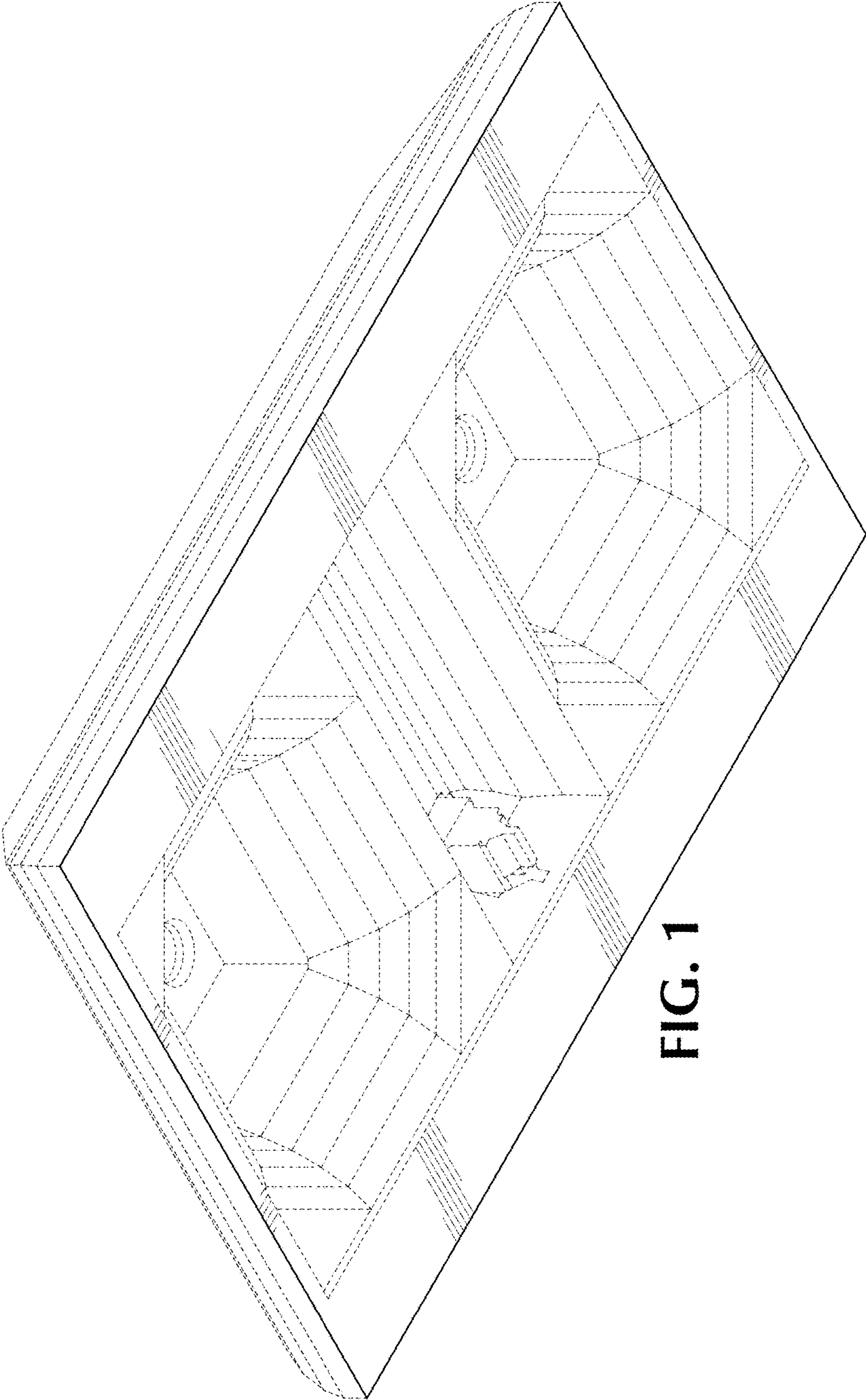

FIG. 1

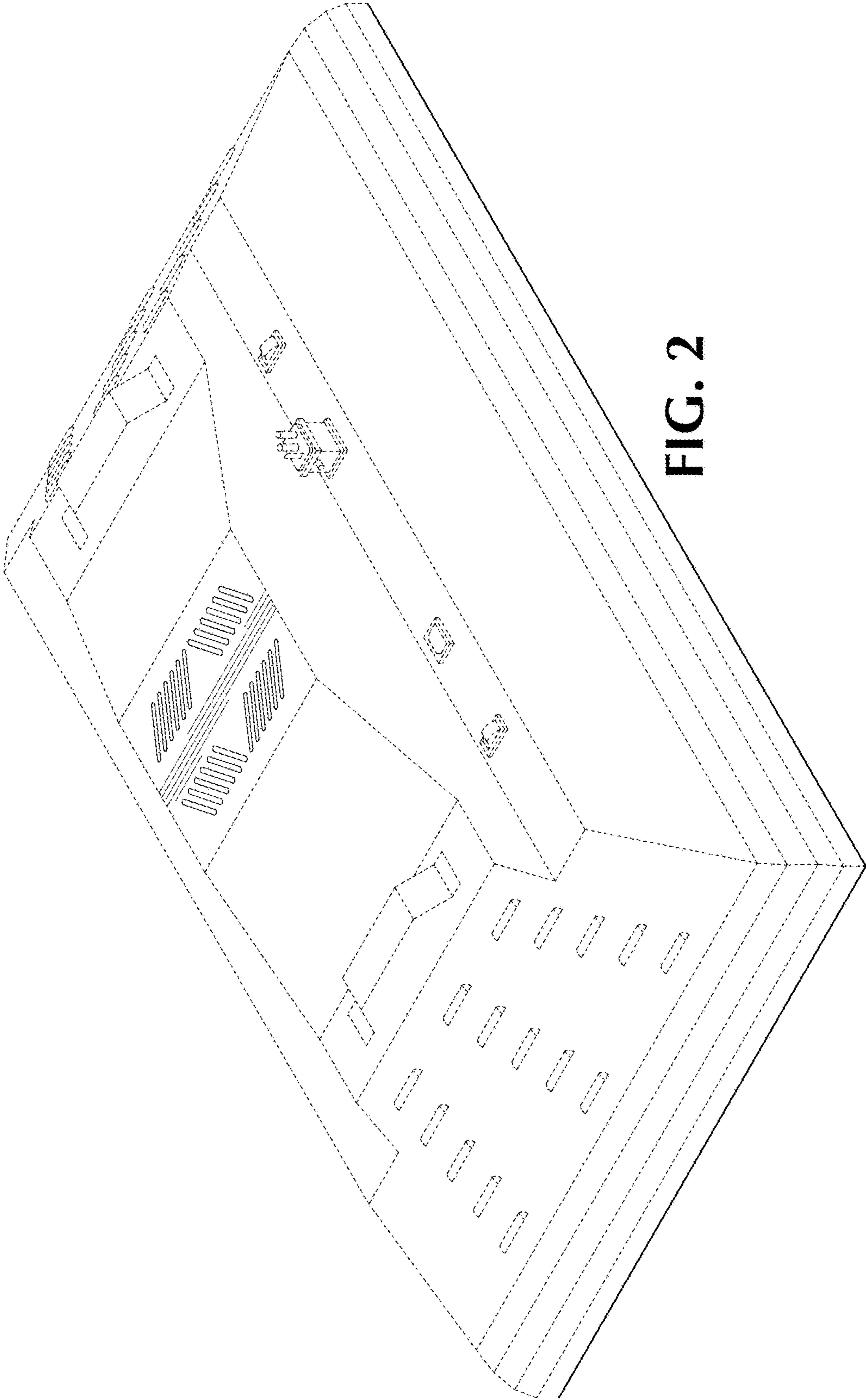

FIG. 2

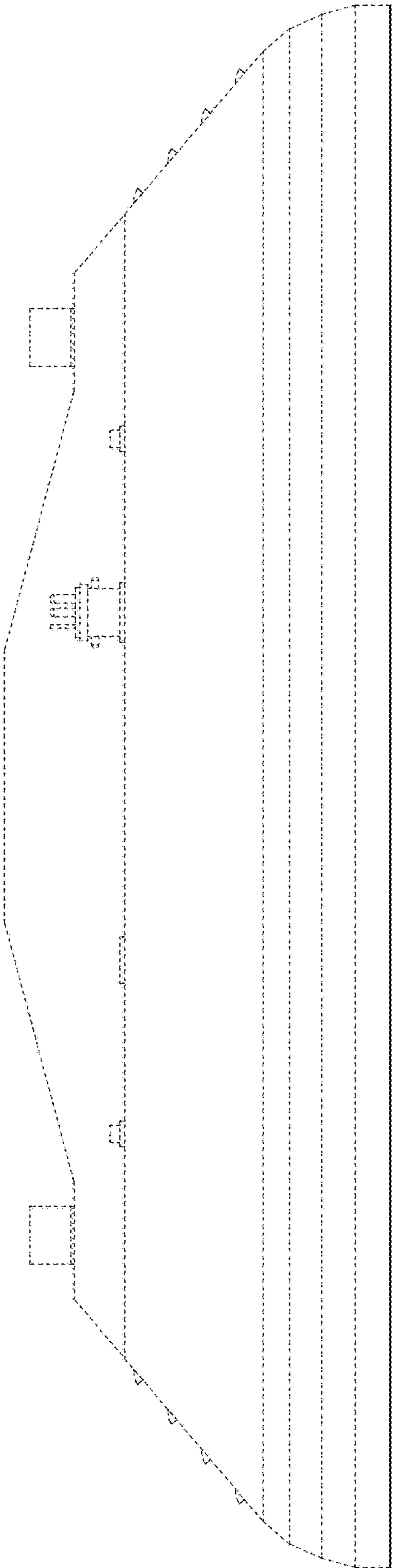

FIG. 3

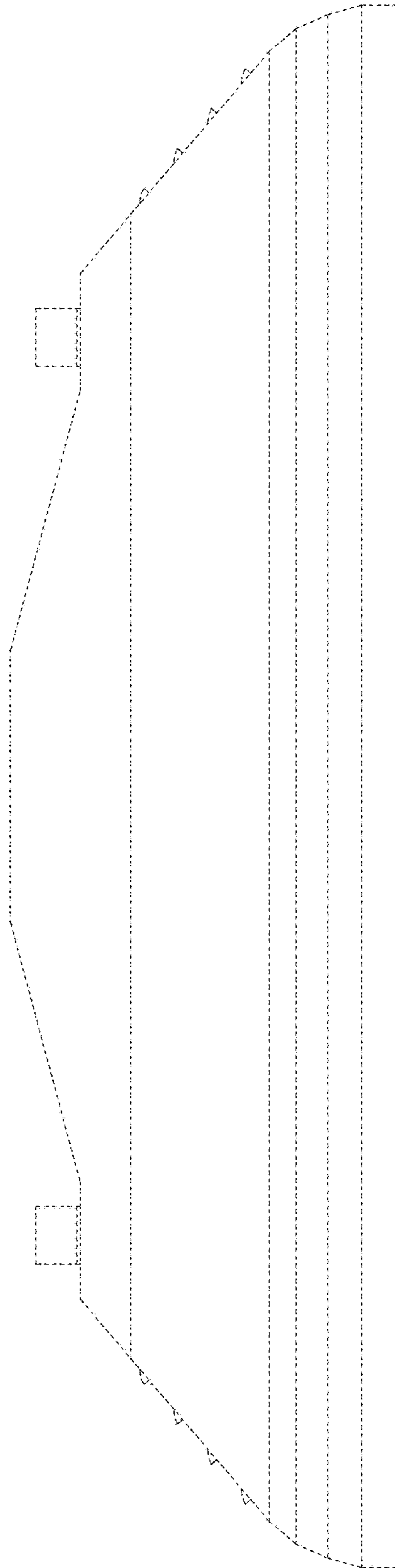

FIG. 4

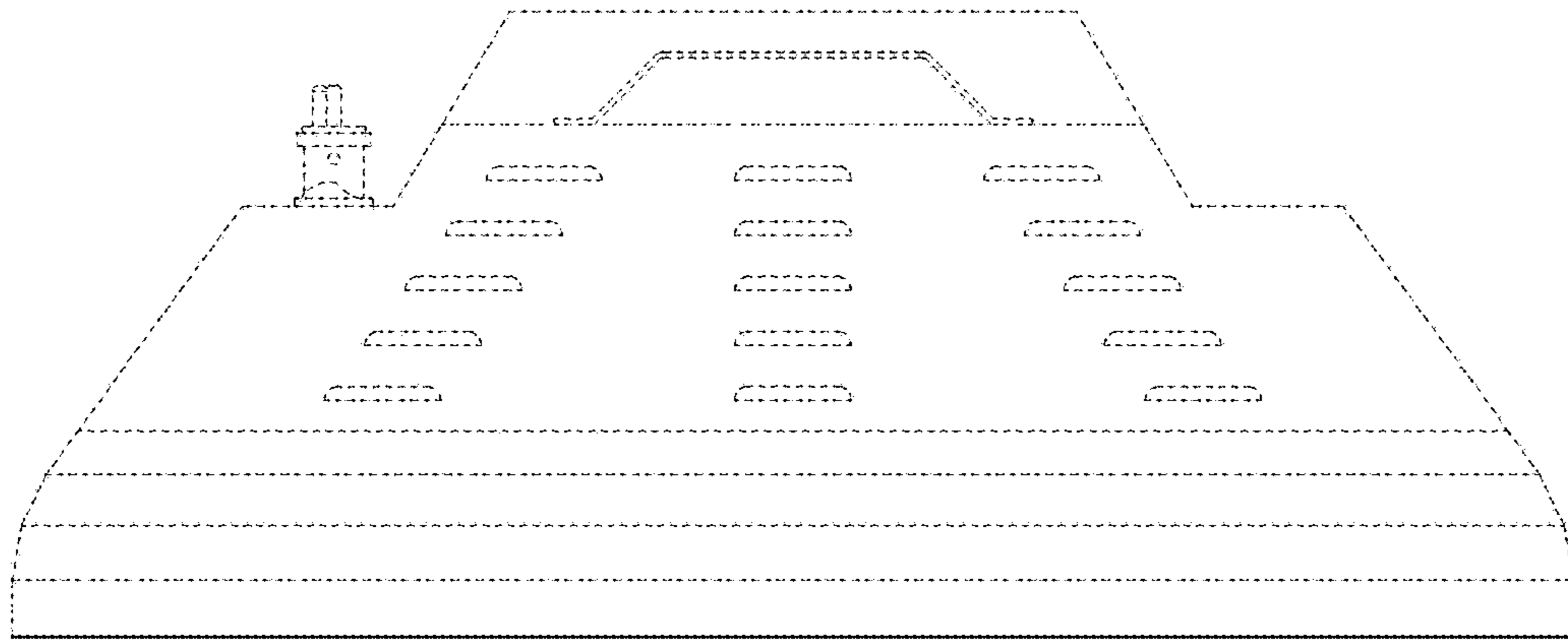

FIG. 5

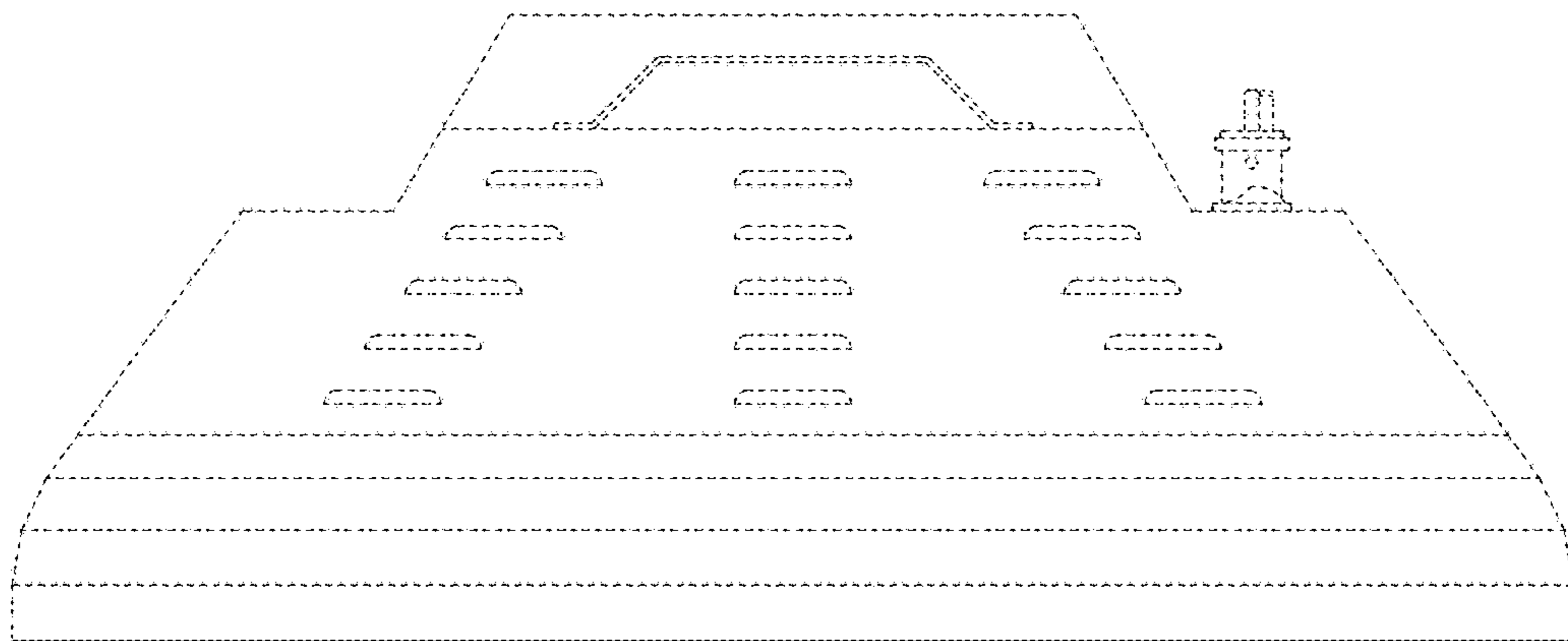

FIG. 6

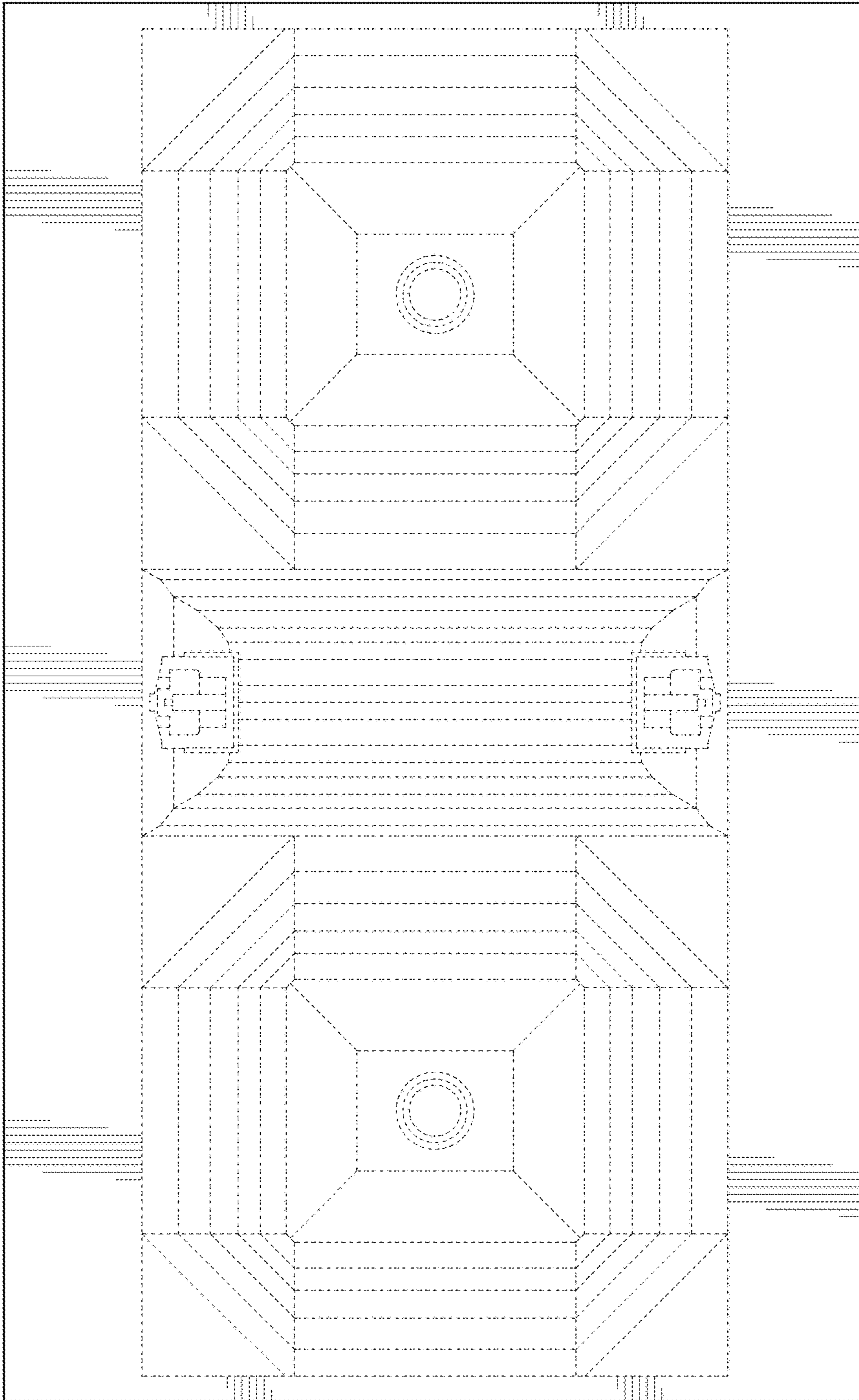

FIG. 7

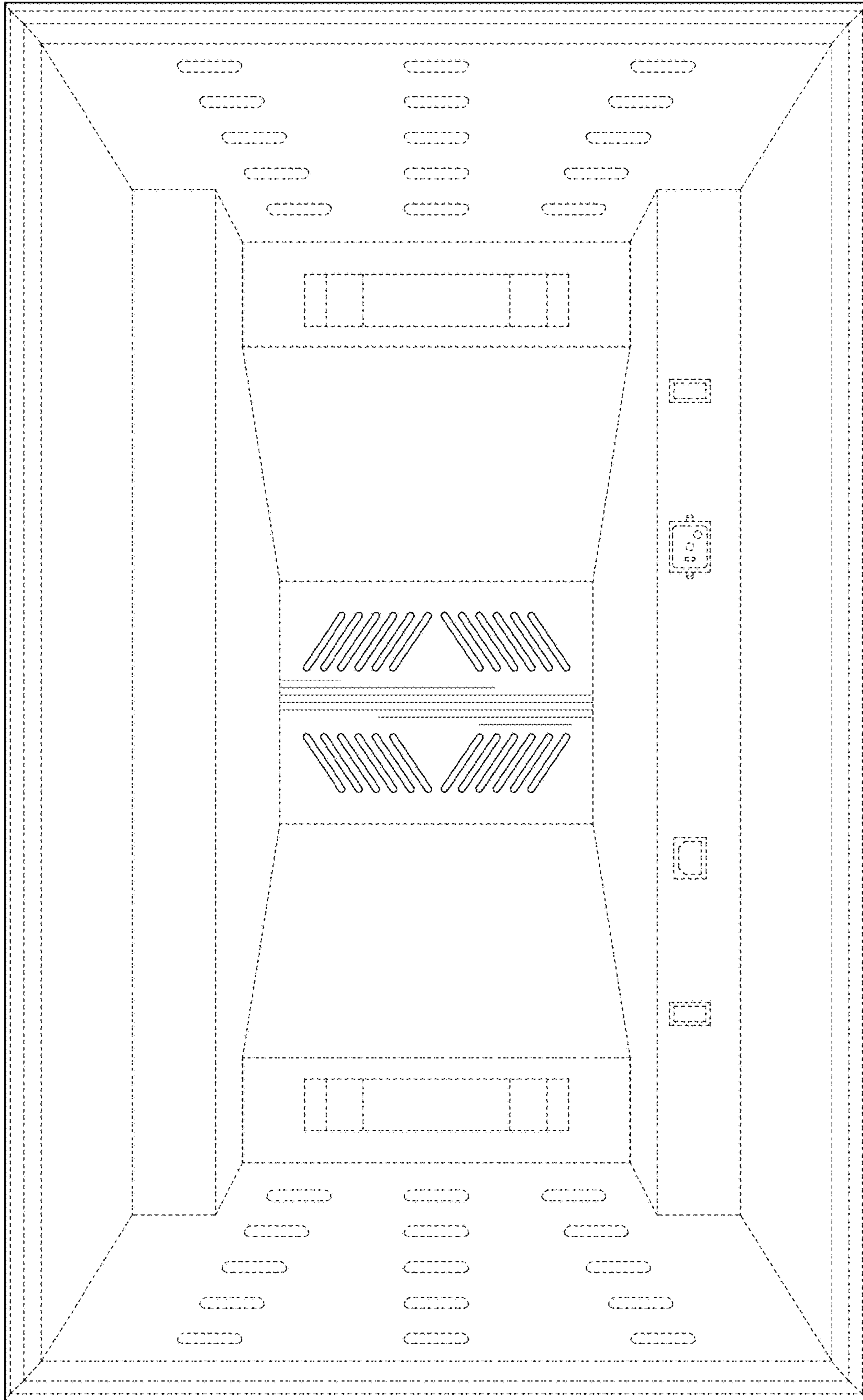

FIG. 8