



US00D826431S

(12) **United States Design Patent**
Pleso et al.

(10) **Patent No.:** **US D826,431 S**

(45) **Date of Patent:** **** Aug. 21, 2018**

(54) **INTERFACE FOR AN ELECTRONIC UNIT**

(56) **References Cited**

(71) Applicant: **Cisco Technology, Inc.**, San Jose, CA
(US)

U.S. PATENT DOCUMENTS

(72) Inventors: **Benjamin Thomas Pleso**, Richfield,
OH (US); **Daniel Neal Johnson**,
Louisville, OH (US)

D509,309 S *	9/2005	Janssen	D26/1
D578,670 S *	10/2008	Li	D26/1
D636,900 S *	4/2011	Chou	D26/1
D645,984 S *	9/2011	Wang	D26/1

(73) Assignee: **Cisco Technology, Inc.**, San Jose, CA
(US)

* cited by examiner

Primary Examiner — Marcus Jackson

(**) Term: **15 Years**

(74) *Attorney, Agent, or Firm* — Patterson + Sheridan,
LLP

(21) Appl. No.: **29/611,089**

(57) **CLAIM**

The ornamental design for an interface for an electronic unit,
as shown and described.

(22) Filed: **Jul. 18, 2017**

DESCRIPTION

Related U.S. Application Data

(62) Division of application No. 29/565,479, filed on May
20, 2016, now Pat. No. Des. 808,546.

(51) **LOC (11) Cl.** **26-04**

(52) **U.S. Cl.**
USPC **D26/1**

(58) **Field of Classification Search**
USPC D26/1-4; 313/313, 315, 316, 317, 318,
313/493; 315/52, 53, 56, 57, 58
CPC H01R 5/00; H01R 13/46; H01R 13/514;
H01R 31/048; H01R 31/02; H01J 5/00;
H01J 5/16; H01J 15/00; H01J 5/48; H01J
5/50; H01J 19/54; F21V 5/00

See application file for complete search history.

FIG. 1 is a top front perspective view of an interface for an
electronic unit, showing our new design;
FIG. 2 is a bottom front perspective view thereof;
FIG. 3 is an enlarged perspective view of a portion thereof;
FIG. 4 is another enlarged perspective view of the portion
thereof;
FIG. 5 is an enlarged front elevational view of the portion
thereof;
FIG. 6 is a front elevational view thereof;
FIG. 7 is a right side elevational view thereof;
FIG. 8 is a rear elevational view thereof;
FIG. 9 is a left side elevational view thereof;
FIG. 10 is a top plan view thereof; and,
FIG. 11 is a bottom plan view thereof.
The portions illustrated in broken lines form no part of the
claimed design.

1 Claim, 9 Drawing Sheets

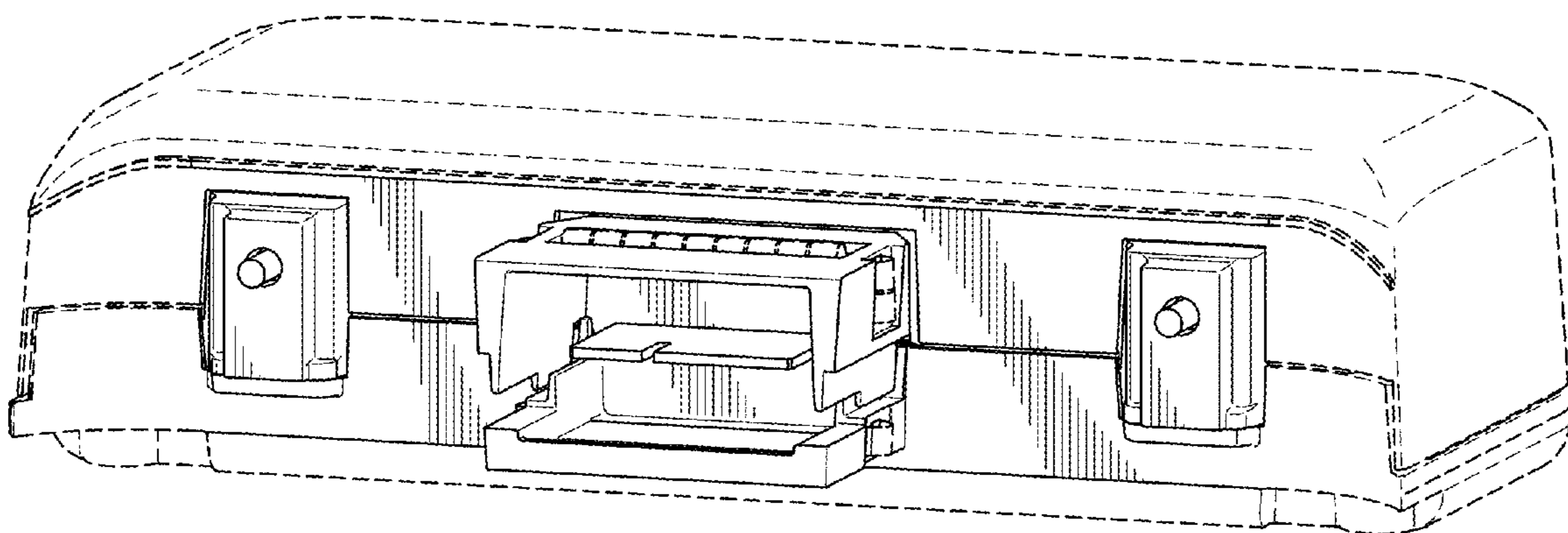

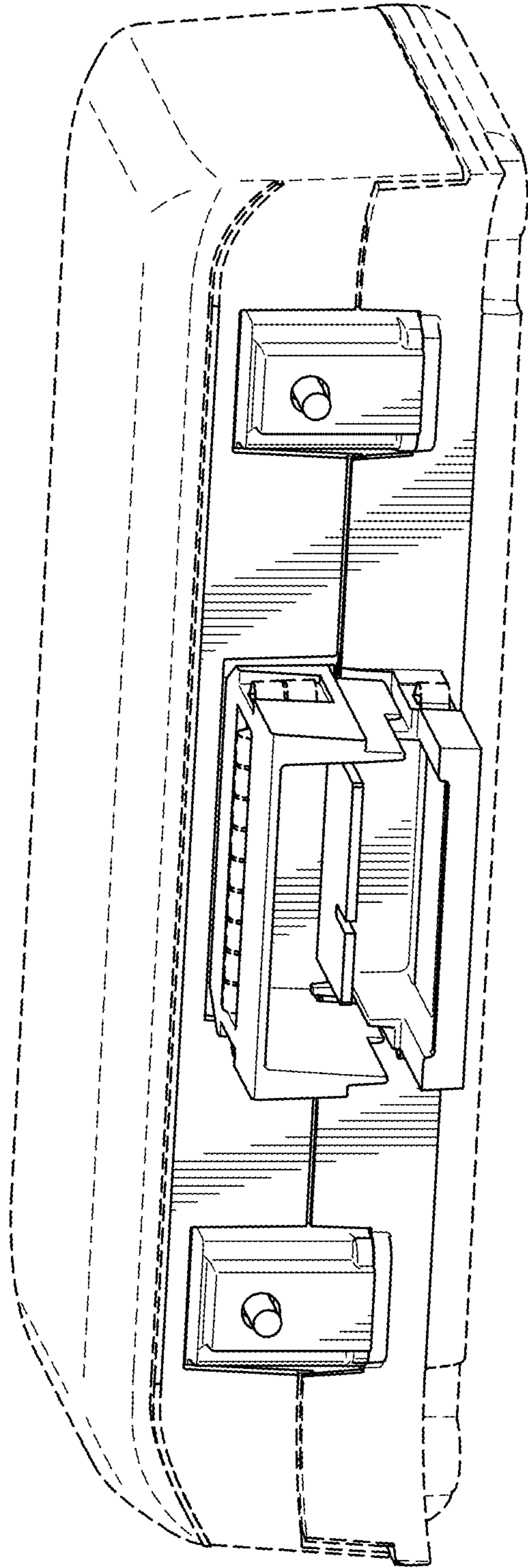

Fig. 1

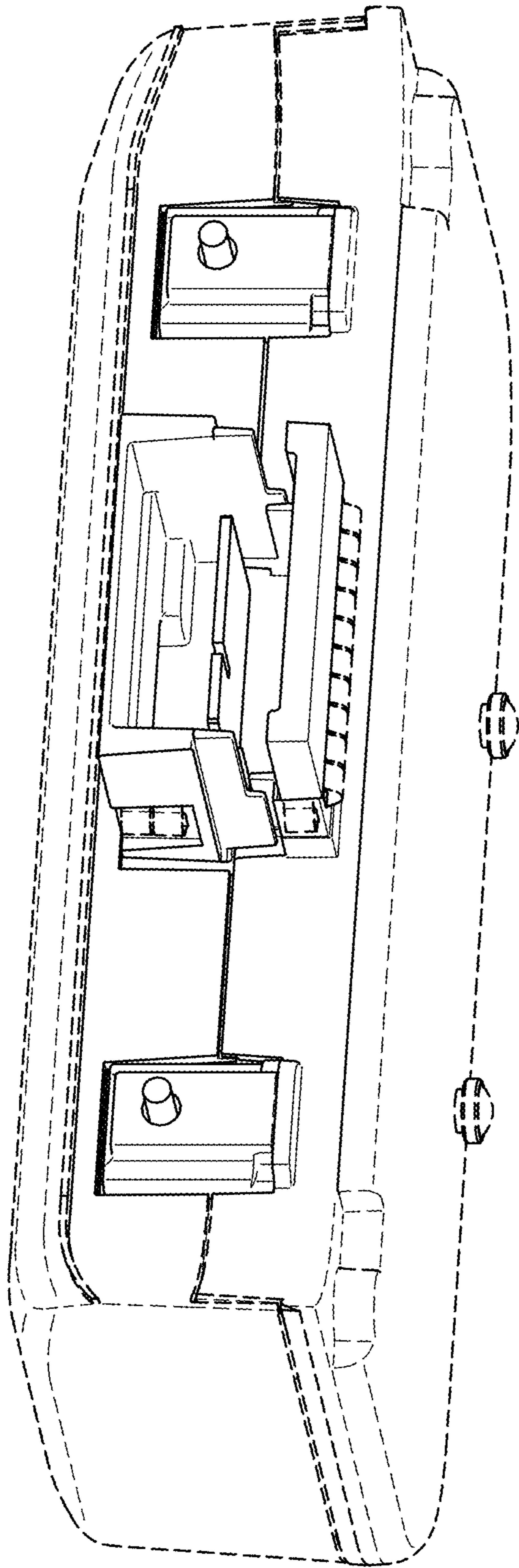

Fig. 2

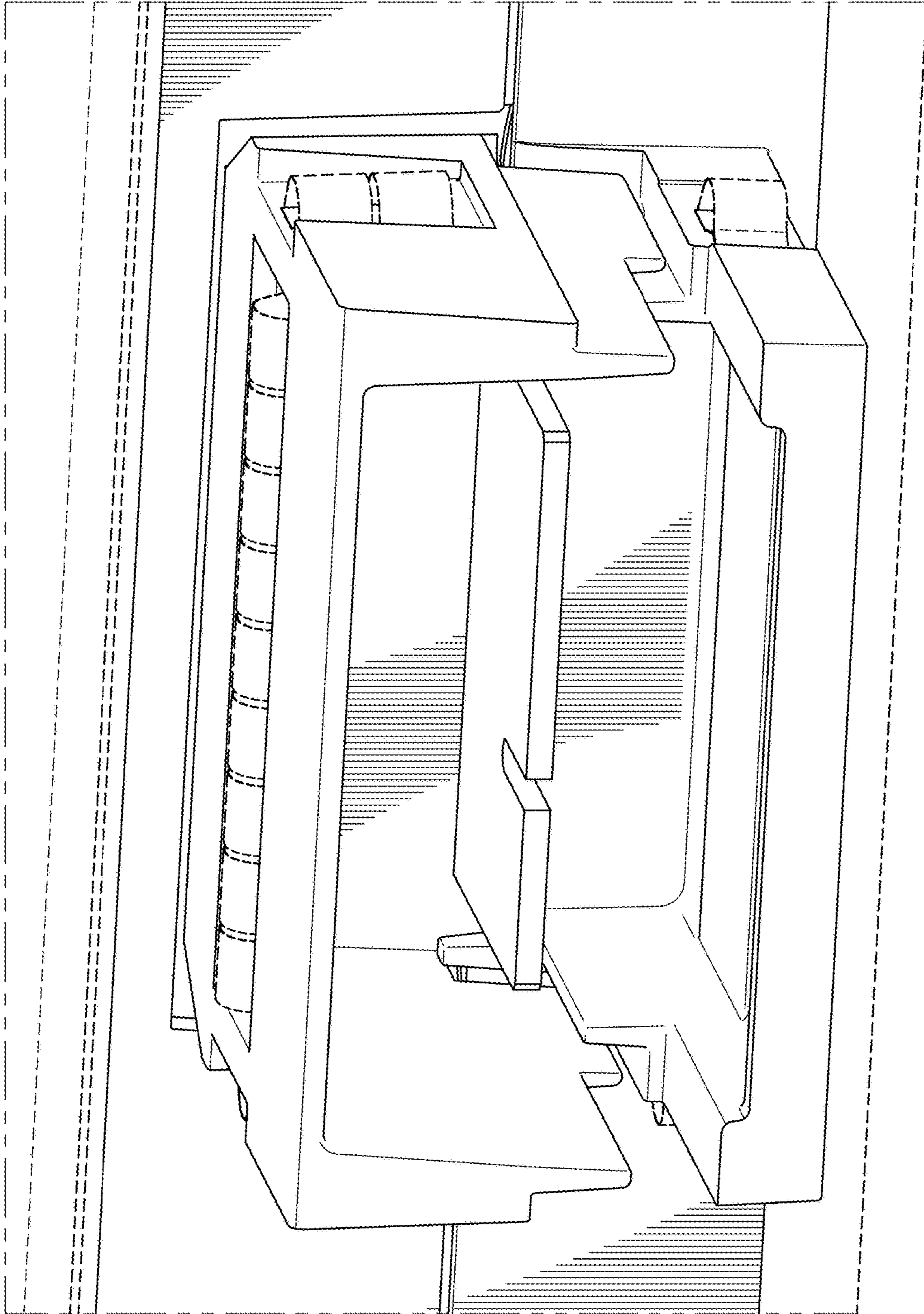
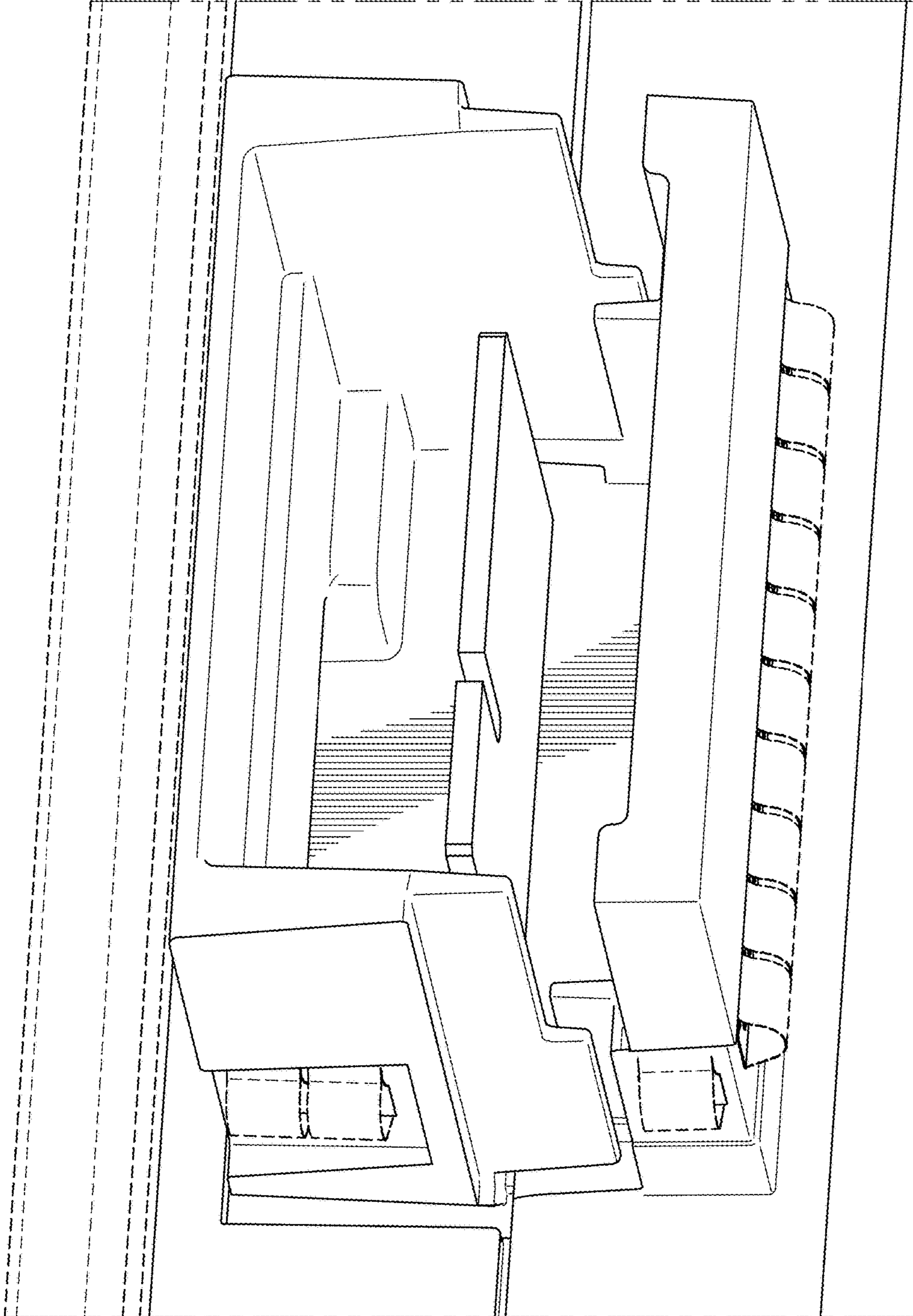

Fig. 3

Fig. 4



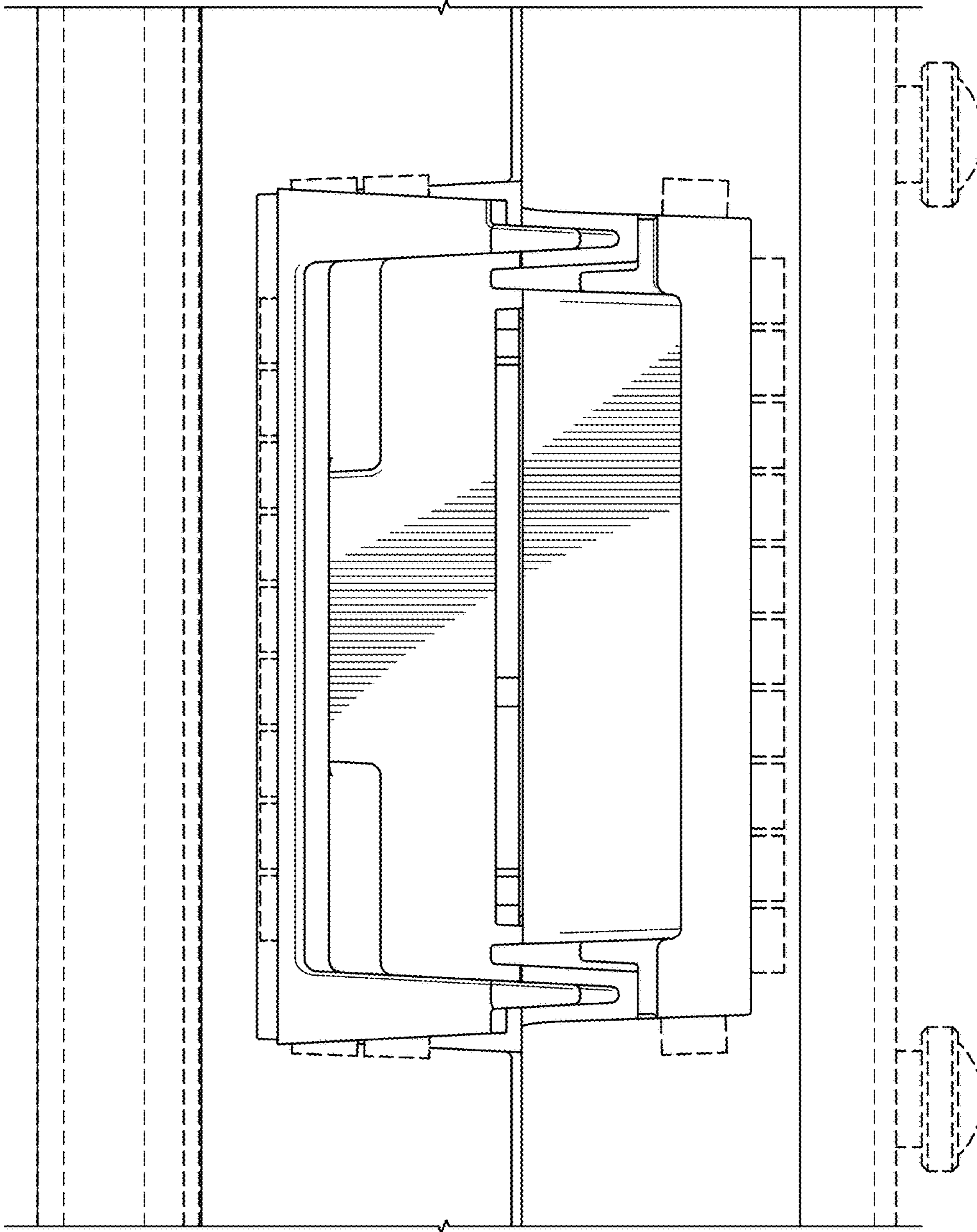

Fig. 5

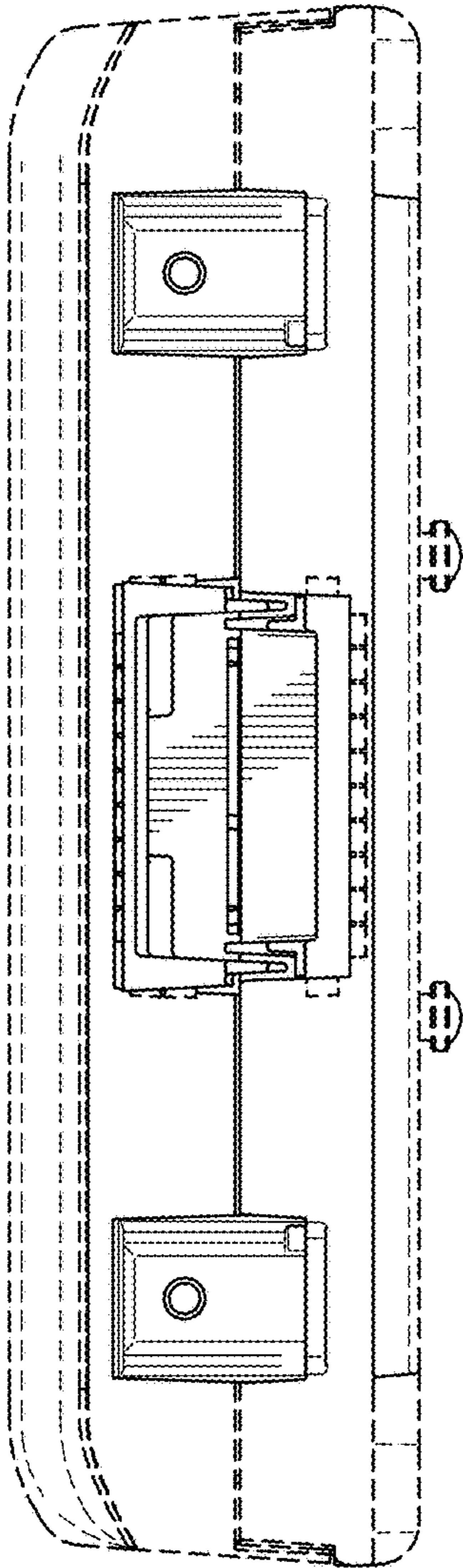

Fig. 6

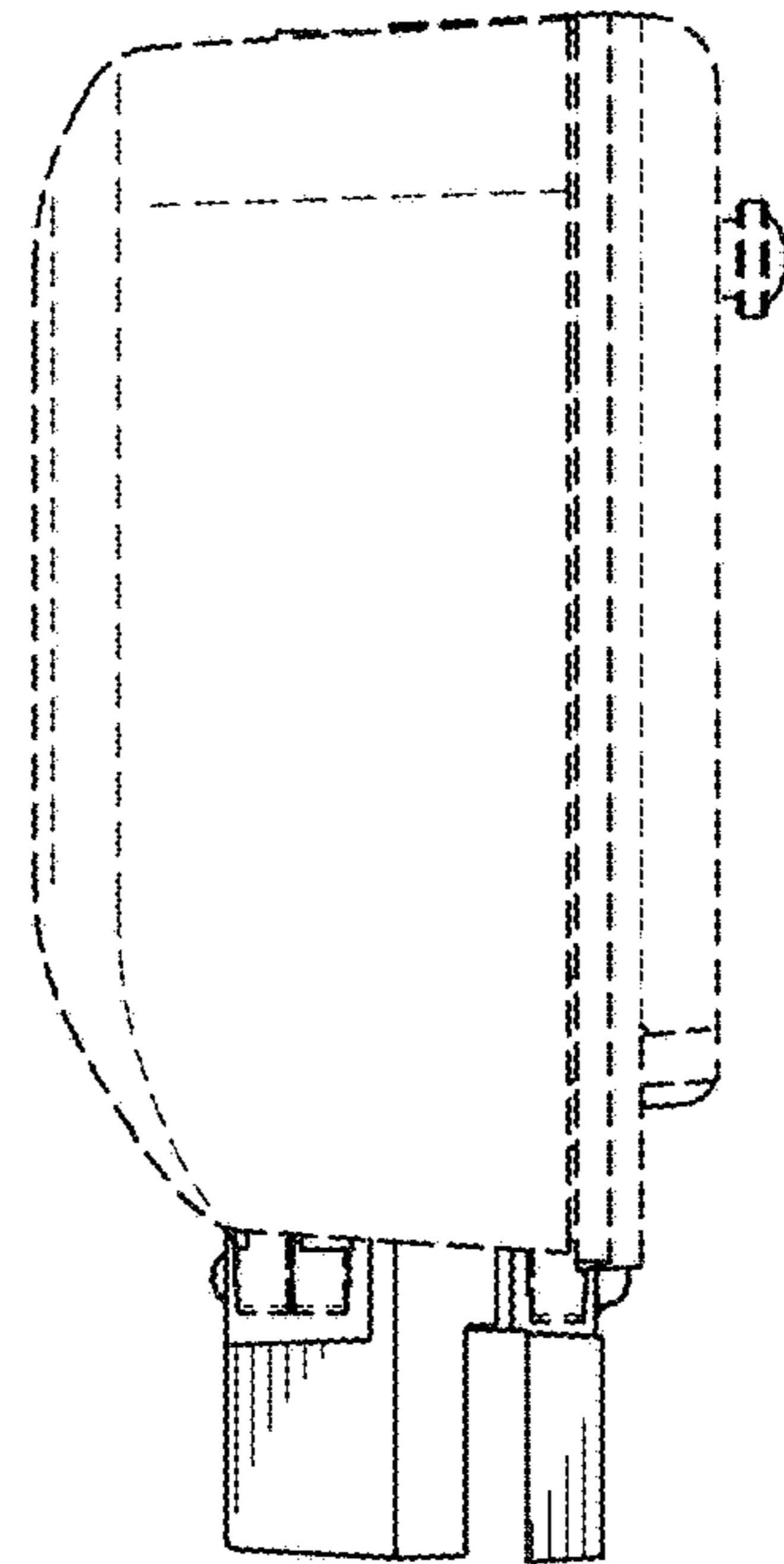

Fig. 7

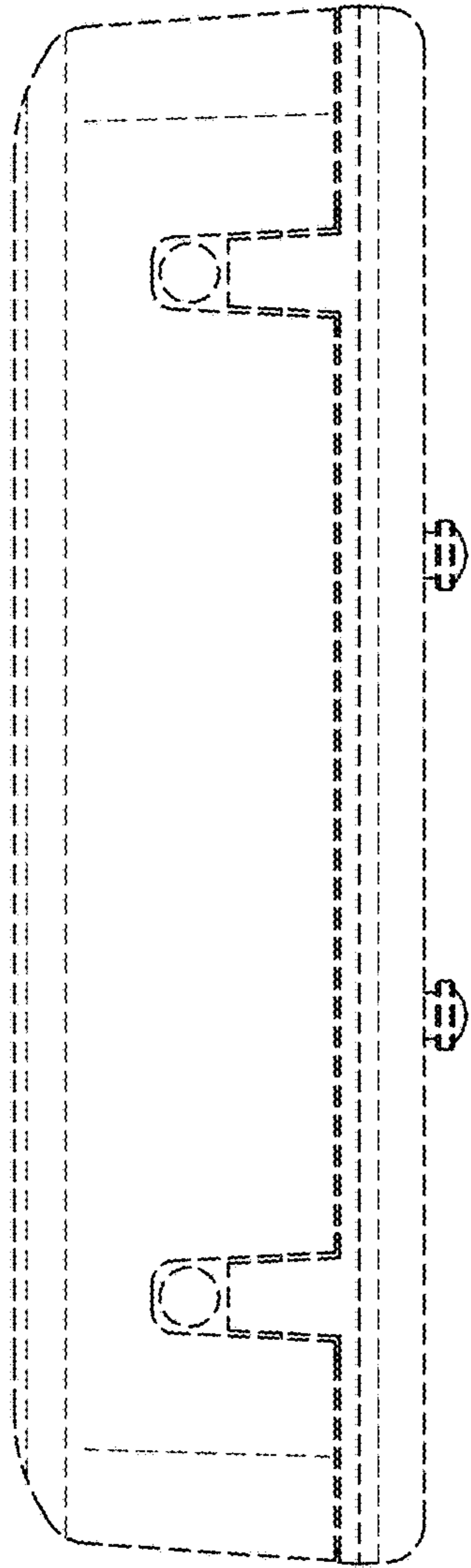

Fig. 8

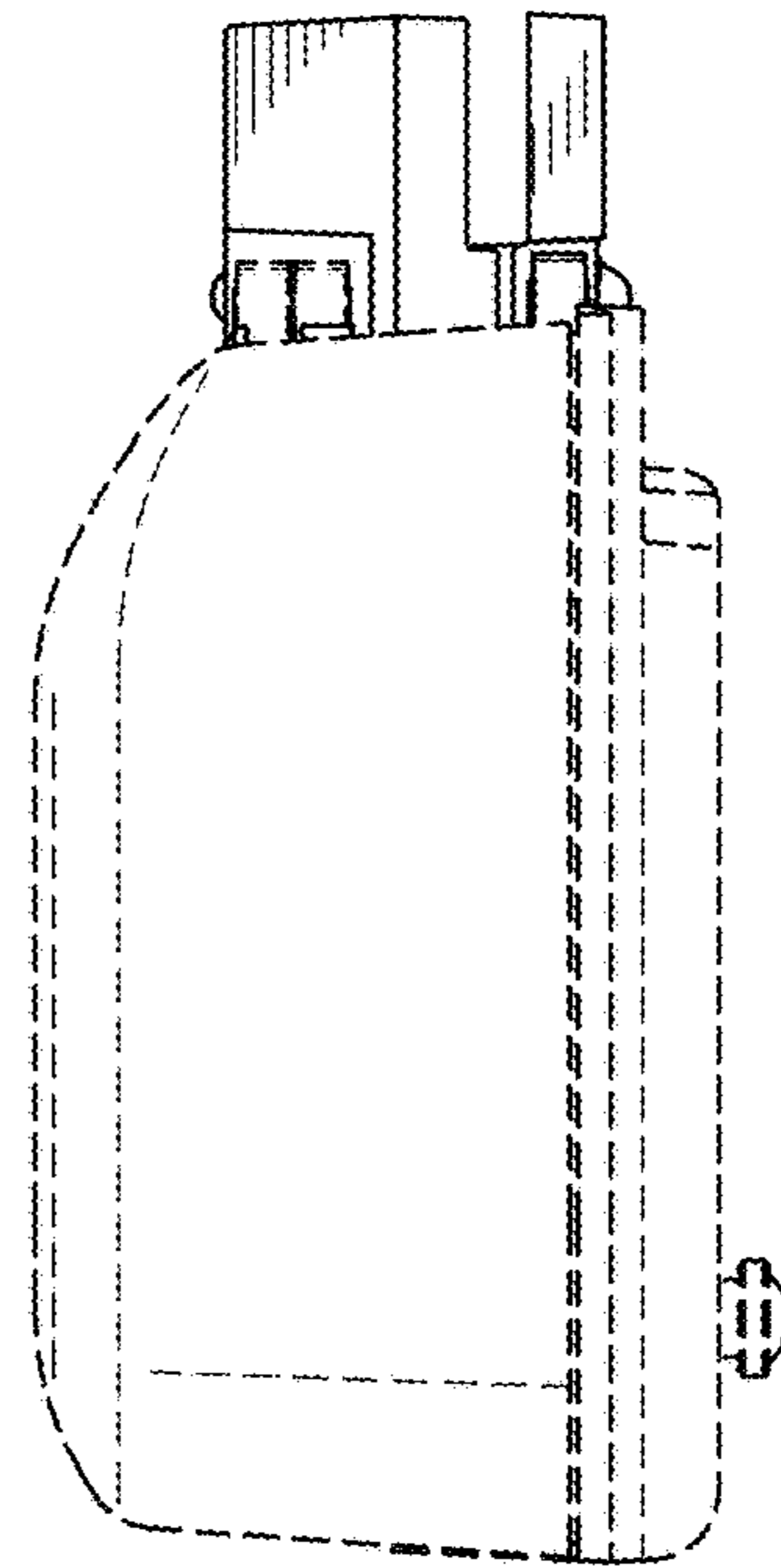

Fig. 9

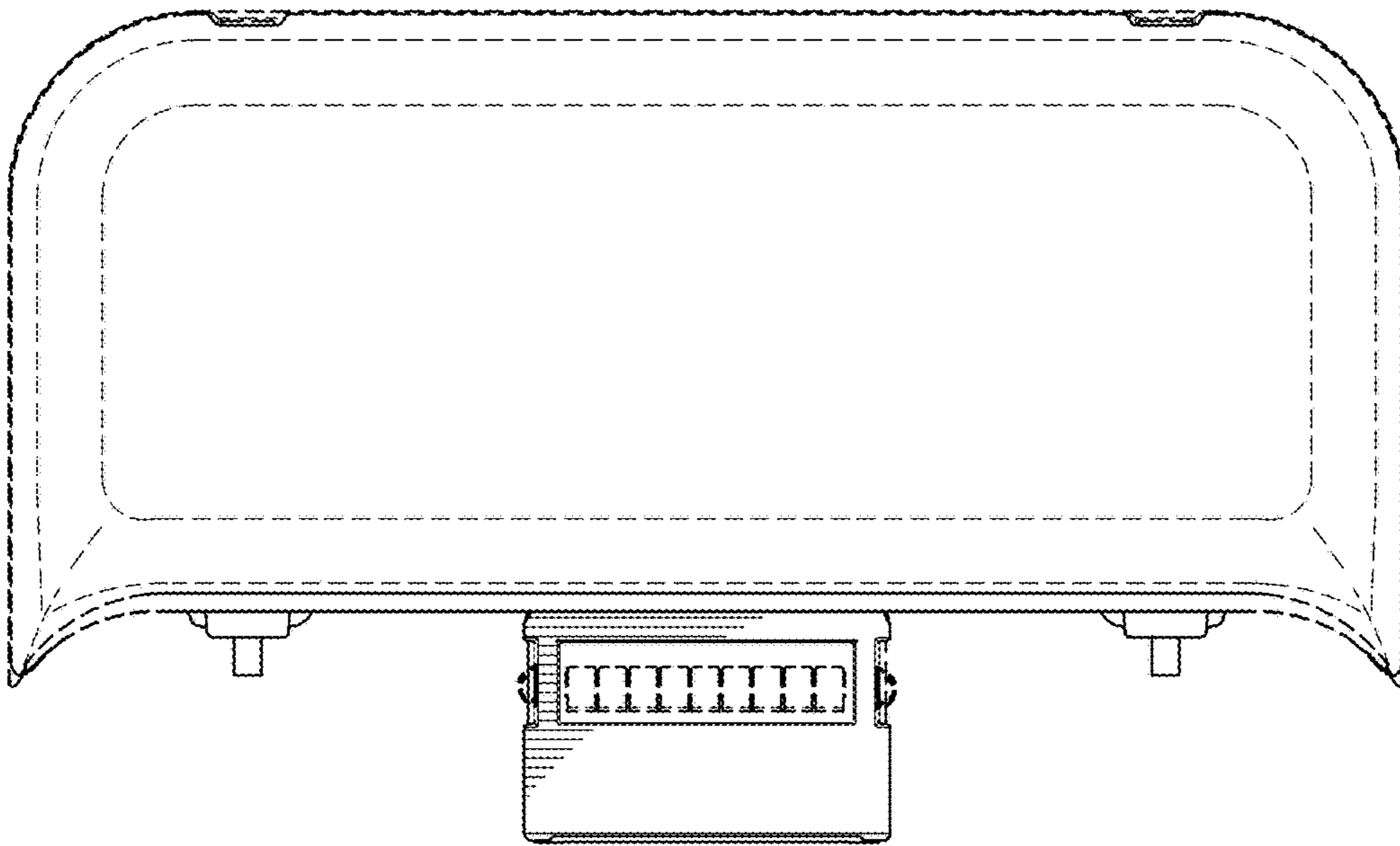

Fig. 10

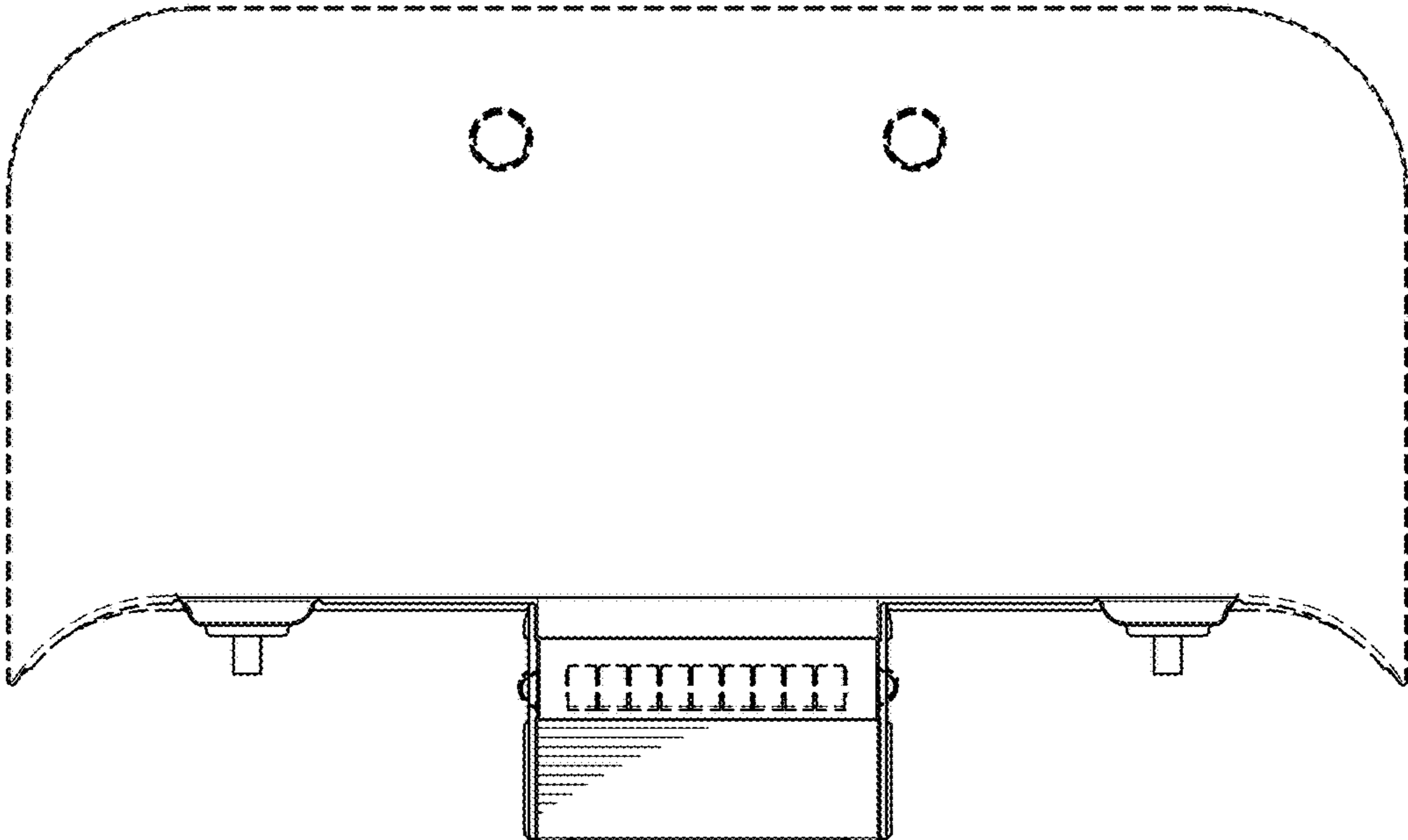

Fig. 11