



US00D826387S

(12) **United States Design Patent**
Masuda et al.

(10) **Patent No.:** **US D826,387 S**
(45) **Date of Patent:** **** Aug. 21, 2018**

- (54) **TOILET SEAT WITH BIDET**
- (71) Applicants: **AISIN SEIKI KABUSHIKI KAISHA**,
Kariya-shi, Aichi-ken (JP); **LIXIL CORPORATION**, Tokyo (JP)
- (72) Inventors: **Takumi Masuda**, Kiyosu (JP); **Hideaki Tsuzuki**, Tokyo (JP); **Daisuke Matsumoto**, Tokyo (JP)
- (73) Assignees: **AISIN SEIKI KABUSHIKI KAISHA**,
Kariya-Shi, Aichi-Ken (JP); **LIXIL CORPORATION**, Tokyo (JP)

D620,568 S *	7/2010	Giovannoni	D23/311
D659,812 S *	5/2012	Shek	D23/311
D688,359 S *	8/2013	Ogata	D23/311
D691,249 S *	10/2013	Obara	D23/311
D704,317 S *	5/2014	Shinozaki	D23/311

(Continued)

FOREIGN PATENT DOCUMENTS

JP	D1481472 S	10/2013
KR	D30-0808893 S	8/2015
KR	D30-0864123 S	7/2016

OTHER PUBLICATIONS

Official Action (“Notification of Reasons for Rejection”) by the Japanese Patent Office (JPO) dated Jun. 2, 2017 in the counterpart Japanese Application No. 2016-025457 with English translation thereof (6 pages).

Primary Examiner — Celia A Murphy

Assistant Examiner — John A Voytek

(74) *Attorney, Agent, or Firm* — Buchanan Ingersoll & Rooney PC

- (**) **Term:** **15 Years**
- (21) **Appl. No.:** **29/604,503**
- (22) **Filed:** **May 18, 2017**

(30) **Foreign Application Priority Data**

Nov. 23, 2016 (JP) 2016-025457

- (51) **LOC (11) Cl.** **23-02**
- (52) **U.S. Cl.**
USPC **D23/311**
- (58) **Field of Classification Search**
USPC D23/295–303, 307, 309, 310, 311, 313;
D6/349, 354, 356, 601, 611, 716.4, 716.5;
D21/414, 415; D24/200
CPC A47K 11/00; A47K 13/00; Y10S 4/05;
A47G 9/10
See application file for complete search history.

(56) **References Cited**

U.S. PATENT DOCUMENTS

D355,246 S *	2/1995	Kawamura	D23/295
D463,853 S *	10/2002	Yamanaka	D23/311
D557,391 S *	12/2007	Kaule	D23/311
D571,904 S *	6/2008	Kaule	D23/311
D572,808 S *	7/2008	Zhou	D23/311
D617,884 S *	6/2010	Choi	D23/311

(57) **CLAIM**

The ornamental design for a toilet seat with bidet, as shown and described.

DESCRIPTION

FIG. 1 is a front perspective view of a toilet seat with bidet showing our new design;
FIG. 2 is a rear perspective view thereof;
FIG. 3 is a front view thereof;
FIG. 4 is a rear view thereof;
FIG. 5 is a top plan view thereof;
FIG. 6 is a bottom plan view thereof;
FIG. 7 is a right side view thereof; and,
FIG. 8 is a left side view thereof.
The broken line showing in the drawings is for environmental purposes and forms no part of the claimed design.

1 Claim, 8 Drawing Sheets

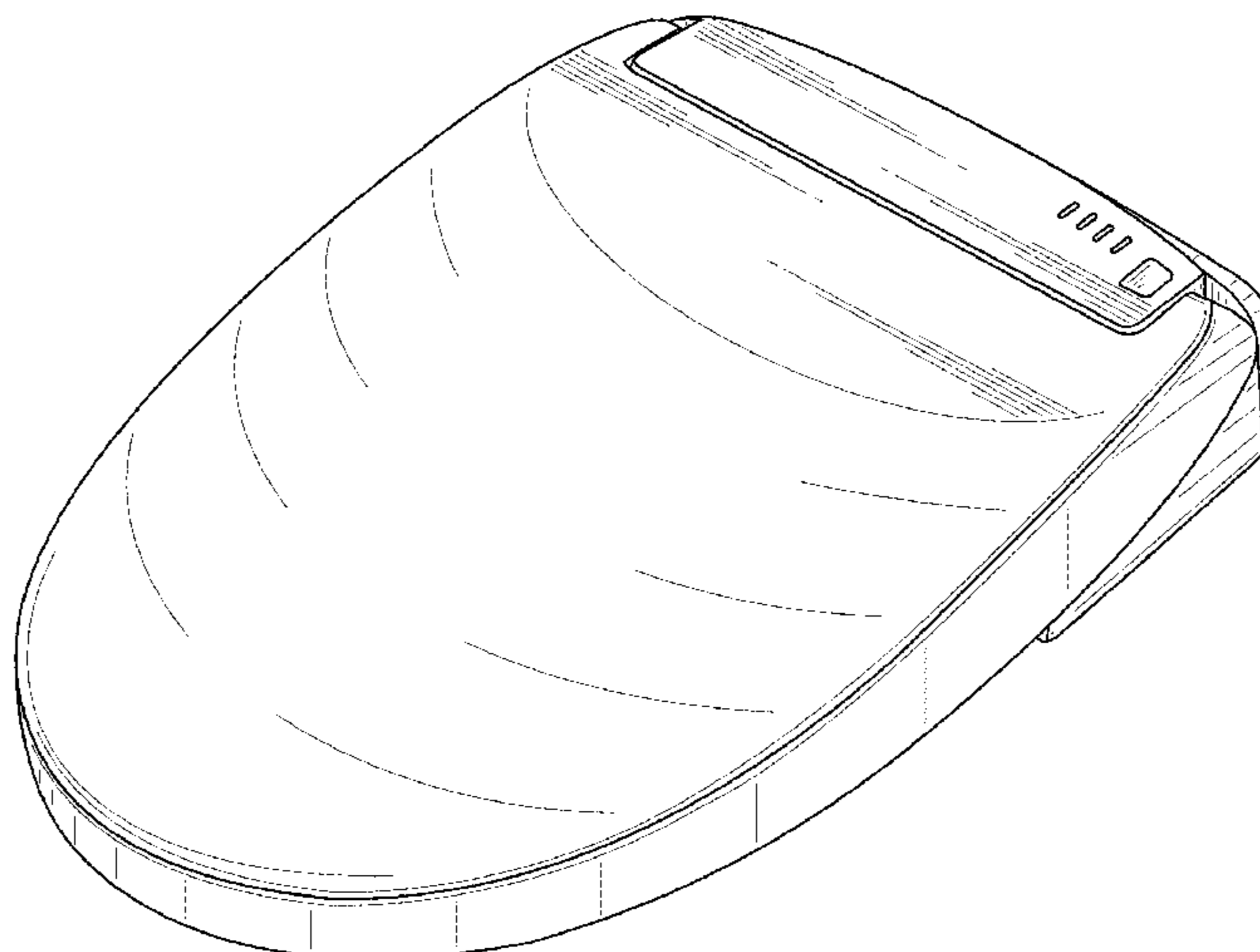

(56)

References Cited

U.S. PATENT DOCUMENTS

D764,643 S * 8/2016 Nakabayashi D23/311
D786,412 S * 5/2017 Jeong D23/311

* cited by examiner

FIG. 1

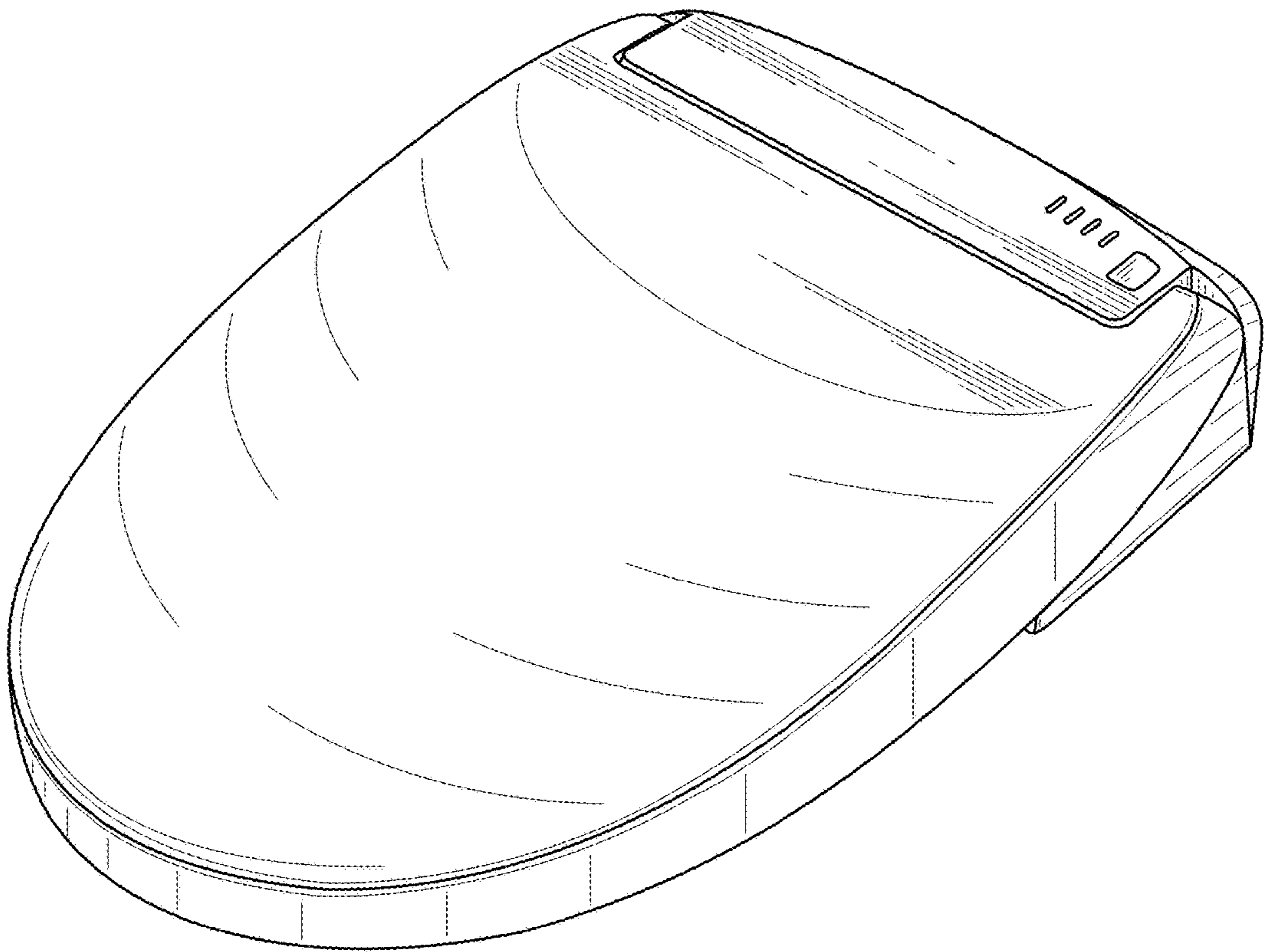

FIG. 2

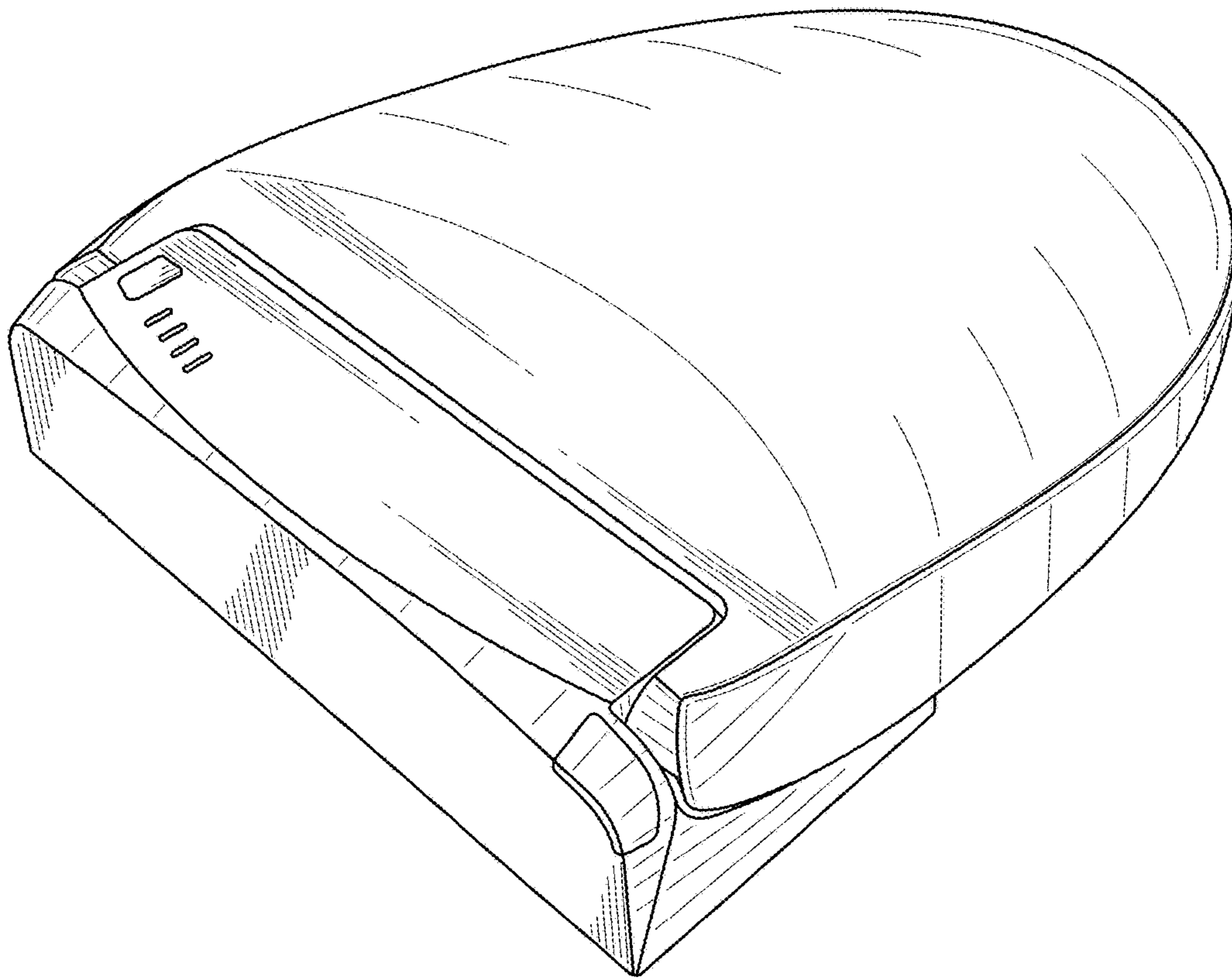

FIG. 3

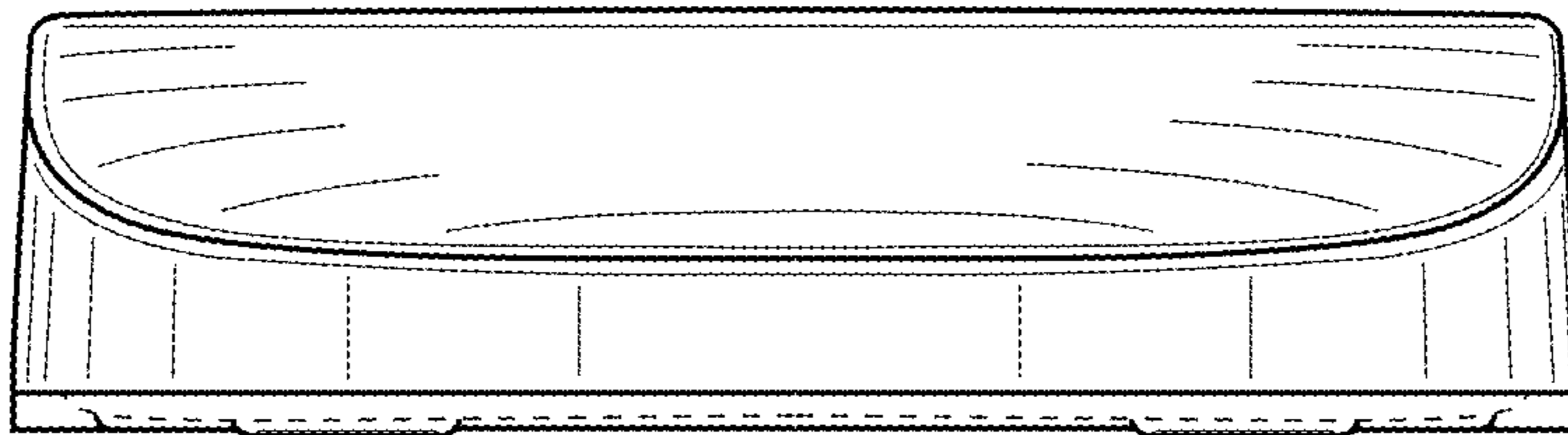

FIG. 4

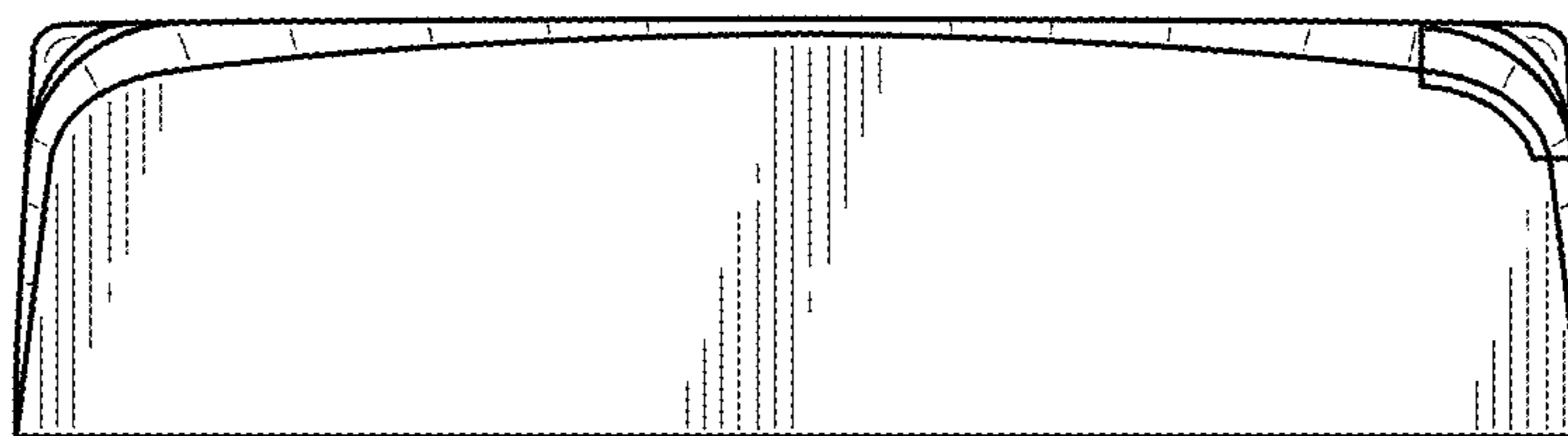

FIG. 5

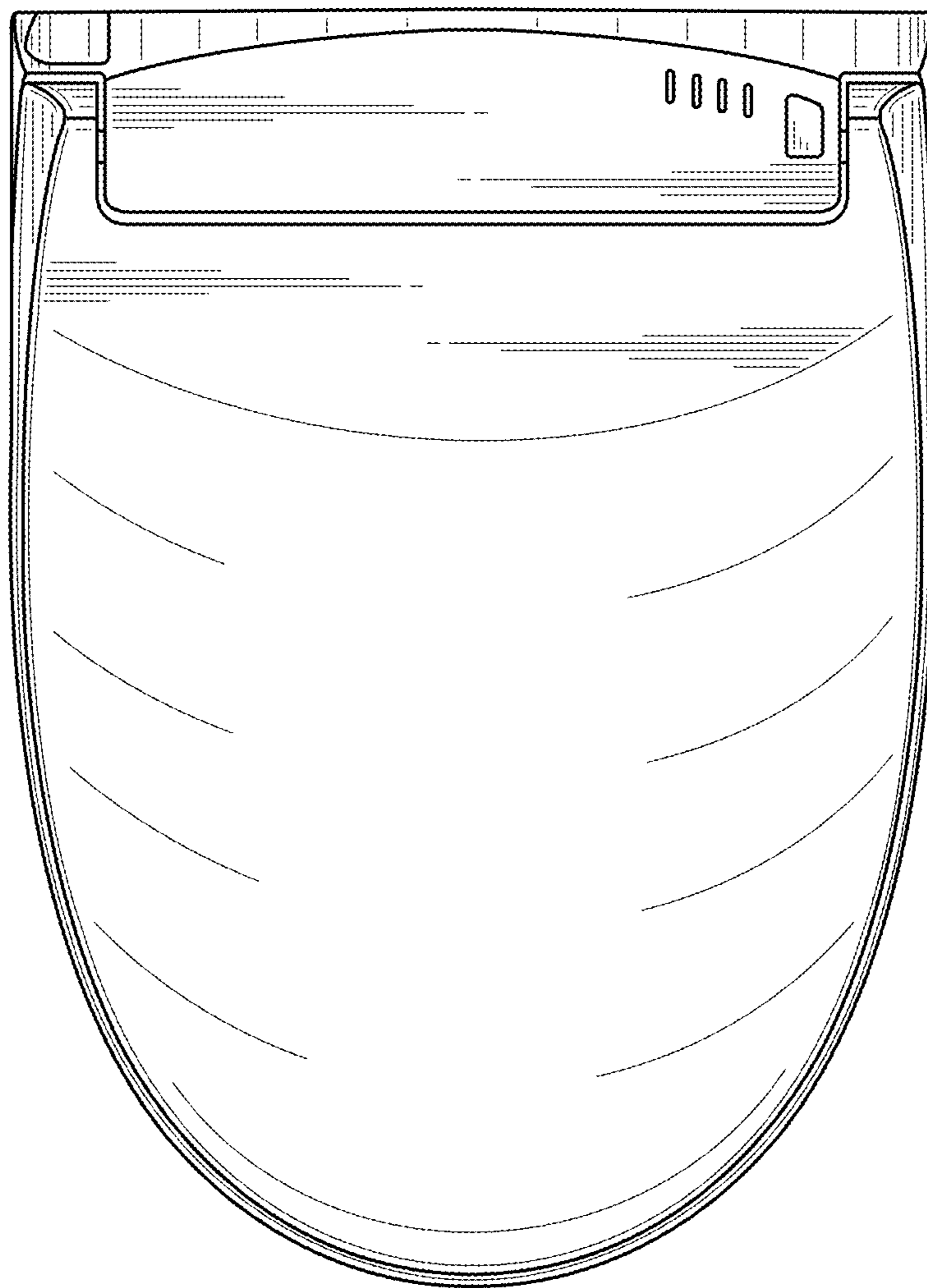

FIG. 6

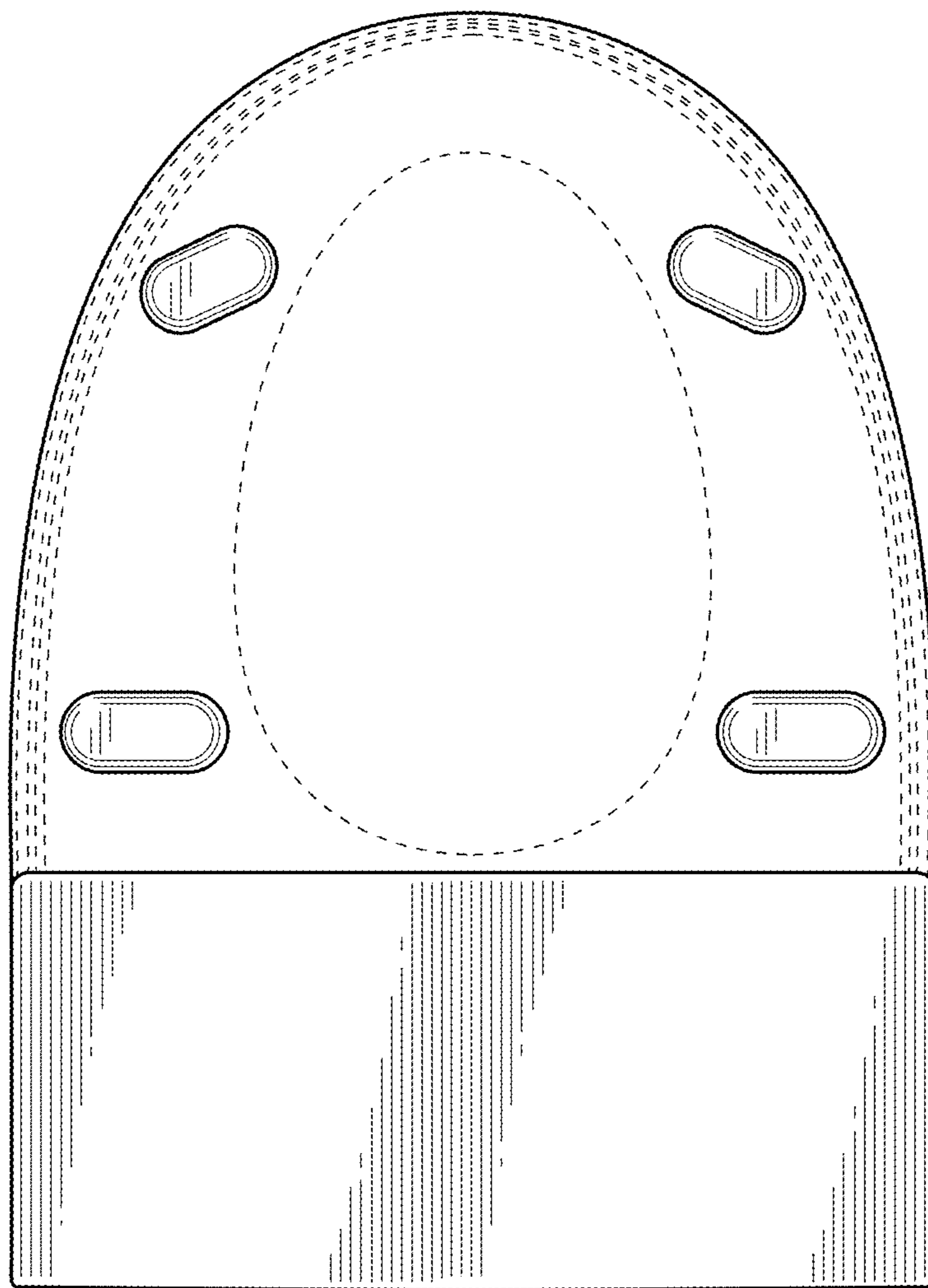

FIG. 7

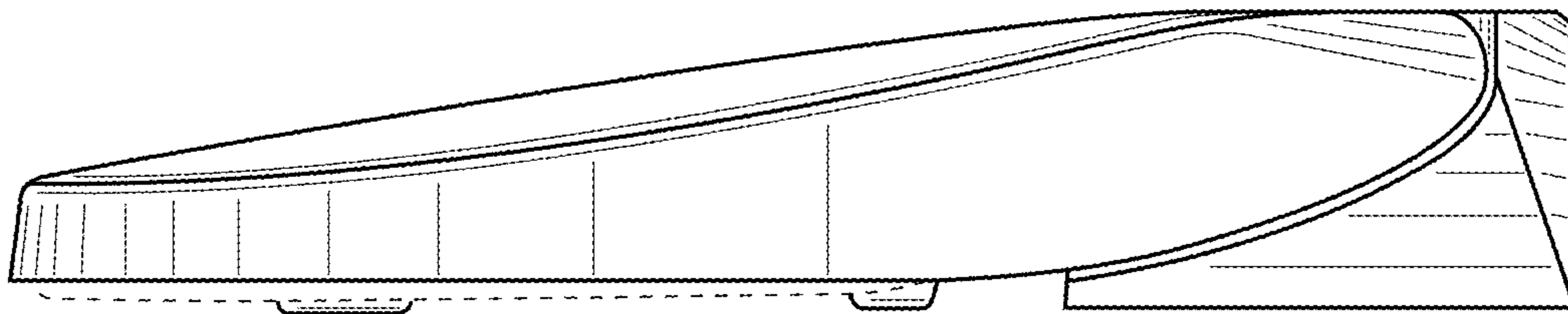

FIG. 8

