



US00D826307S

(12) **United States Design Patent**
Yoshizawa et al.

(10) **Patent No.:** **US D826,307 S**
(45) **Date of Patent:** **** Aug. 21, 2018**

(54) **INTERCHANGEABLE LENS FOR CAMERA**

(71) Applicant: **Canon Denshi Kabushiki Kaisha**,
Chichibu-shi, Saitama (JP)

(72) Inventors: **Takahito Yoshizawa**, Kawaguchi (JP);
Mitsuo Shibata, Matsudo (JP)

(73) Assignee: **Canon Denshi Kabushiki Kaisha**,
Chichibu-shi (JP)

(**) Term: **15 Years**

(21) Appl. No.: **29/579,185**

(22) Filed: **Sep. 28, 2016**

(30) **Foreign Application Priority Data**

Mar. 31, 2016 (JP) 2016-007258
Mar. 31, 2016 (JP) 2016-007259

(51) **LOC (11) Cl.** **16-05**

(52) **U.S. Cl.**
USPC **D16/219**

(58) **Field of Classification Search**
USPC D16/200–220, 239, 235, 242, 250, 310,
D16/136; D14/251, 138 C, 302, 129,
(Continued)

(56) **References Cited**

U.S. PATENT DOCUMENTS

1,214,250 A * 1/1917 Wollensack G03B 9/22
396/476
1,547,658 A * 7/1925 Kunze G03B 9/08
396/510

(Continued)

OTHER PUBLICATIONS

Canon 50mm, announced Sep. 8, 2014 [online], site visited Nov. 9, 2017], Available from Internet URL: <https://www.youtube.com/watch?v=r3-_aZztQzY> at approximately 2:43.*

(Continued)

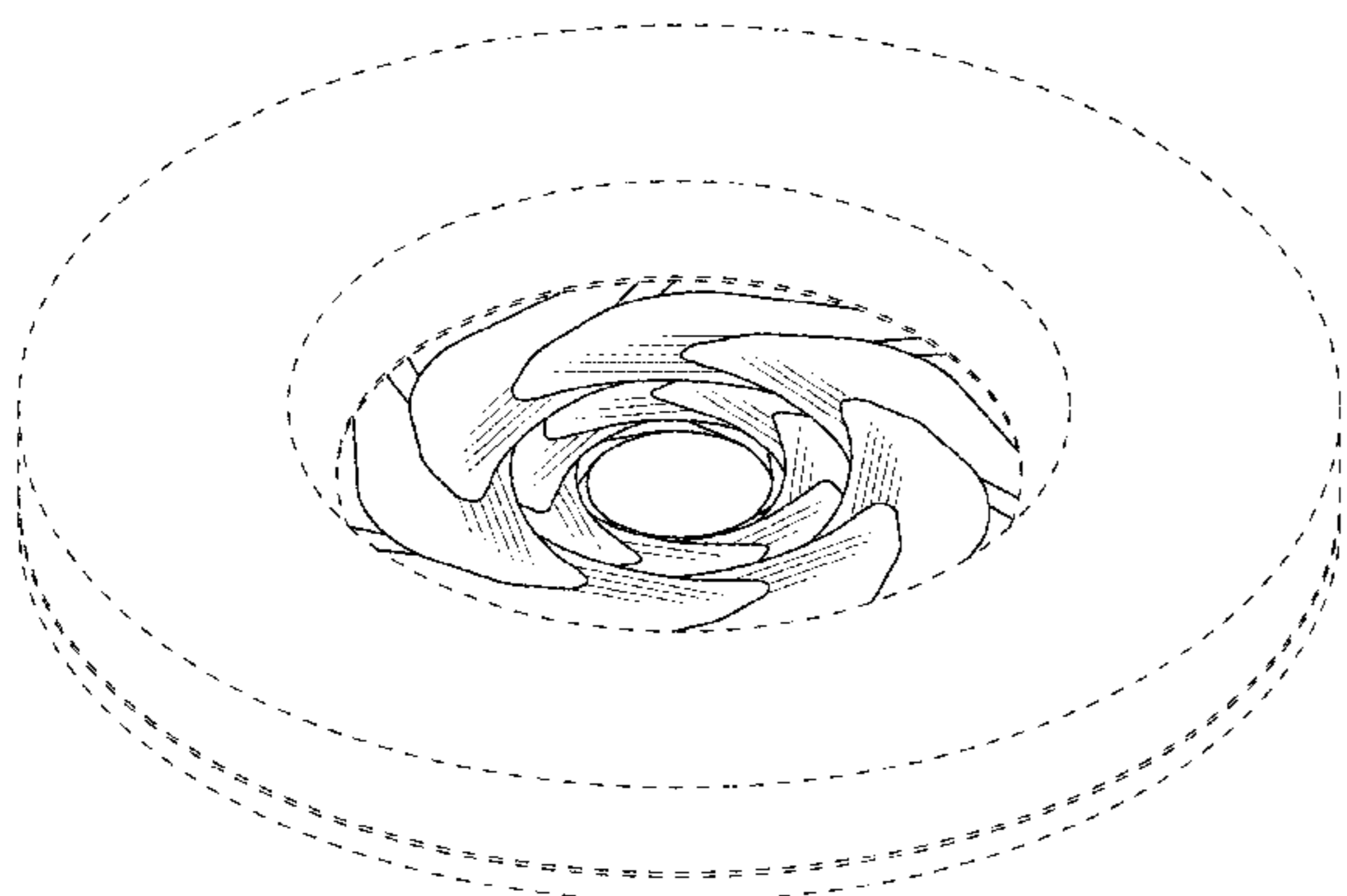

Primary Examiner — Barbara Fox

Assistant Examiner — Mary C Ramirez

(74) *Attorney, Agent, or Firm* — Fitzpatrick, Cella,
Harper & Scinto

(57) **CLAIM**

The ornamental design for an interchangeable lens for camera, as shown and described.

DESCRIPTION

FIG. 1 is a perspective view of the first embodiment of an interchangeable lens for camera shown from the front side, wherein the diaphragm adjuster has plural blade groups each having seven diaphragm blades;

FIG. 2 is a front view of the first embodiment;

FIG. 3 is a rear view of the first embodiment;

FIG. 4 is a plan view of the first embodiment;

FIG. 5 is a right side view of the first embodiment;

FIG. 6 is a cross-sectional view of the first embodiment taken generally along line 6-6 in FIG. 2 with an internal mechanism omitted;

FIG. 7 is a front view of the first embodiment, wherein the diaphragm adjuster is in an open state;

FIG. 8 is a front view of the first embodiment, wherein a first blade group of the diaphragm adjuster is in a transition state;

FIG. 9 is a front view of the first embodiment, wherein a second blade group the diaphragm adjuster is in a transition state;

FIG. 10 is a front view of the first embodiment, wherein a third blade group of the diaphragm adjuster is in a transition state;

FIG. 11 is an enlarged perspective view of the diaphragm adjuster of the first embodiment shown from the front side;

FIG. 12 is a disassembled perspective view of the diaphragm adjuster of the first embodiment shown from the front side;

FIG. 13 is a perspective view of the second embodiment of an interchangeable lens for camera shown from the front side, wherein the diaphragm adjuster has plural blade groups each having nine diaphragm blades;

FIG. 14 is a front view of the second embodiment;

FIG. 15 is a rear view of the second embodiment;

(Continued)

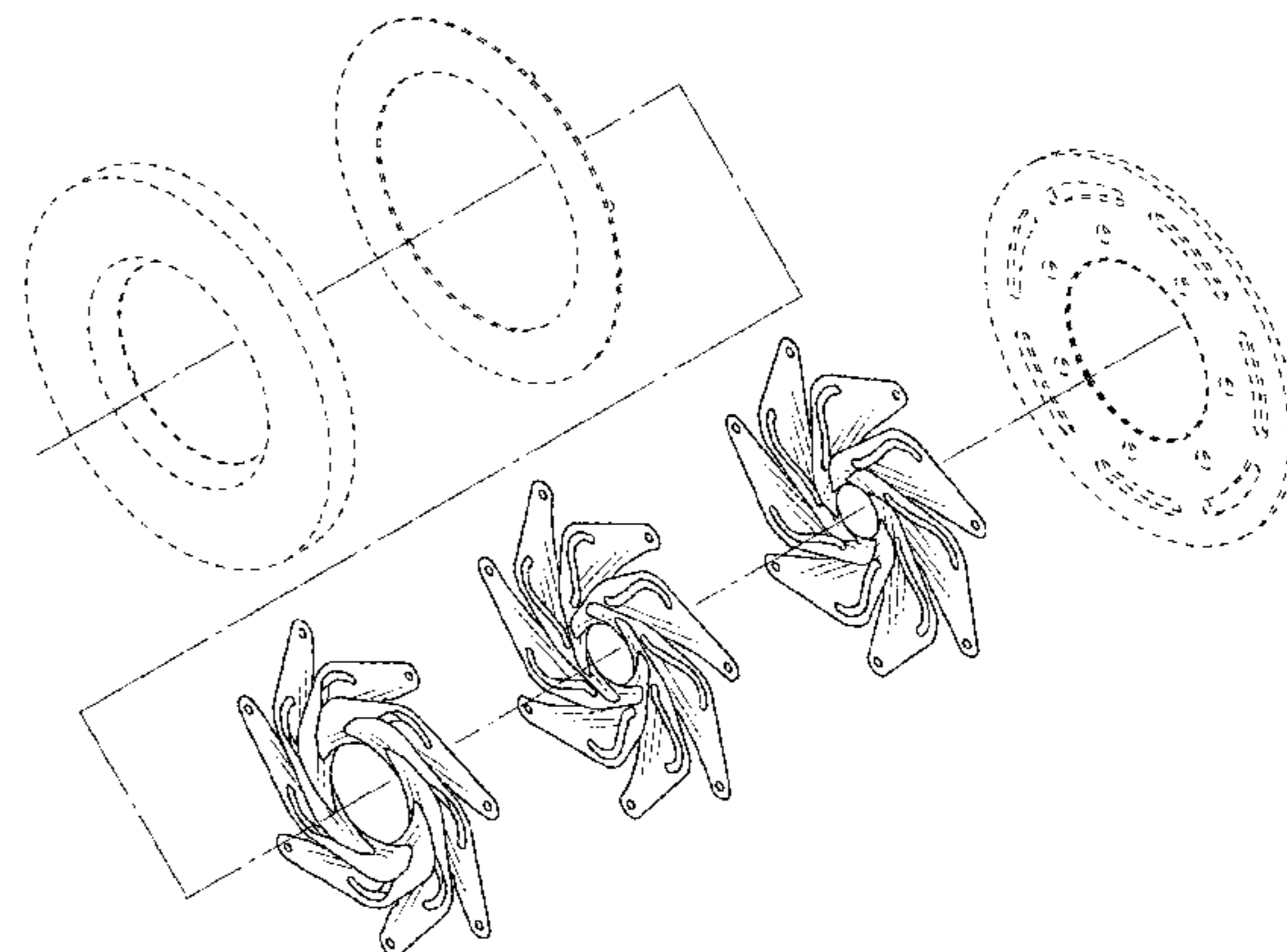

FIG. 16 is a plan view of the second embodiment;
 FIG. 17 is a right side view of the second embodiment;
 FIG. 18 is a cross-sectional view of the second embodiment taken generally along line 18-18 in FIG. 14 with an internal mechanism omitted;
 FIG. 19 is a front view of the second embodiment, wherein the diaphragm adjuster is in an open state;
 FIG. 20 is a front view of the second embodiment, wherein a first blade group of the diaphragm adjuster is in a transition state;
 FIG. 21 is a front view of the second embodiment, wherein a second blade group the diaphragm adjuster is in a transition state;
 FIG. 22 is a front view of the second embodiment, wherein a third blade group of the diaphragm adjuster is in a transition state;
 FIG. 23 is an enlarged perspective view of the diaphragm adjuster of the second embodiment shown from the front side; and,
 FIG. 24 is a disassembled perspective view of the diaphragm adjuster of the second embodiment shown from the front side.

The broken lines shown in the drawings depict portions of the interchangeable lens for camera and form no part of the claimed design.

1 Claim, 22 Drawing Sheets

(58) **Field of Classification Search**

USPC D14/130, 496; D26/28, 36, 37, 46, 39;
 D29/104; D10/104.1, 50, 65, 74
 CPC ... G02B 7/02; G02B 7/04; G02B 7/14; G03B
 17/00; G03B 17/14; G03B 9/08; H04N
 5/2252; H04N 5/2253; H04N 5/2254;
 H04N 7/00; F16M 13/00

See application file for complete search history.

(56) **References Cited**

U.S. PATENT DOCUMENTS

4,408,859 A * 10/1983 Fukahori G03B 9/08
 396/246
 D315,743 S * 3/1991 Martin D16/219
 5,748,382 A * 5/1998 Maguire, Jr. G02B 27/2228
 348/E13.014
 D715,810 S * 10/2014 Tsukamoto D14/485

D756,440 S * 5/2016 Yoshizawa D16/219
 9,658,515 B2 * 5/2017 Nakano G03B 9/06
 9,674,467 B2 * 6/2017 Izawa H04N 5/3572
 D792,497 S * 7/2017 Oliveira D16/208
 9,715,104 B2 * 7/2017 Koze G02B 26/02
 D800,203 S * 10/2017 Yoshizawa D16/219
 2004/0126106 A1 * 7/2004 Horiike G03B 9/08
 396/463
 2005/0238348 A1 * 10/2005 Oh G03B 9/06
 396/451
 2009/0097136 A1 * 4/2009 Otsu G03B 9/00
 359/739
 2014/0185153 A1 * 7/2014 Shibasaki G02B 7/10
 359/823
 2015/0015773 A1 * 1/2015 Tulyakov H04N 5/238
 348/362
 2015/0160533 A1 * 6/2015 Yoshizawa G03B 9/06
 396/510
 2015/0181090 A1 * 6/2015 Park H04N 5/2254
 348/374
 2015/0260947 A1 * 9/2015 Noguchi H04N 5/2254
 348/357
 2017/0102554 A1 * 4/2017 Yagi G02B 27/646
 2017/0313288 A1 * 11/2017 Tippy B60S 1/566

OTHER PUBLICATIONS

Aperture, announced 2016 [online], site visited Nov. 9, 2017], Available from Internet URL: <<http://oceanstudio.com/node/169>>.*
 Canon and the Death of the Diaphragm, announced Jul. 24, 2015, [online], site visited Nov. 9, 2017], Available from Internet URL: <<http://marcschultz.com/blog/canon-and-the-death-of-the-diaphragm/>>.*
 Using Aperture Creatively, announced Oct. 5, 2015 [online], site visited Nov. 9, 2017], Available from Internet URL: <<https://www.slideshare.net/MelaniePowell1/aperture-5353228>>.*
 How to Take Dynamic Landscape Photographs, announced Mar. 11, 2014 [online], site visited Nov. 9, 2017], Available from Internet URL: <<https://www.picturecorrect.com/tips/how-to-take-dynamic-landscape-photographs/>>.*
 Canon Ef-s 15-55mm, announced 2017 [online], site visited Nov. 9, 2017], Available from Internet URL: <<https://www.terapeak.com/worth/canon-ef-s-17-55mm-2-8-is-usm-power-diaphragm-aperture-iris-unit-a0922/361588264336/>>.*
 Zeiss Milvus, announced Sep. 10, 2015 [online], site visited Nov. 9, 2017], Available from Internet URL: <<http://lenspire.zeiss.com/en/zeiss-milvus-manual-focus-slr-lenses-for-ze-and-zf-2-mounts/>>.*
 AF Nikkor 50mm, announced May 1, 2017 [online], site visited Nov. 9, 2017], Available from Internet URL: <<https://www.youtube.com/watch?v=0cvNWu4k-Xc>>.*

* cited by examiner

Fig. 1

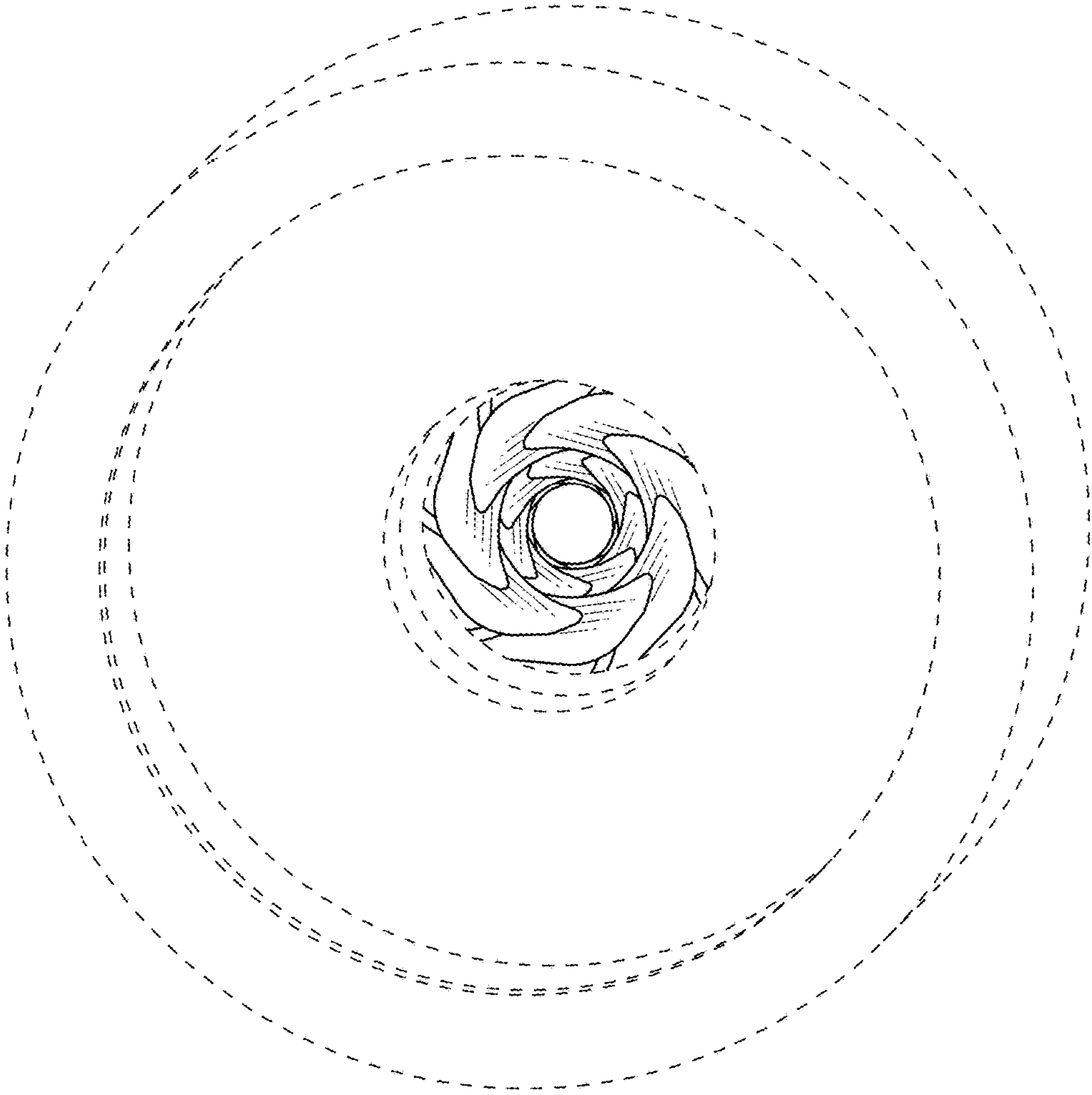

Fig. 2

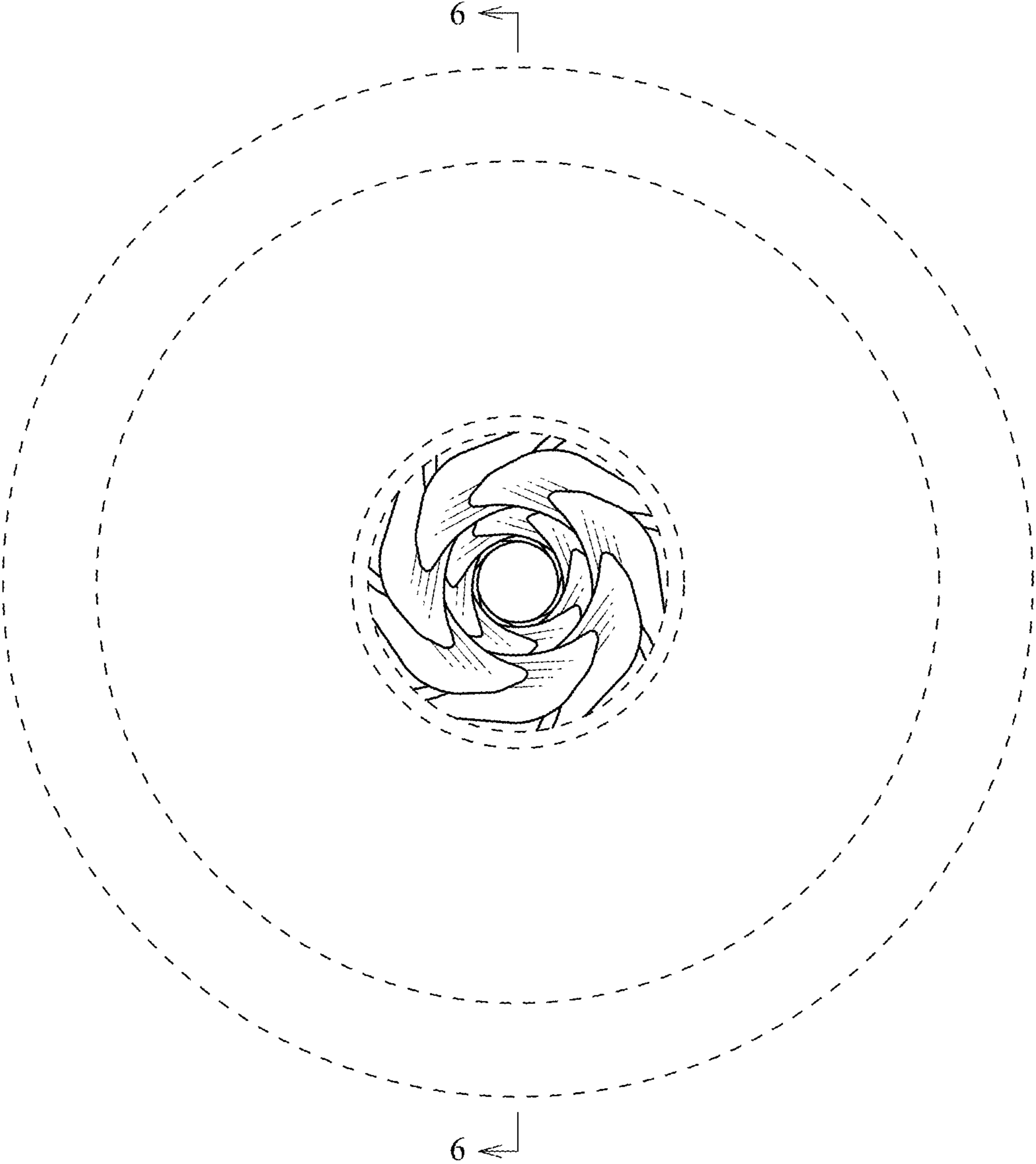

Fig. 3

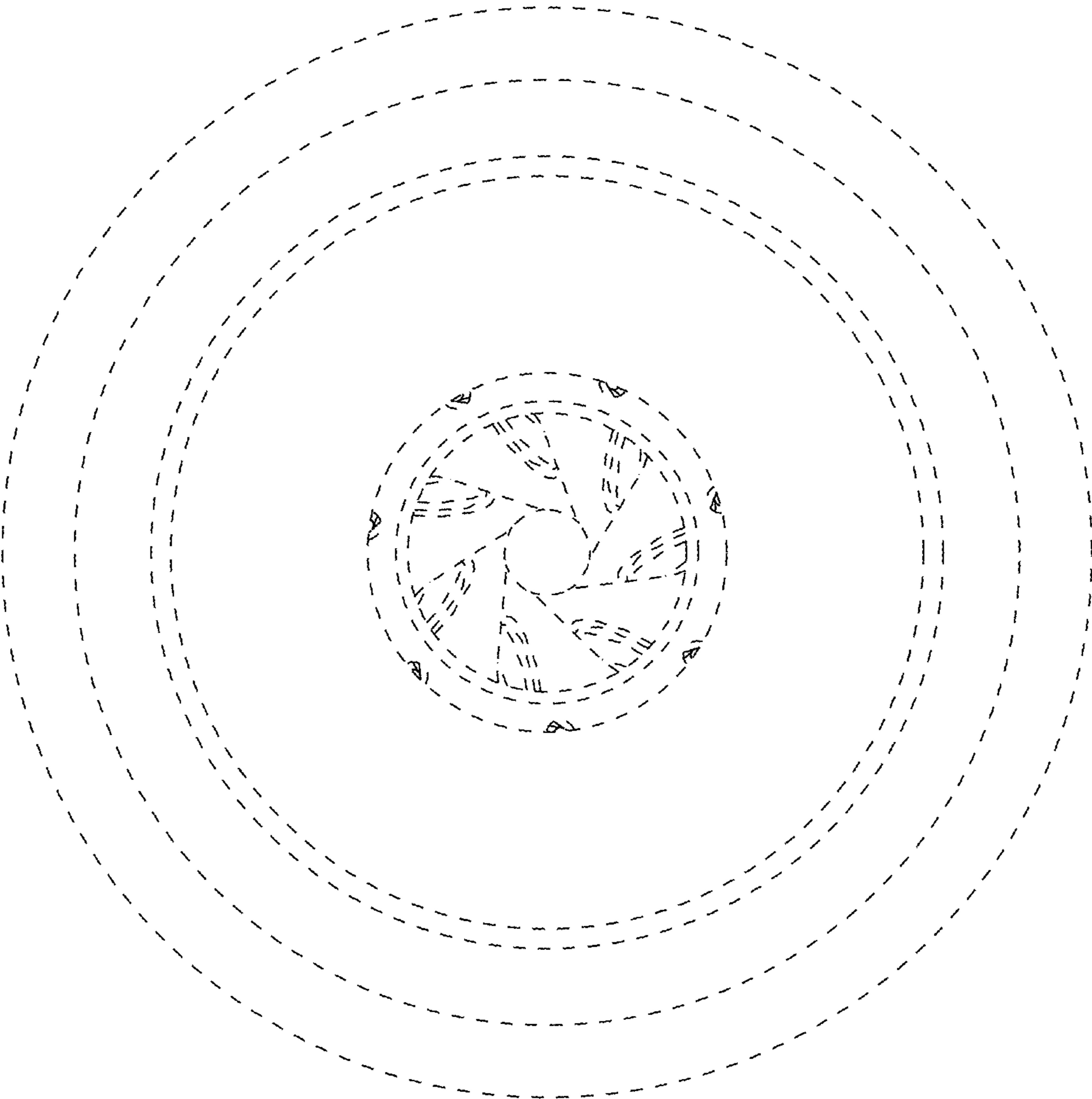

Fig. 4

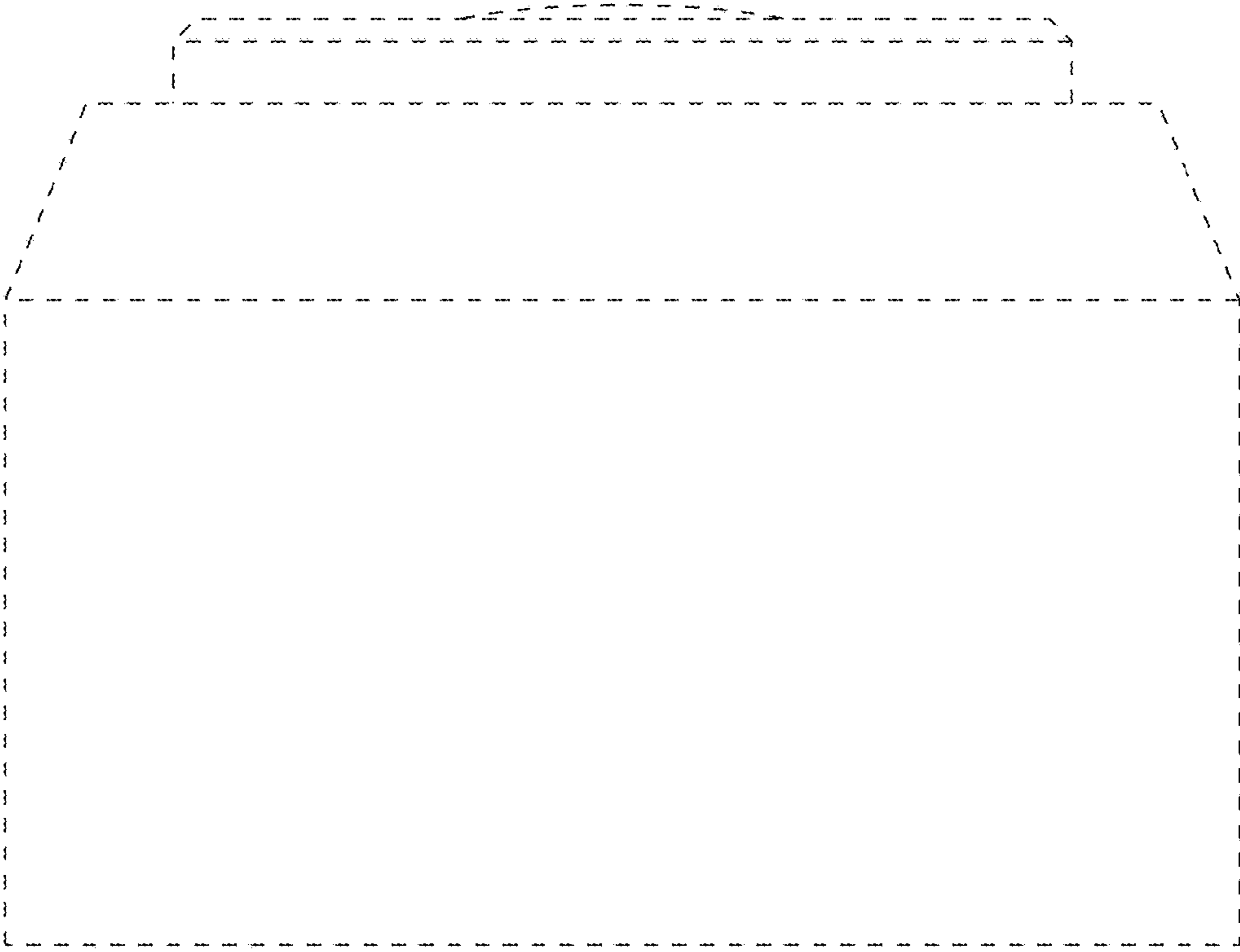

Fig. 5

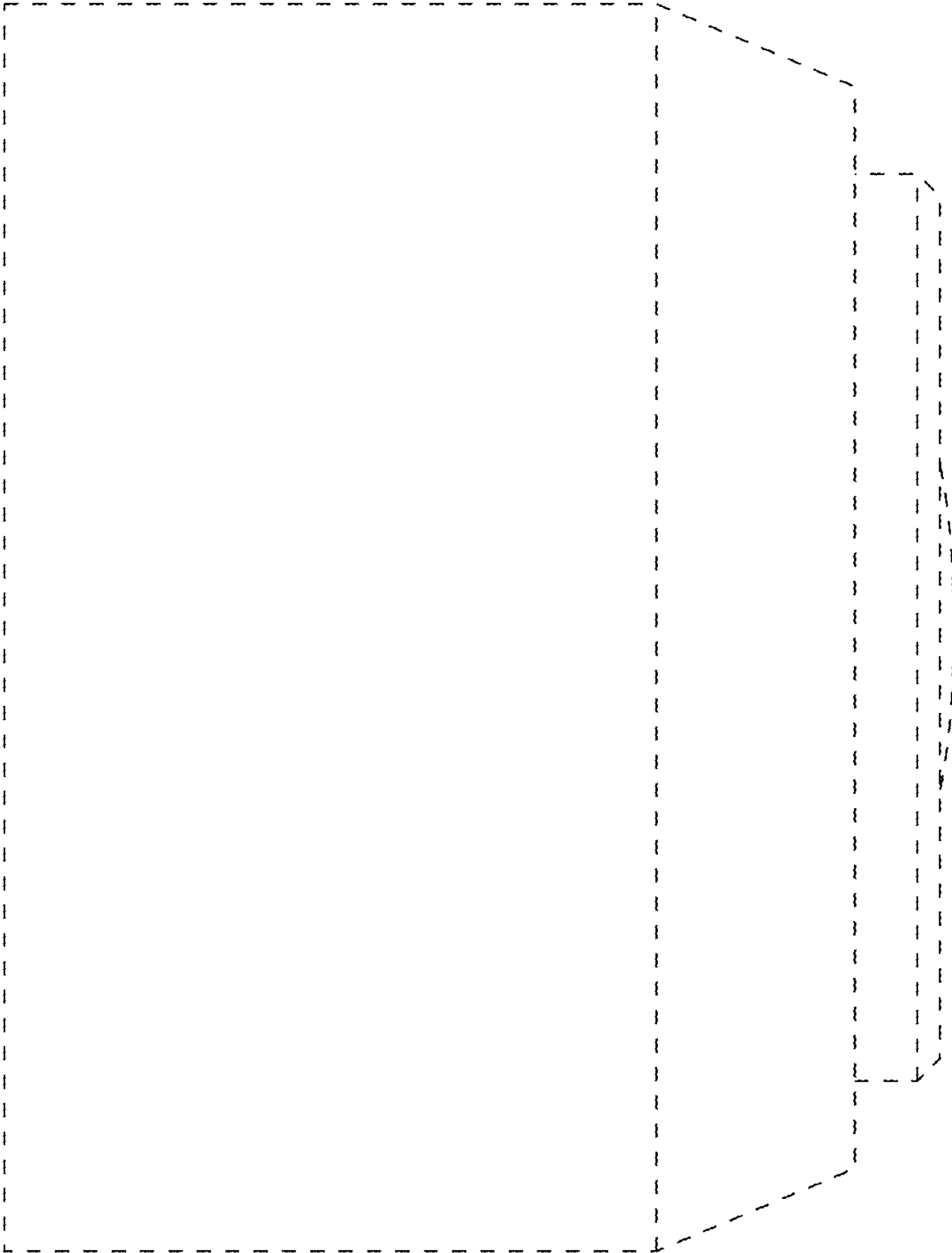

Fig. 6

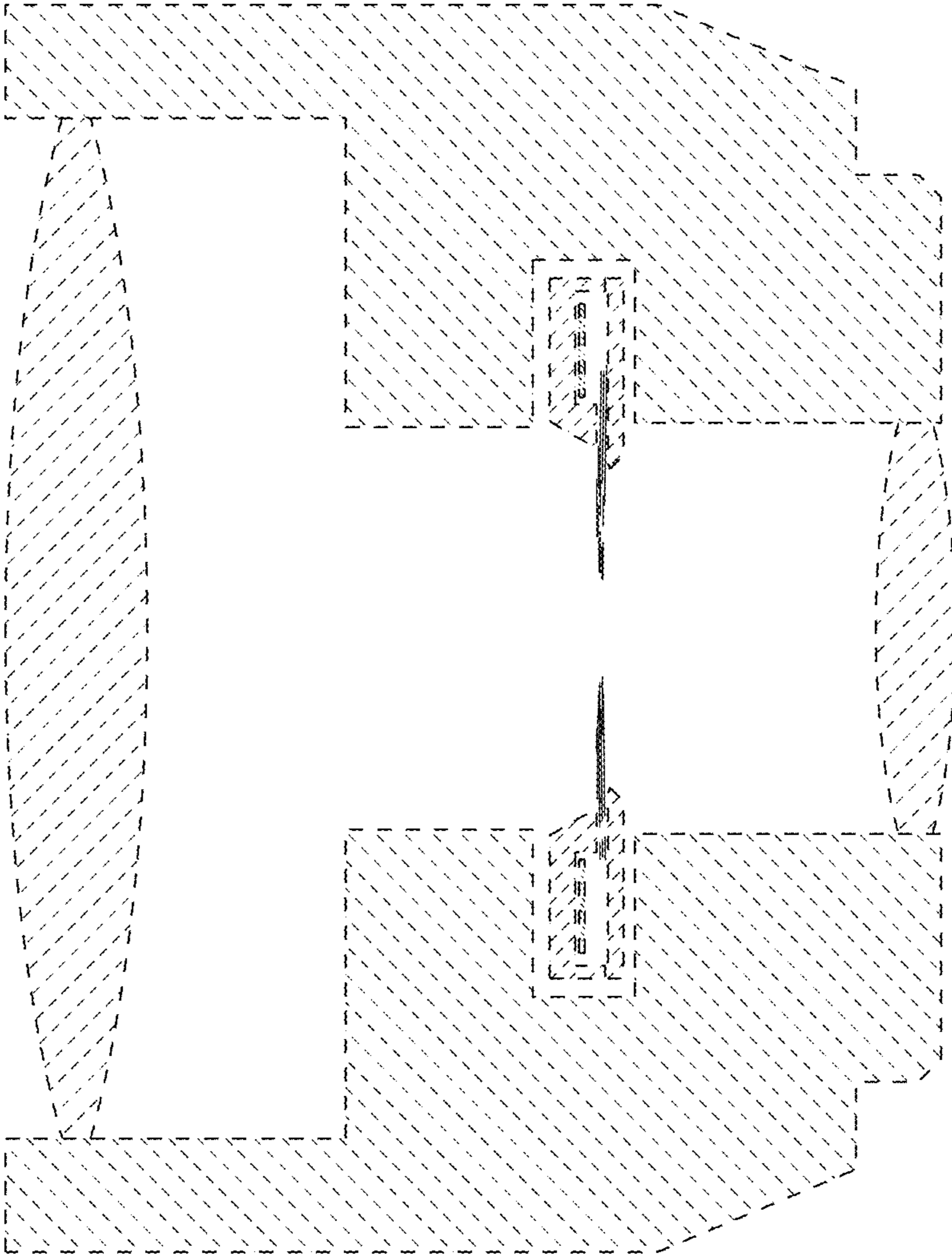

Fig. 7

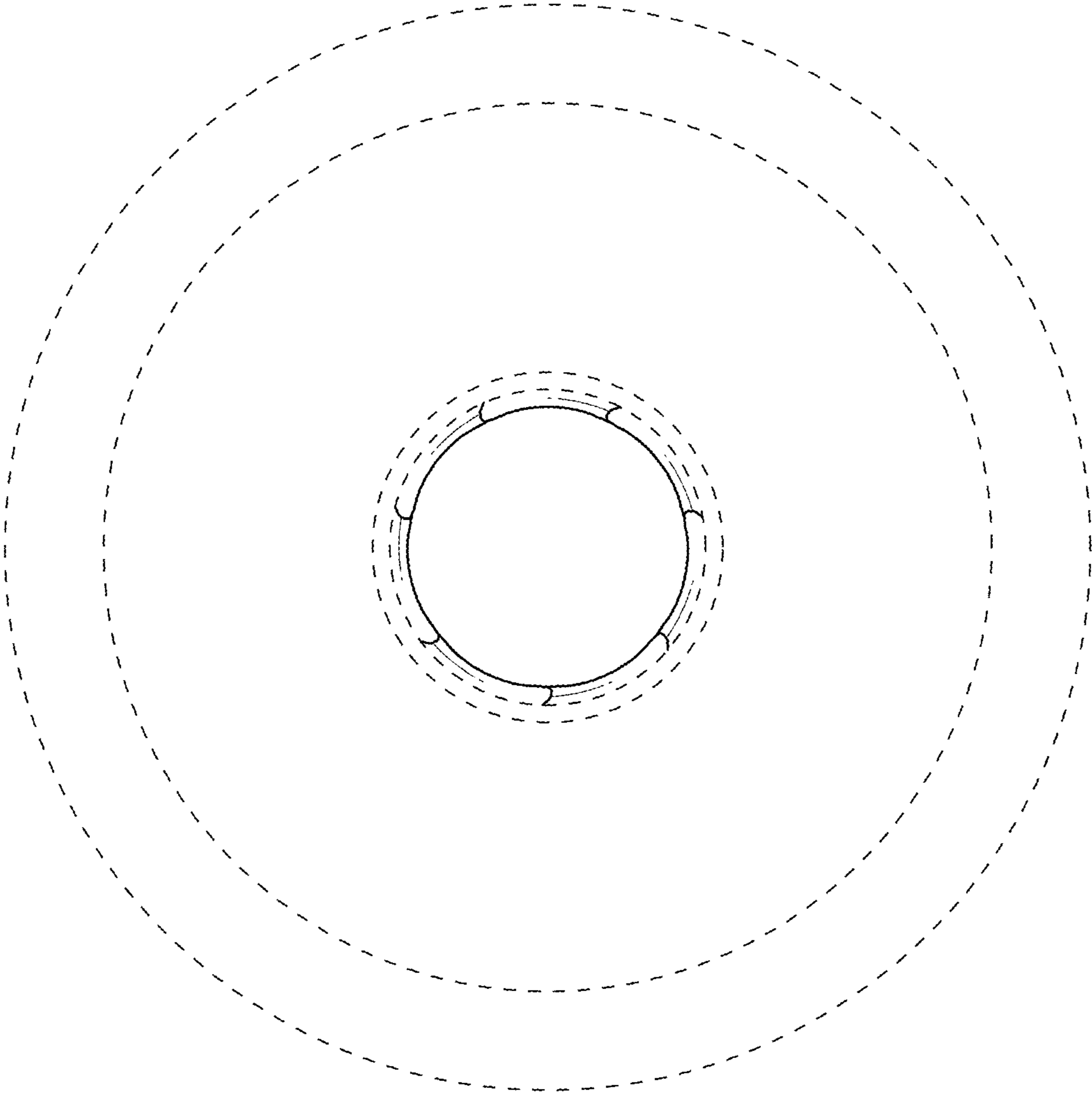

Fig. 8

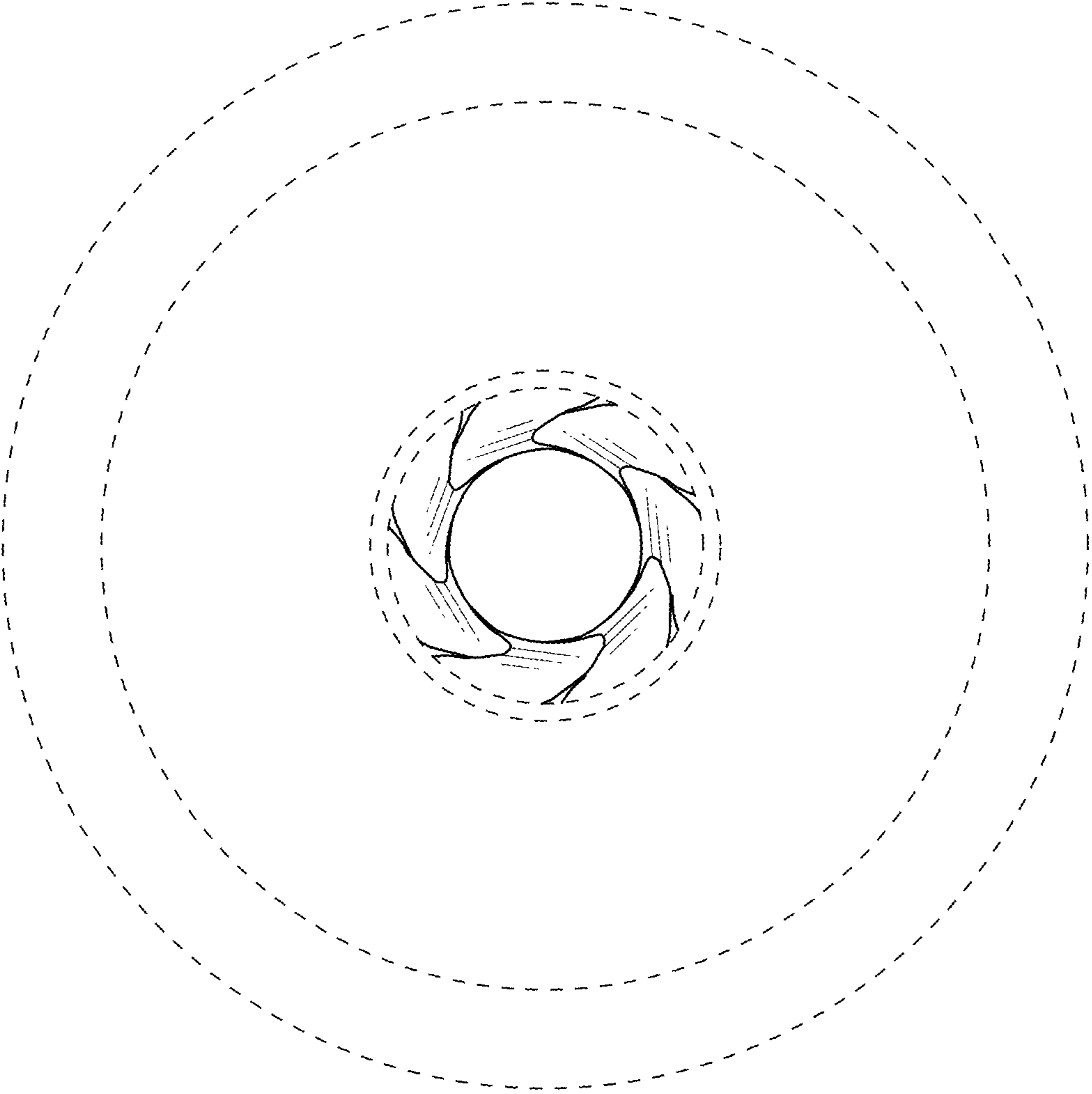

Fig. 9

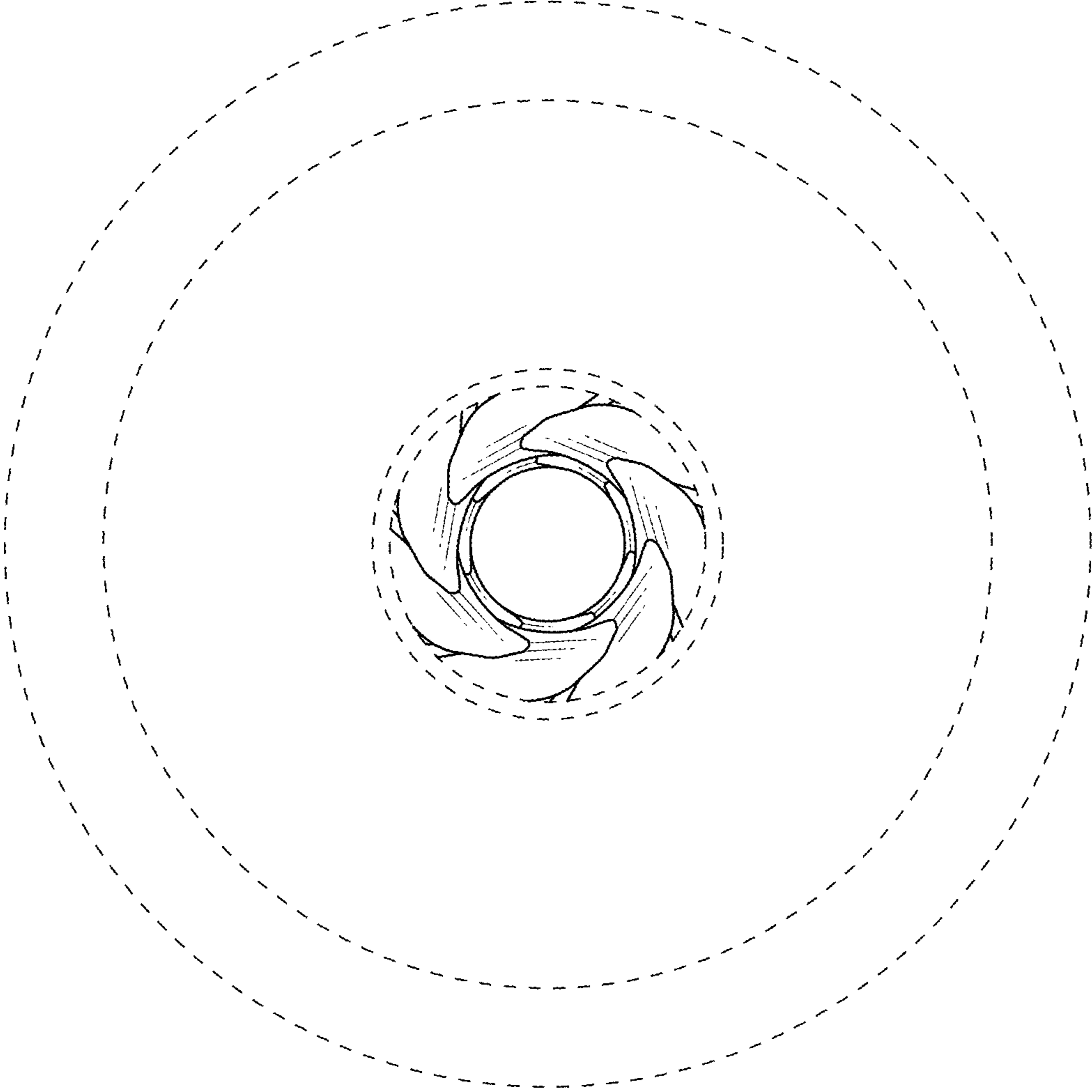

Fig. 10

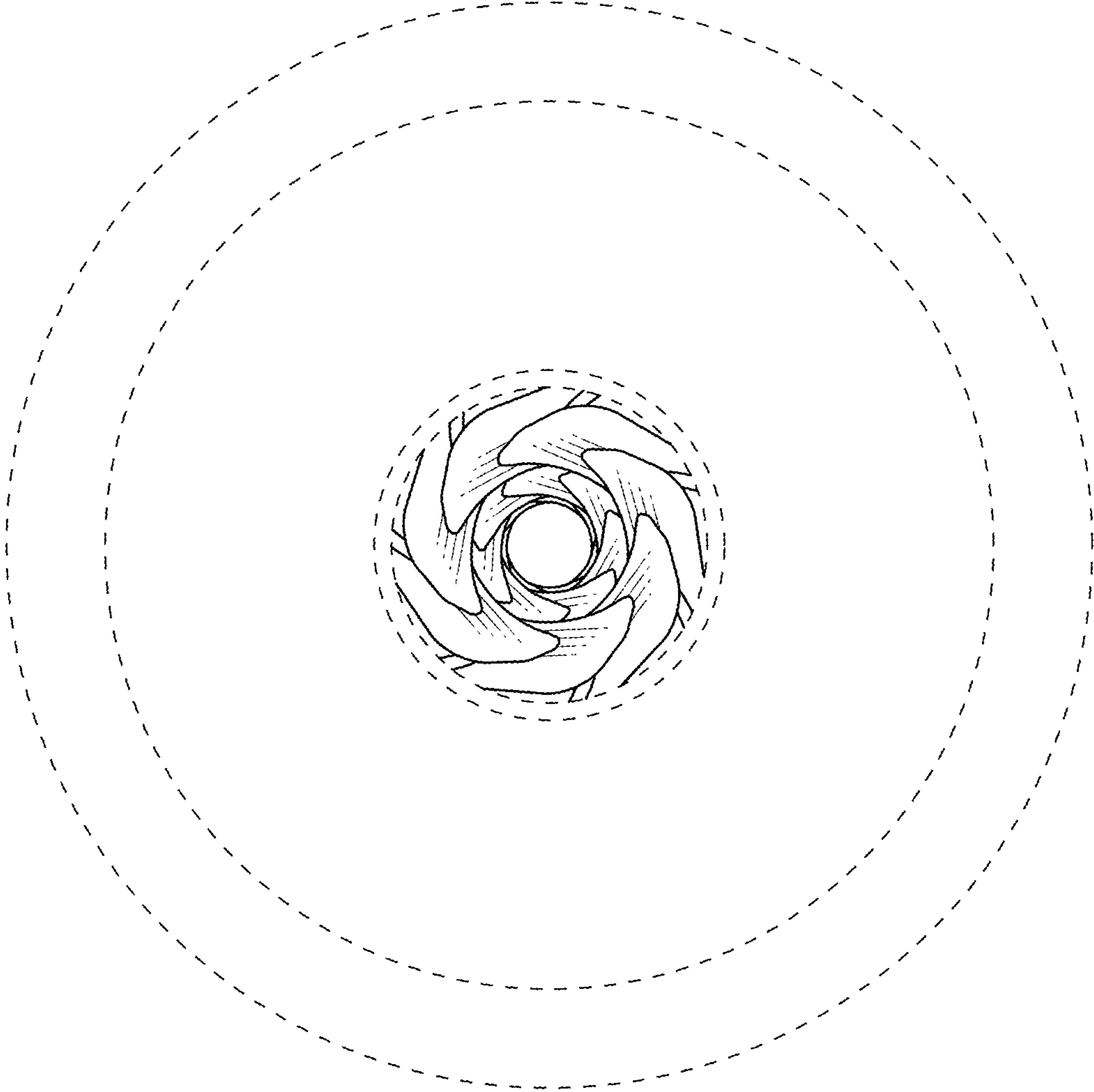

Fig. 11

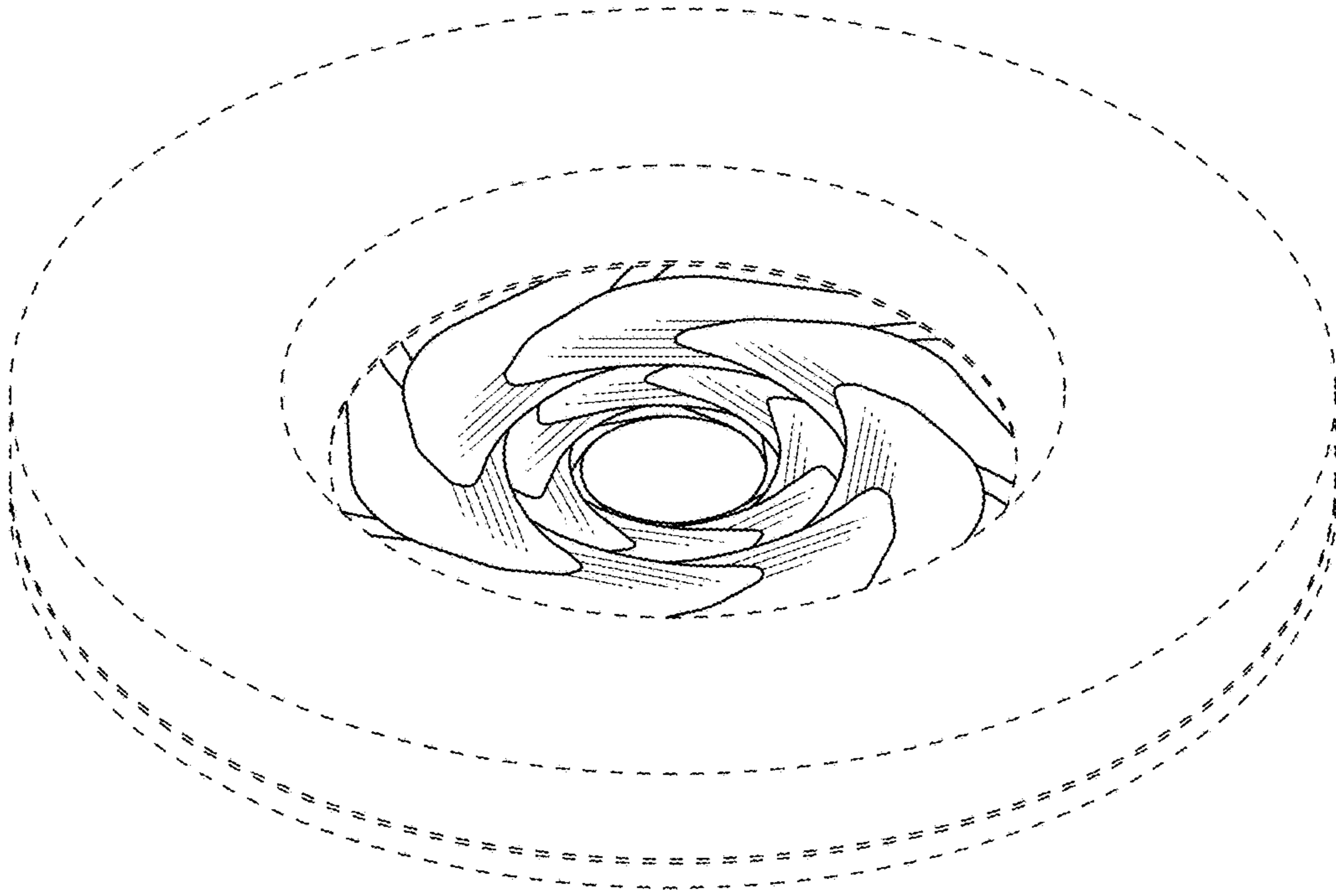

Fig. 12

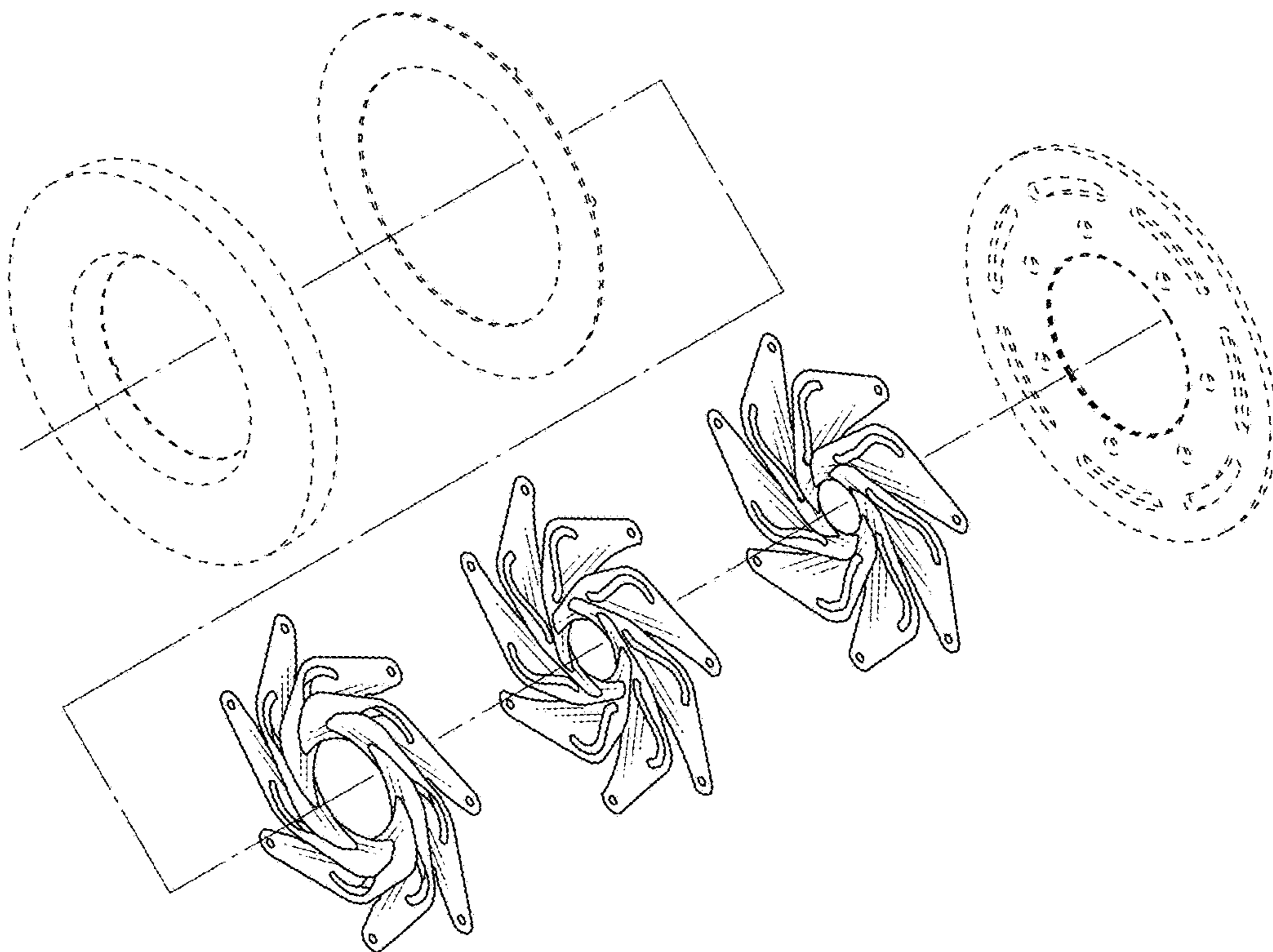

Fig. 13

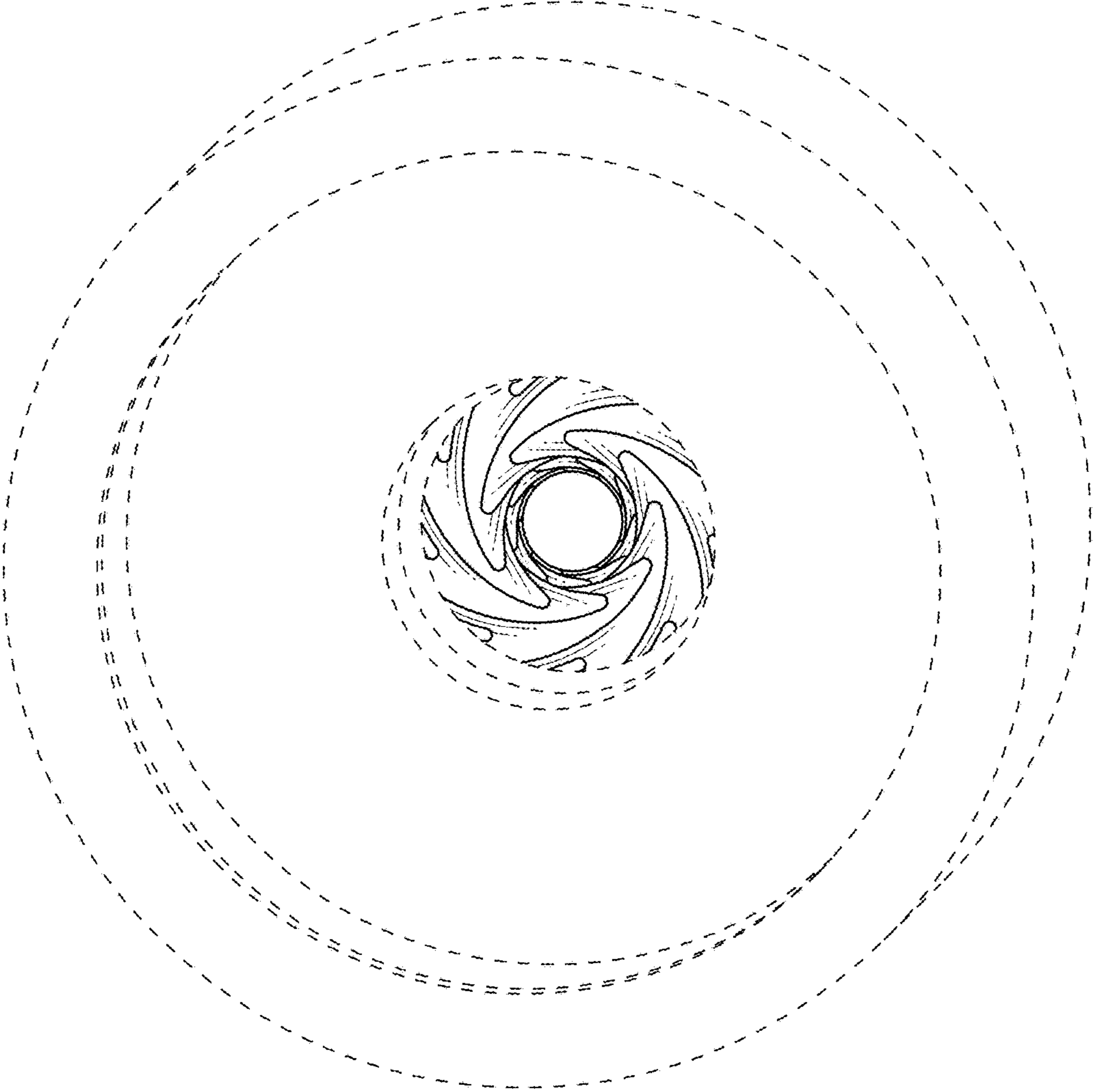

Fig. 14

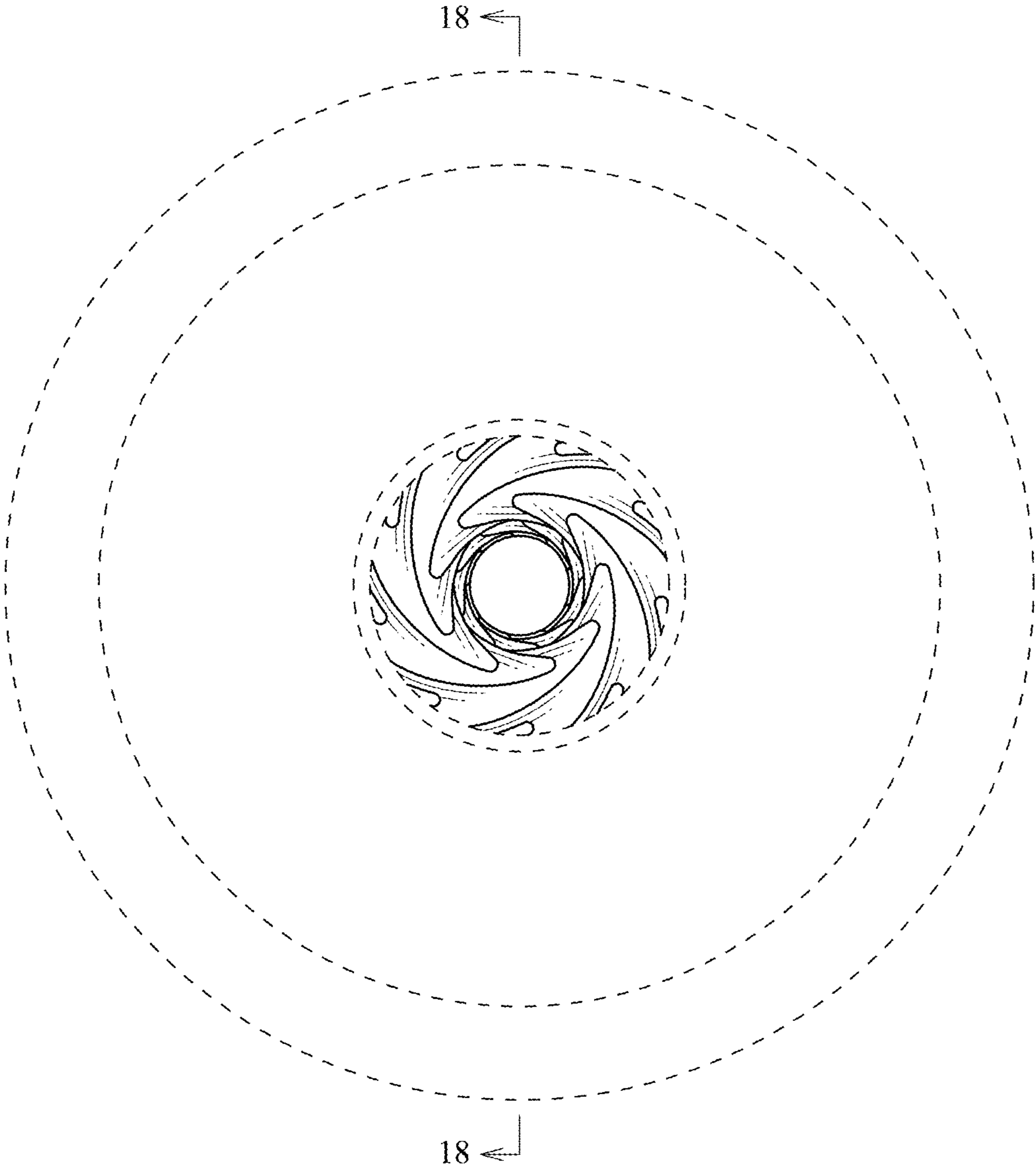

Fig. 15

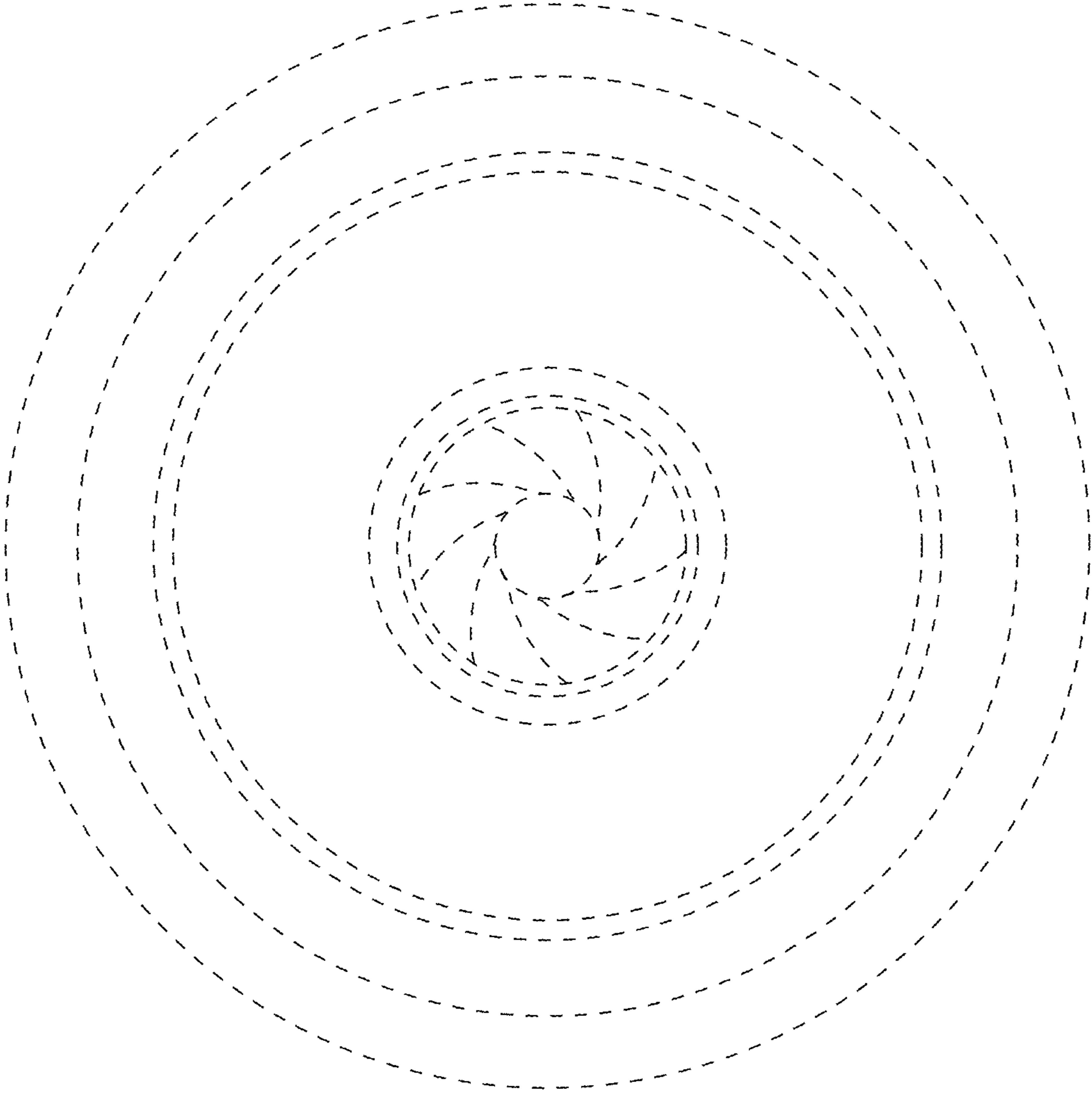

Fig. 16

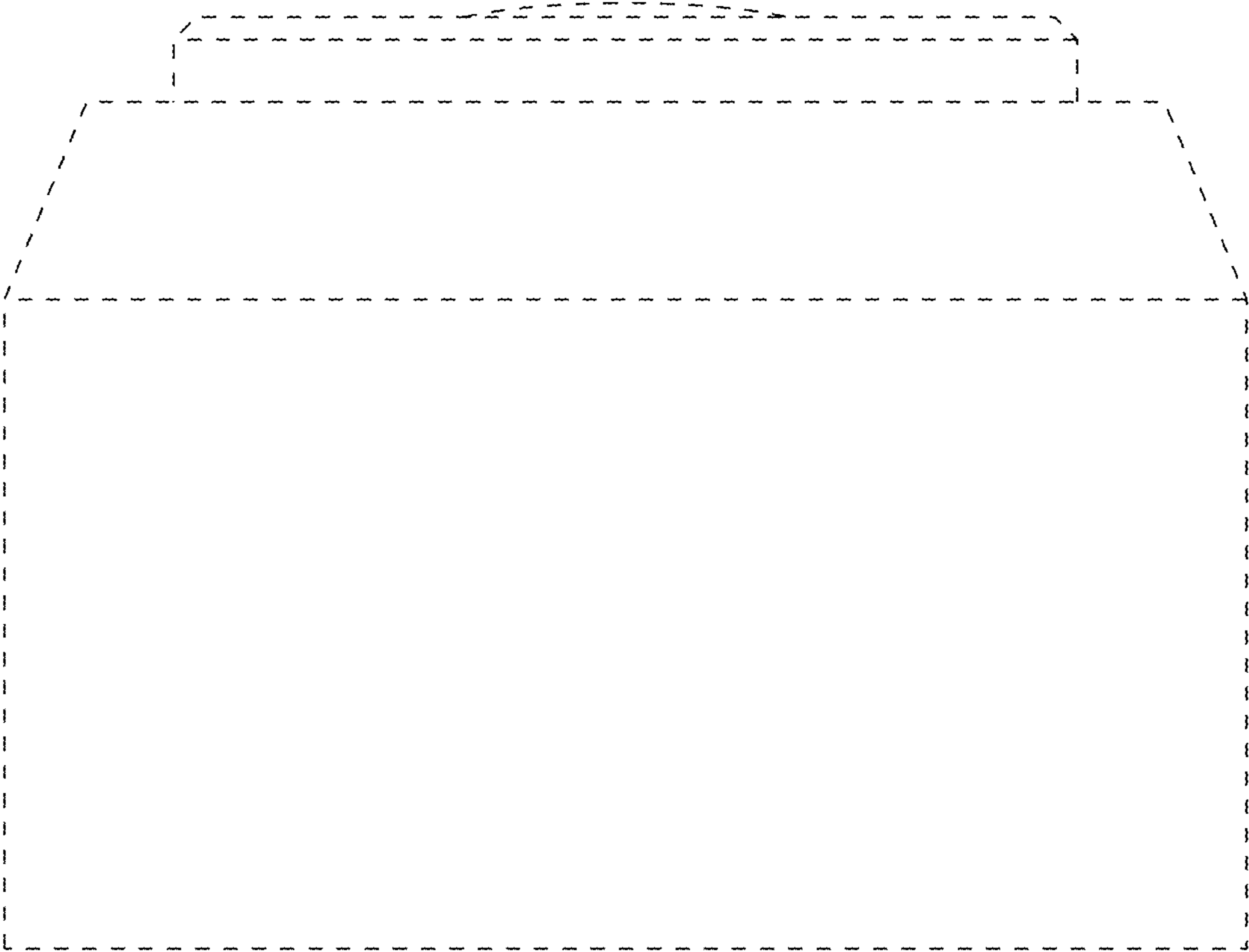

Fig. 17

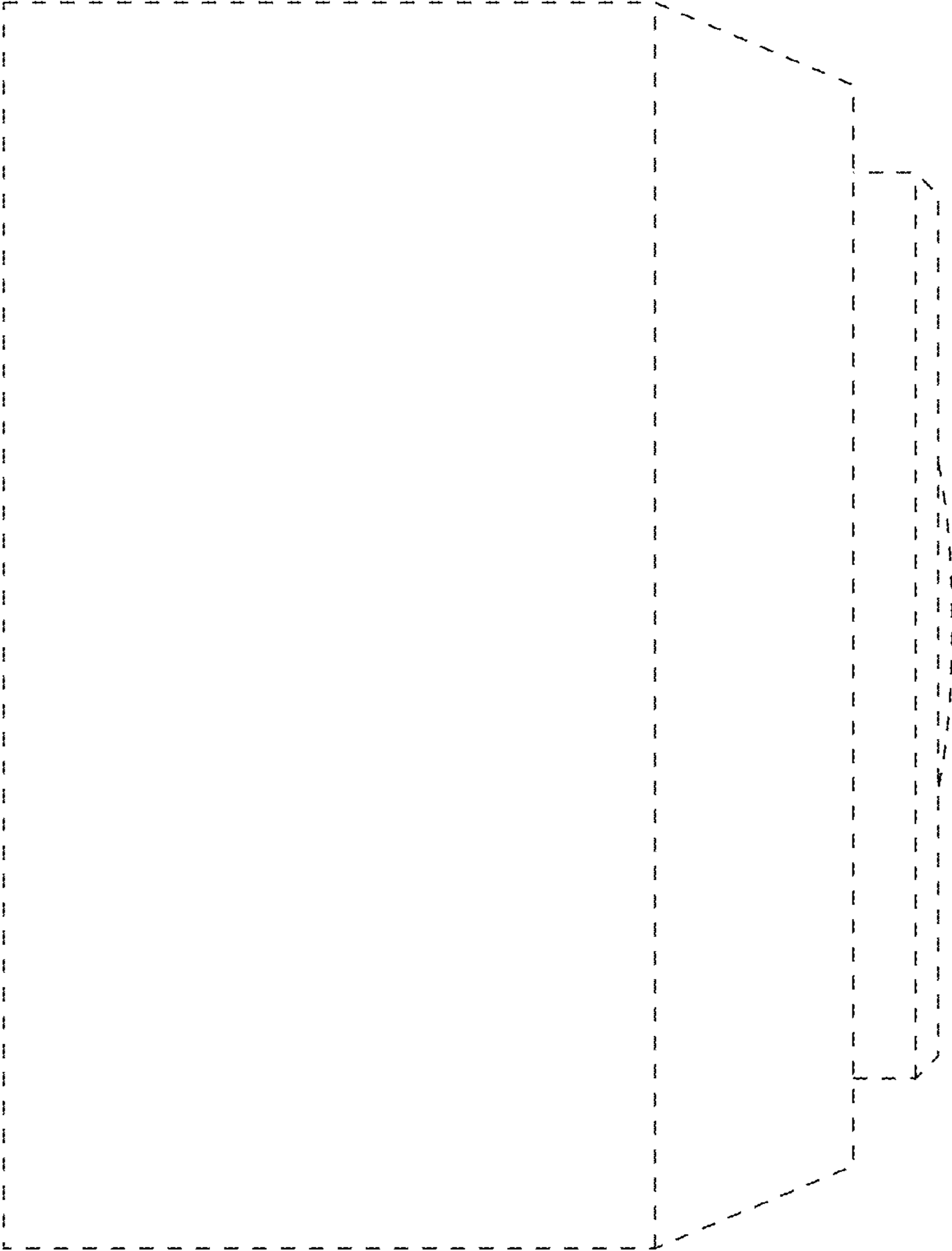

Fig. 18

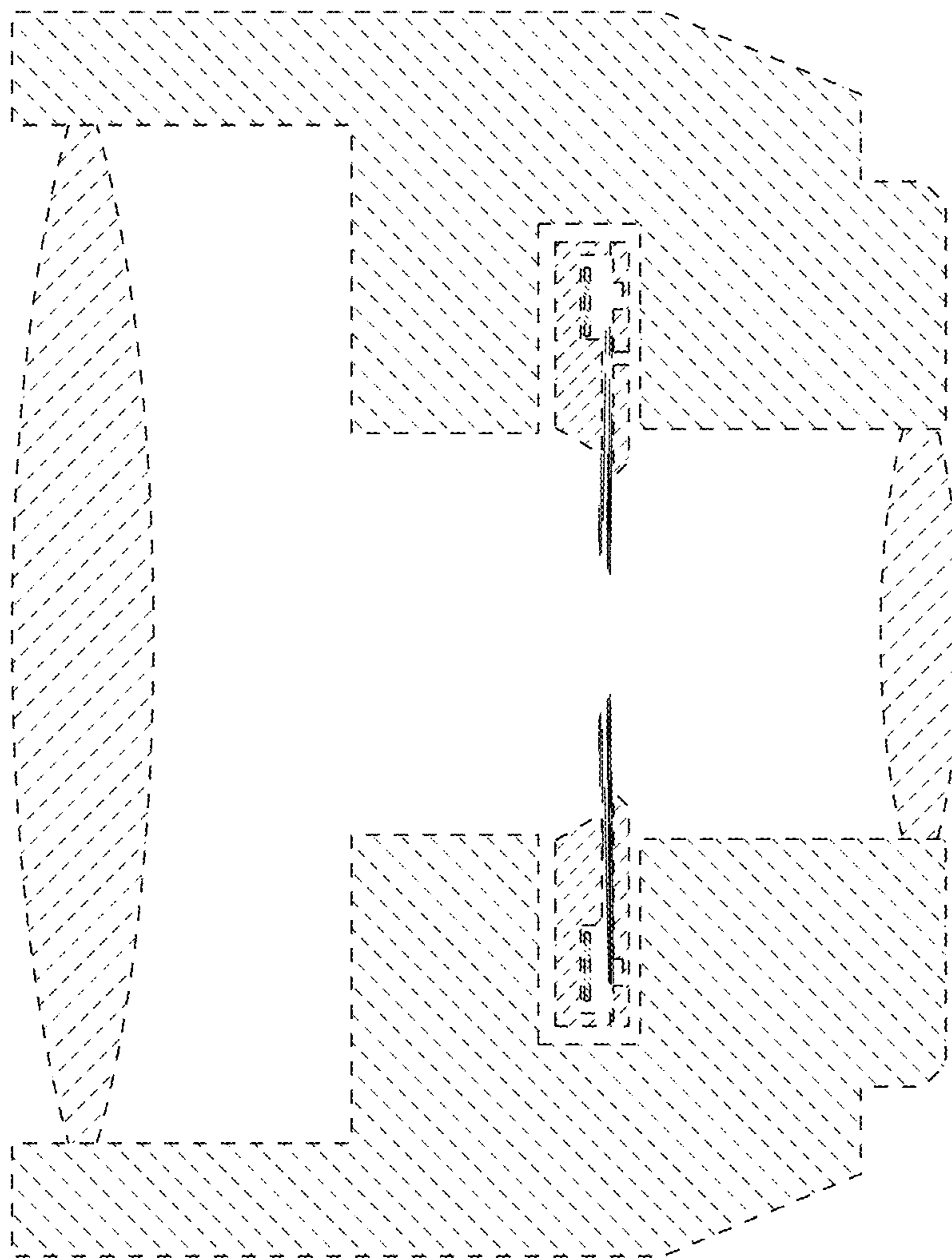

Fig. 19

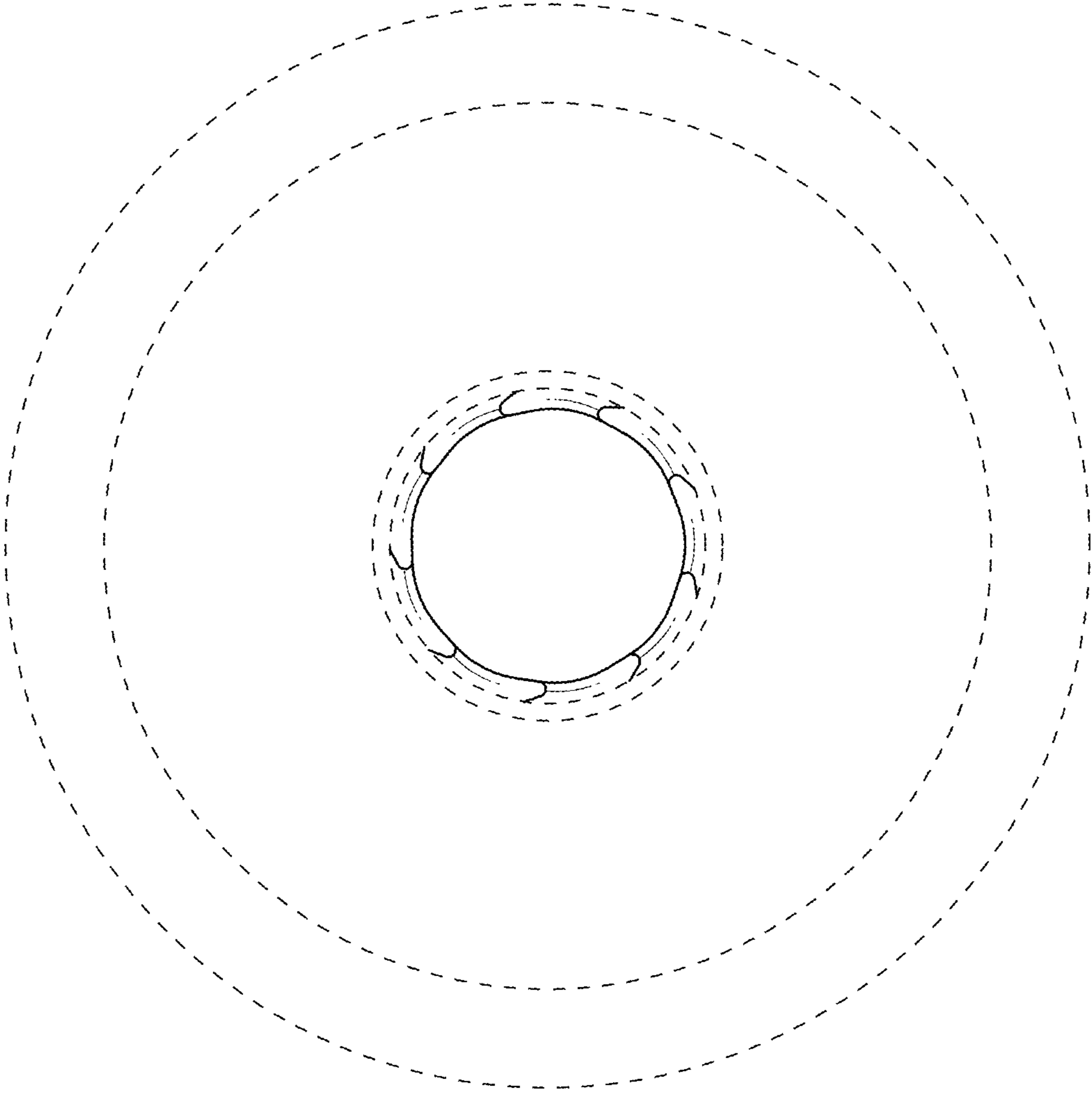

Fig. 20

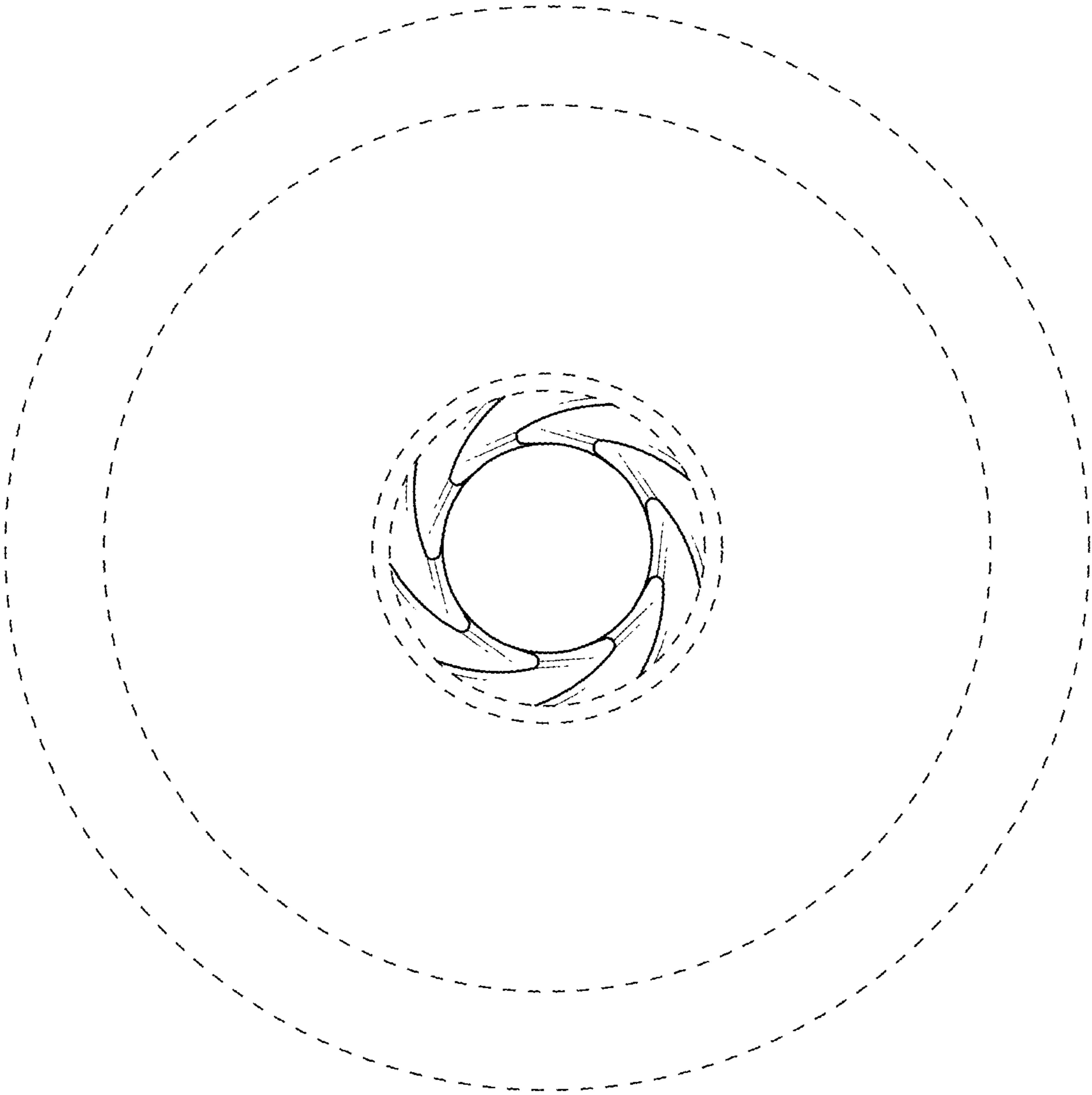

Fig. 21

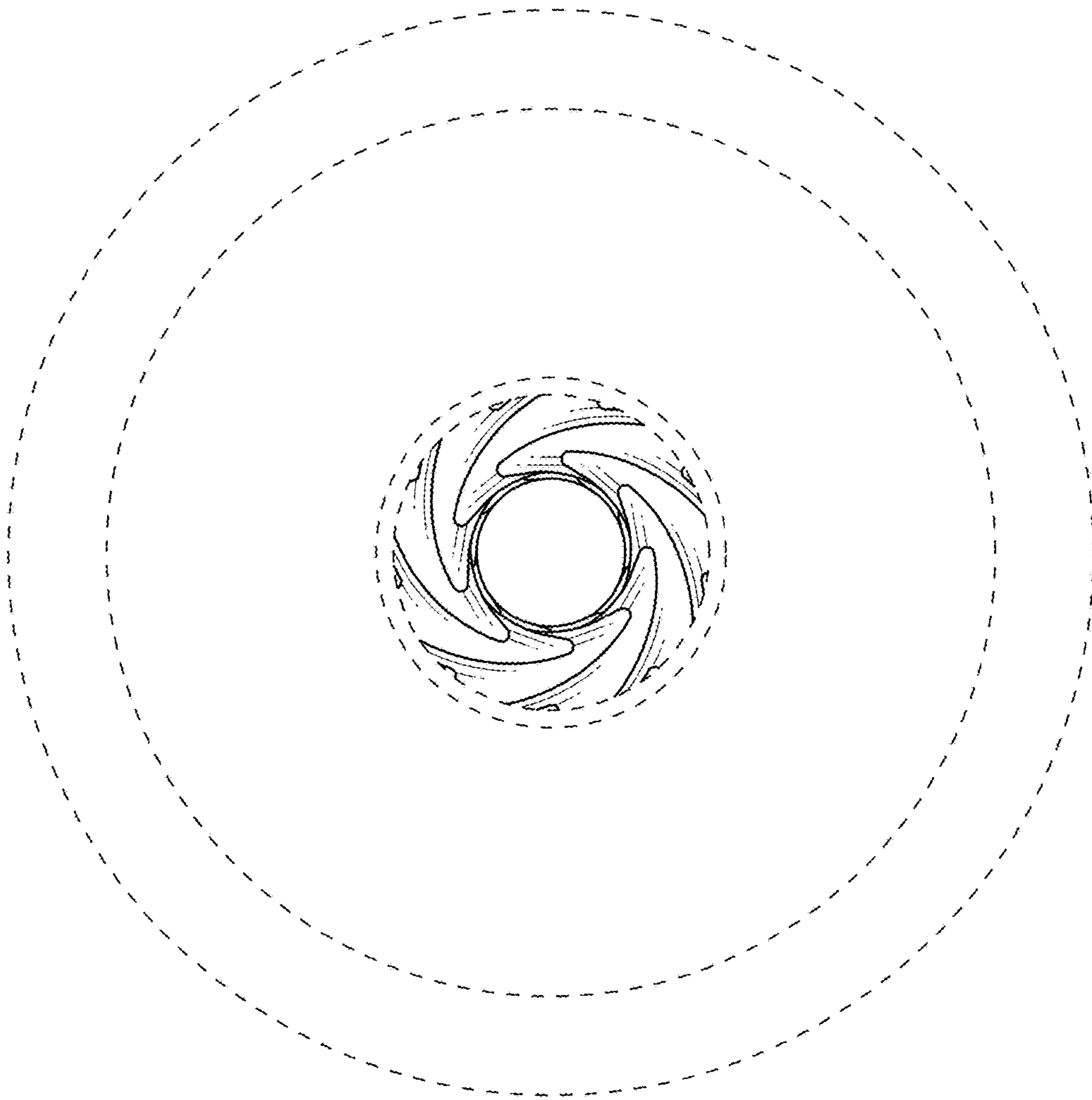

Fig. 22

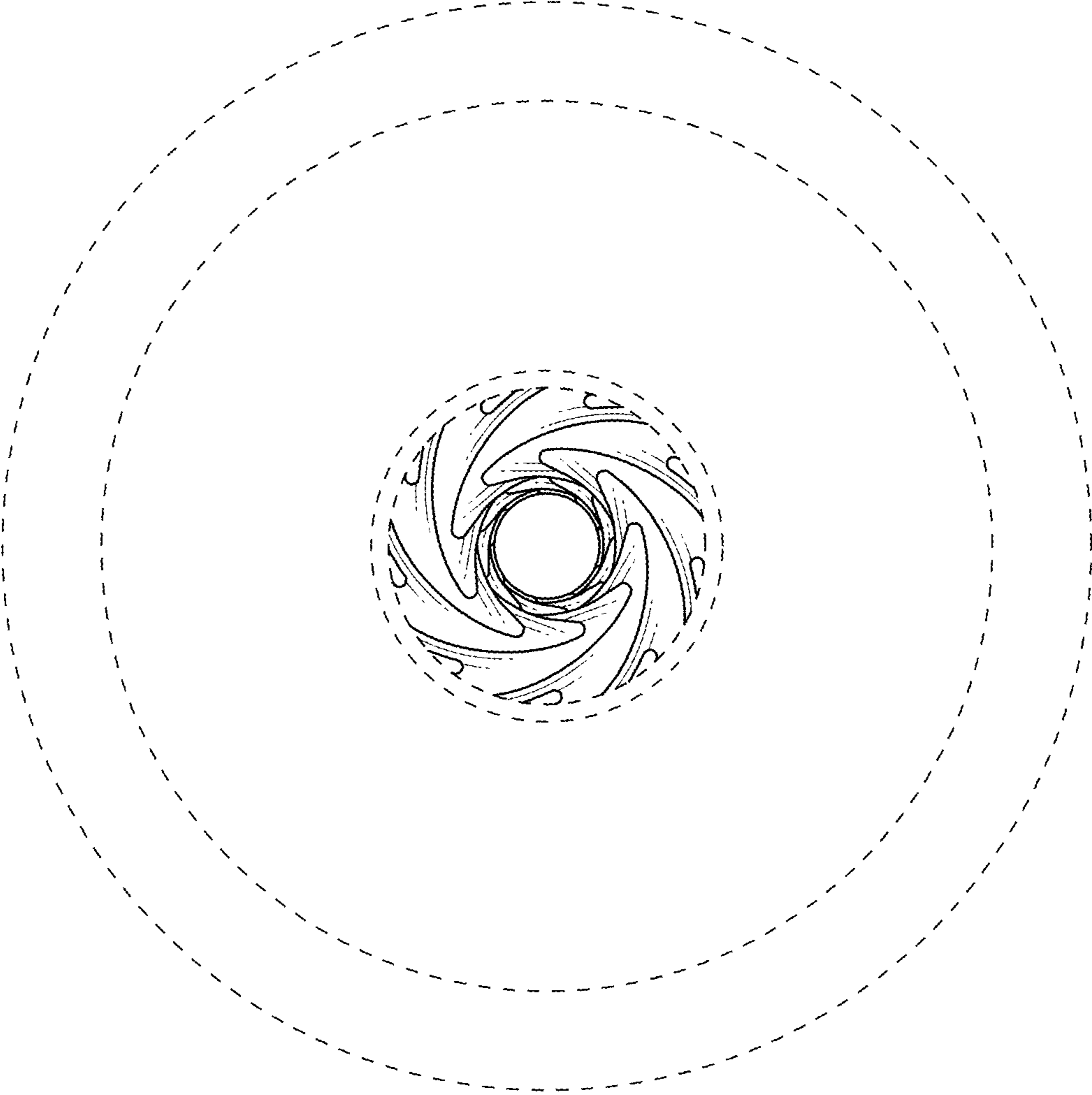

Fig. 23

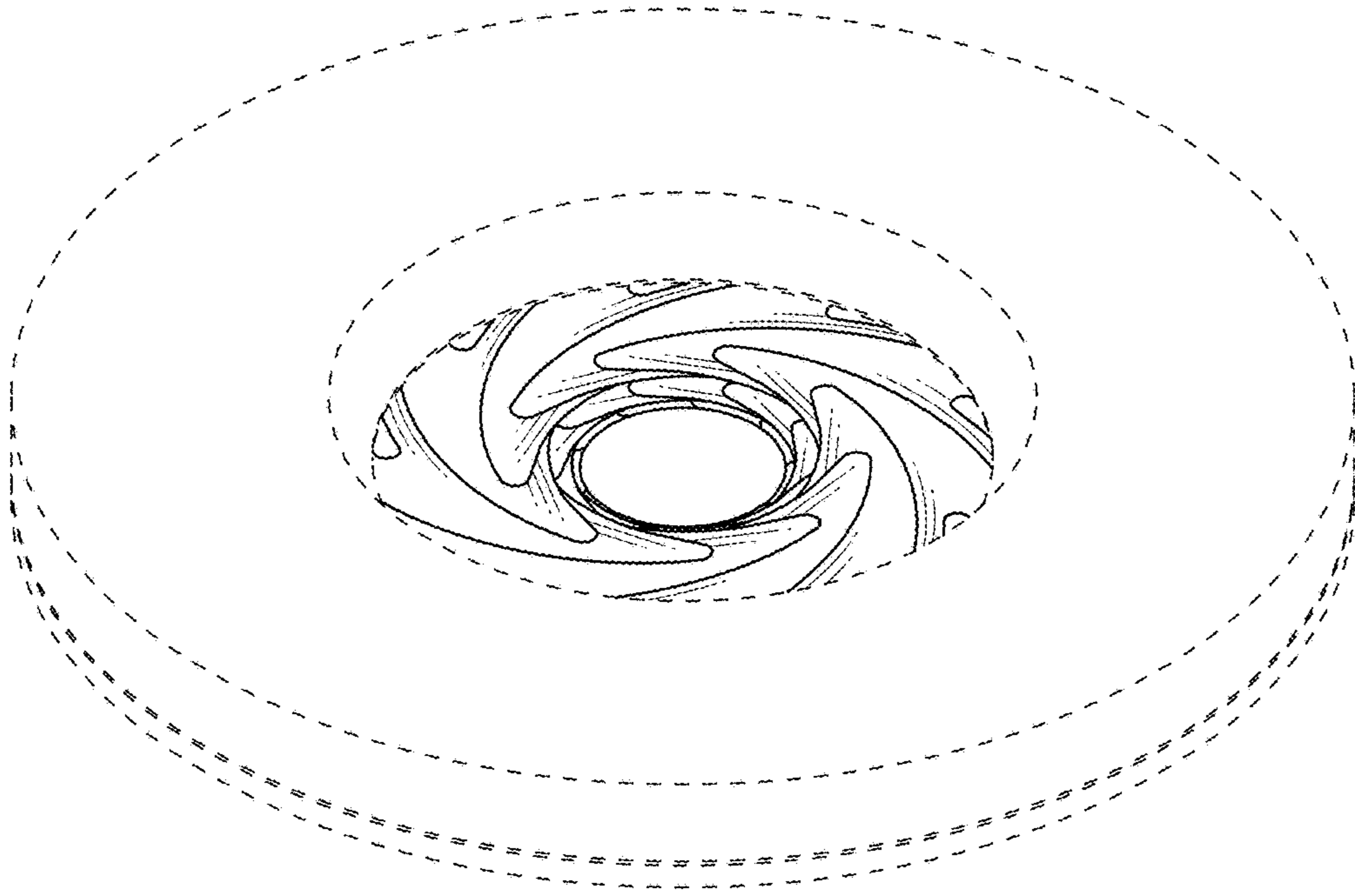

Fig. 24

