

US00D826173S

(12) **United States Design Patent** (10) **Patent No.:** **US D826,173 S**
Chen (45) **Date of Patent:** **** Aug. 21, 2018**

(54) **EXTERNAL STITCHING USB EXTENSION CHARGING CABLE FOR BAG**

(71) Applicant: **Riling Chen**, Guangdong (CN)

(72) Inventor: **Riling Chen**, Guangdong (CN)

(73) Assignee: **Wanxinda (Guangzhou) Technology Product Co., Ltd.**, Guangzhou (CN)

(**) Term: **15 Years**

(21) Appl. No.: **29/618,386**

(22) Filed: **Sep. 21, 2017**

(51) **LOC (11) Cl.** **13-03**

(52) **U.S. Cl.**
USPC **D13/147**

(58) **Field of Classification Search**

USPC D13/133, 146, 147, 154, 184, 199
 CPC H01R 13/58; H01R 13/5845; H01R 13/02;
 H01R 13/03; H01R 13/405; H01R
 13/648; H01R 13/506; H01R 13/516;
 H01R 12/57; H01R 13/6585; H01R
 24/60; H01R 2107/00; H01R 13/518;
 H01R 13/627; H01R 13/6315; H01R
 13/6453; H01R 13/6586; H01R 13/6597;
 B29C 70/84; B29C 70/88; B29C 70/885

See application file for complete search history.

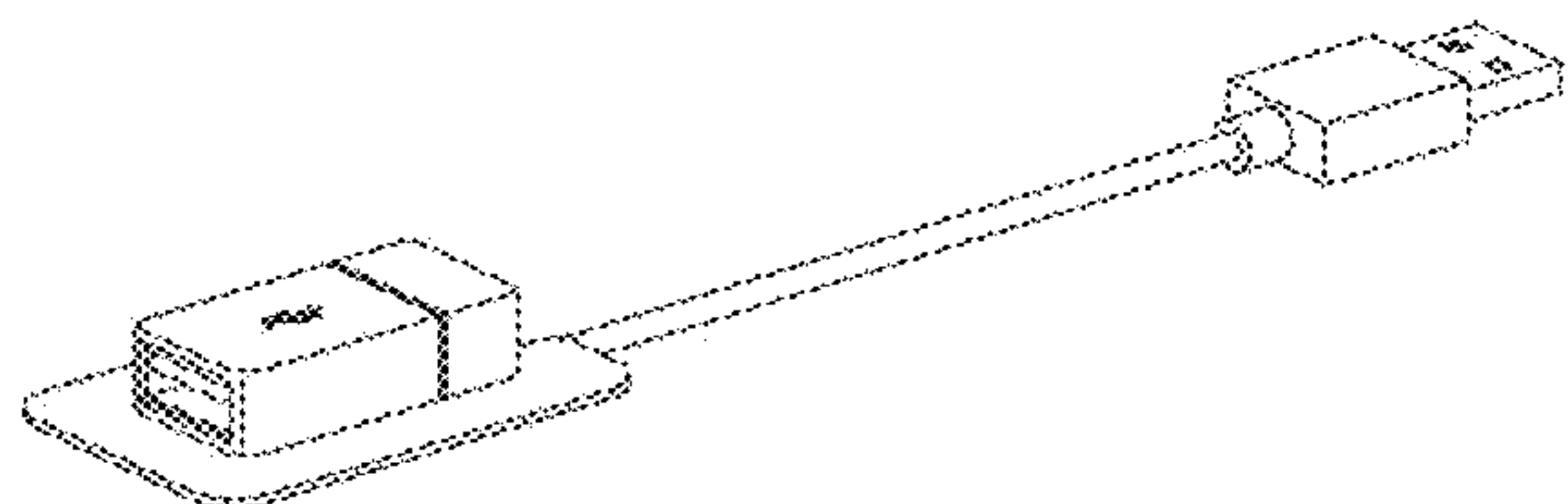

(56) **References Cited**

U.S. PATENT DOCUMENTS

D609,184 S *	2/2010	Liu	D13/147
D680,539 S *	4/2013	Kim	D14/433
D699,188 S *	2/2014	Akana	D13/147
D714,731 S *	10/2014	Lee	D13/147
D741,808 S *	10/2015	Shim	D13/147
D784,340 S *	4/2017	Laffon de Mazieres	D14/433
D800,731 S *	10/2017	He	D14/433
D817,889 S *	5/2018	Akana	D13/147

* cited by examiner

Primary Examiner — Daniel Bui

(57) **CLAIM**

The ornamental design for an external stitching USB extension charging cable for bag, as shown and described.

DESCRIPTION

FIG. 1 is a perspective view of a external stitching USB extension charging cable for bag showing my new design; FIG. 2 is a front elevational view thereof; FIG. 3 is a rear elevational view thereof; FIG. 4 is a right side view thereof; FIG. 5 is a left side view thereof; FIG. 6 is a bottom plan view thereof; and, FIG. 7 is a top plan view thereof.

1 Claim, 7 Drawing Sheets



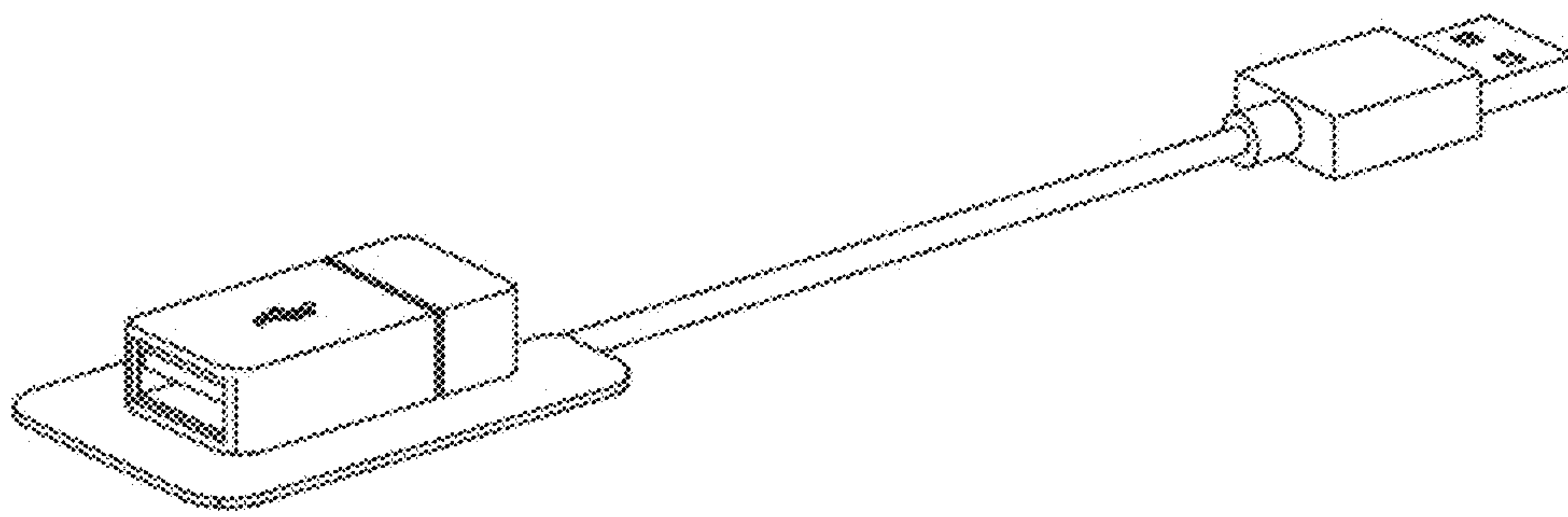

FIG. 1

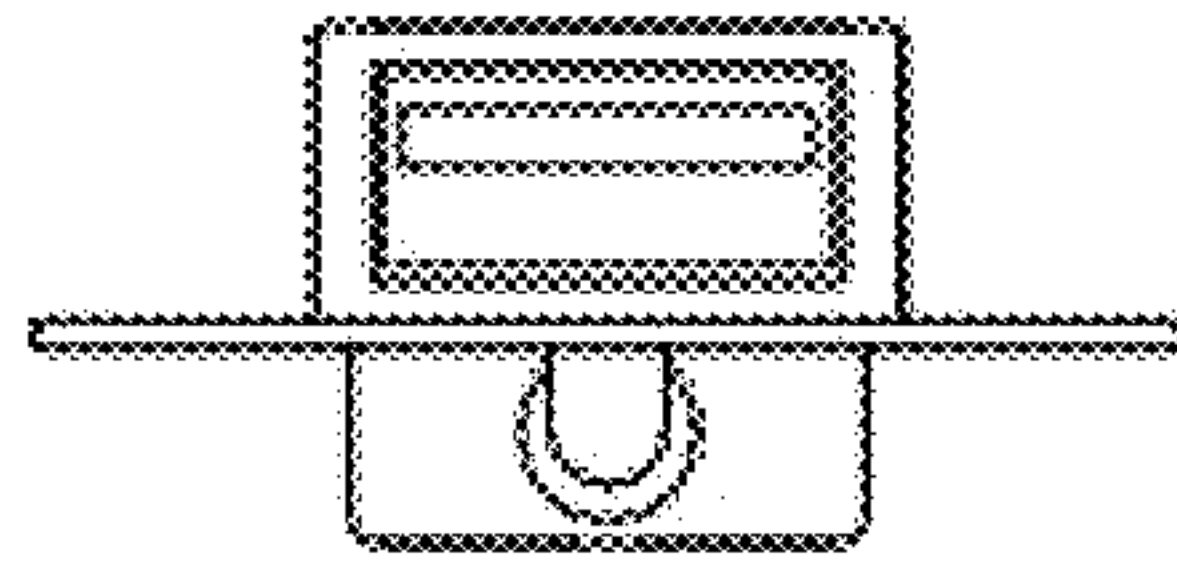

FIG. 2

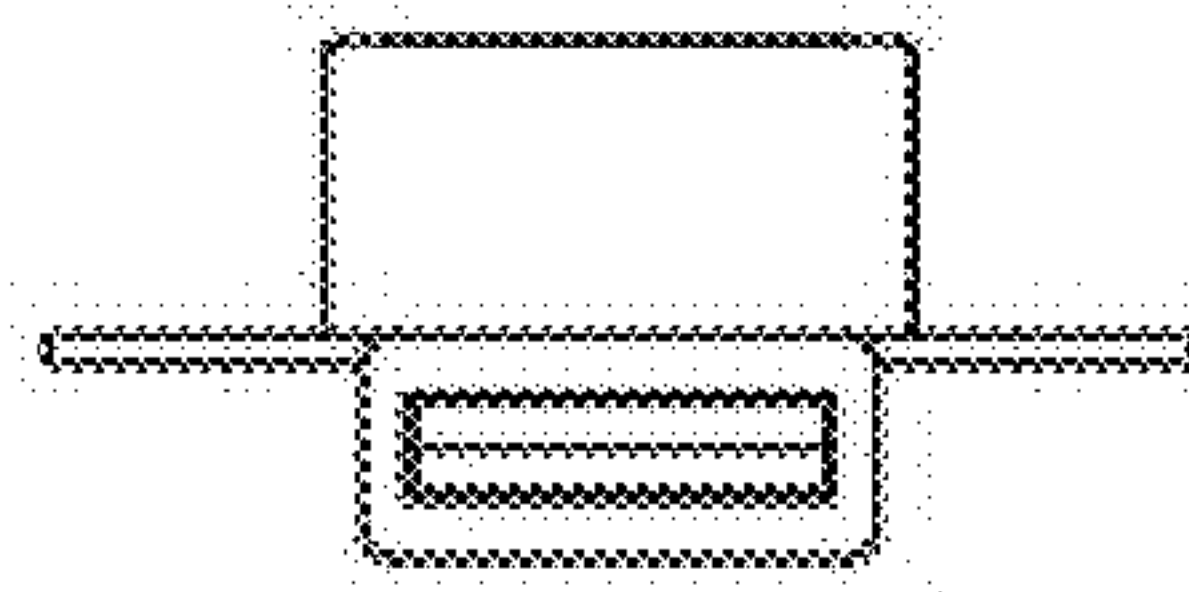

FIG. 3

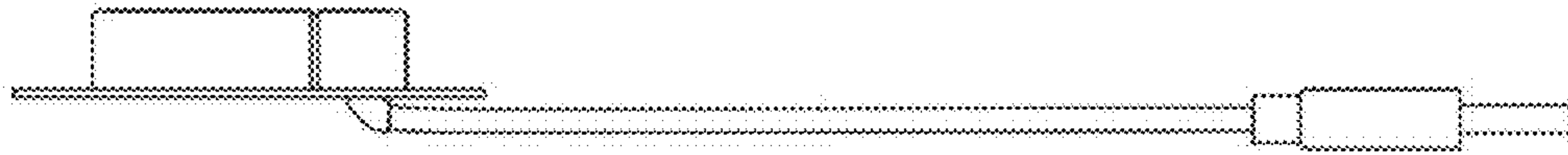

FIG. 4

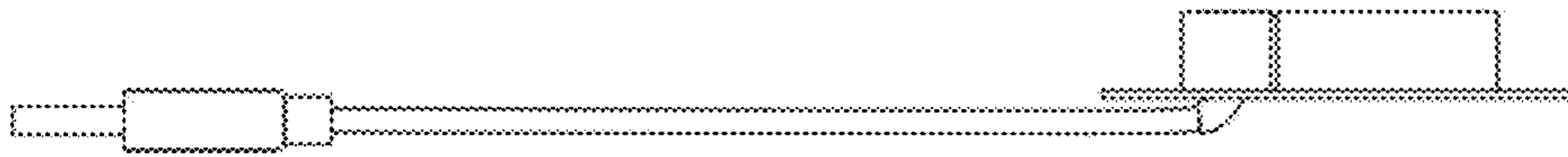

FIG. 5

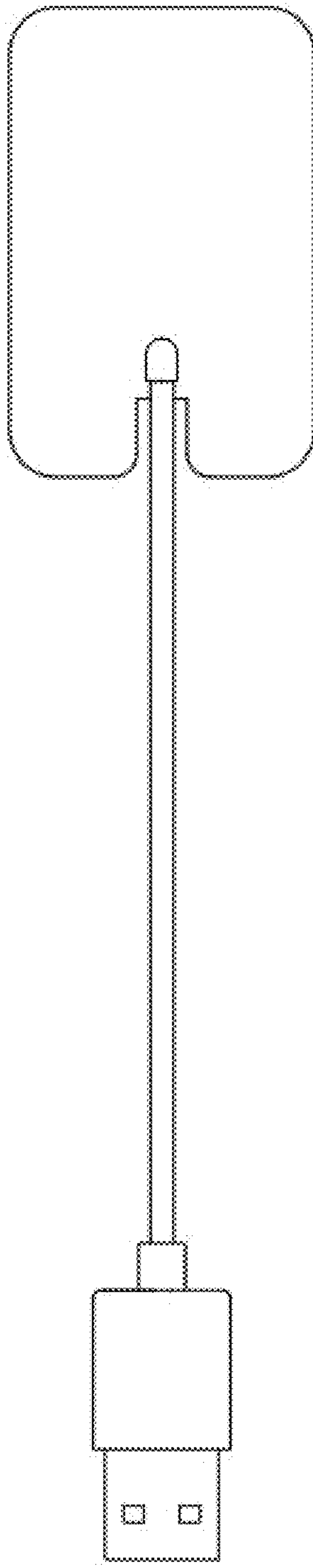

FIG. 6

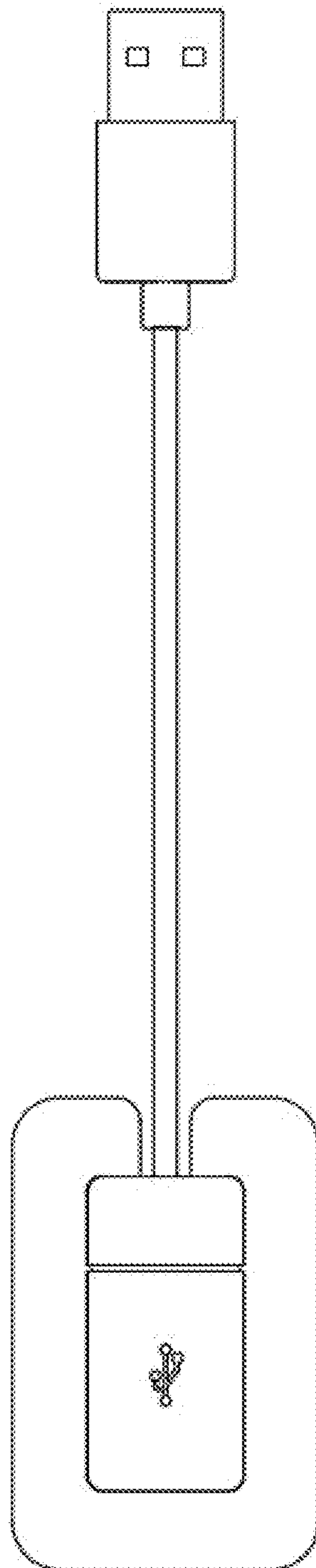

FIG. 7