



US00D826170S

(12) **United States Design Patent**
Mastel

(10) **Patent No.:** **US D826,170 S**

(45) **Date of Patent:** **** Aug. 21, 2018**

(54) **TERMINAL**

(71) Applicant: **WAGO Verwaltungsgesellschaft mbH**,
Minden (DE)

(72) Inventor: **Rudolf Mastel**, Porta Westfalica (DE)

(73) Assignee: **WAGO Verwaltungsgesellschaft mbH**,
Minden (DE)

(**) Term: **15 Years**

(21) Appl. No.: **29/597,533**

(22) Filed: **Mar. 17, 2017**

(30) **Foreign Application Priority Data**

Sep. 19, 2016 (EM) 003383967-0007

(51) **LOC (11) Cl.** **13-03**

(52) **U.S. Cl.**
USPC **D13/147**

(58) **Field of Classification Search**

USPC D13/123, 133, 146, 147, 154, 184, 199
CPC . H01R 4/48; H01R 9/24; H01R 13/02; H01R
13/2407; H01R 13/52; H01R 13/62;
H01R 13/629; H01R 13/633; H01R
13/639

See application file for complete search history.

(56) **References Cited**

U.S. PATENT DOCUMENTS

D624,503 S * 9/2010 Severing D13/147
D625,270 S * 10/2010 Schafmeister D13/147

D626,509 S * 11/2010 Severing D13/147
D641,703 S * 7/2011 Severing D13/146
D739,822 S * 9/2015 Severing D13/146
D756,301 S * 5/2016 Wu D13/133
D756,304 S * 5/2016 Wu D13/146
2015/0044897 A1* 2/2015 Wu H01R 4/48
439/352
2016/0204526 A1* 7/2016 Wu H01R 4/4809
439/816

* cited by examiner

Primary Examiner — Daniel Bui

(74) *Attorney, Agent, or Firm* — Muncy, Geissler, Olds &
Lowe, P.C.

(57) **CLAIM**

The ornamental design for a terminal, as shown and
described.

DESCRIPTION

FIG. 1 is a front perspective view of a terminal showing my
new design.

FIG. 2 is a front view thereof.

FIG. 3 is a rear view thereof.

FIG. 4 is a left side view thereof.

FIG. 5 is a right side view thereof.

FIG. 6 is a top view thereof; and,

FIG. 7 is a bottom view thereof.

The evenly-spaced broken lines illustrate environment that
does not form part of the claim.

1 Claim, 7 Drawing Sheets

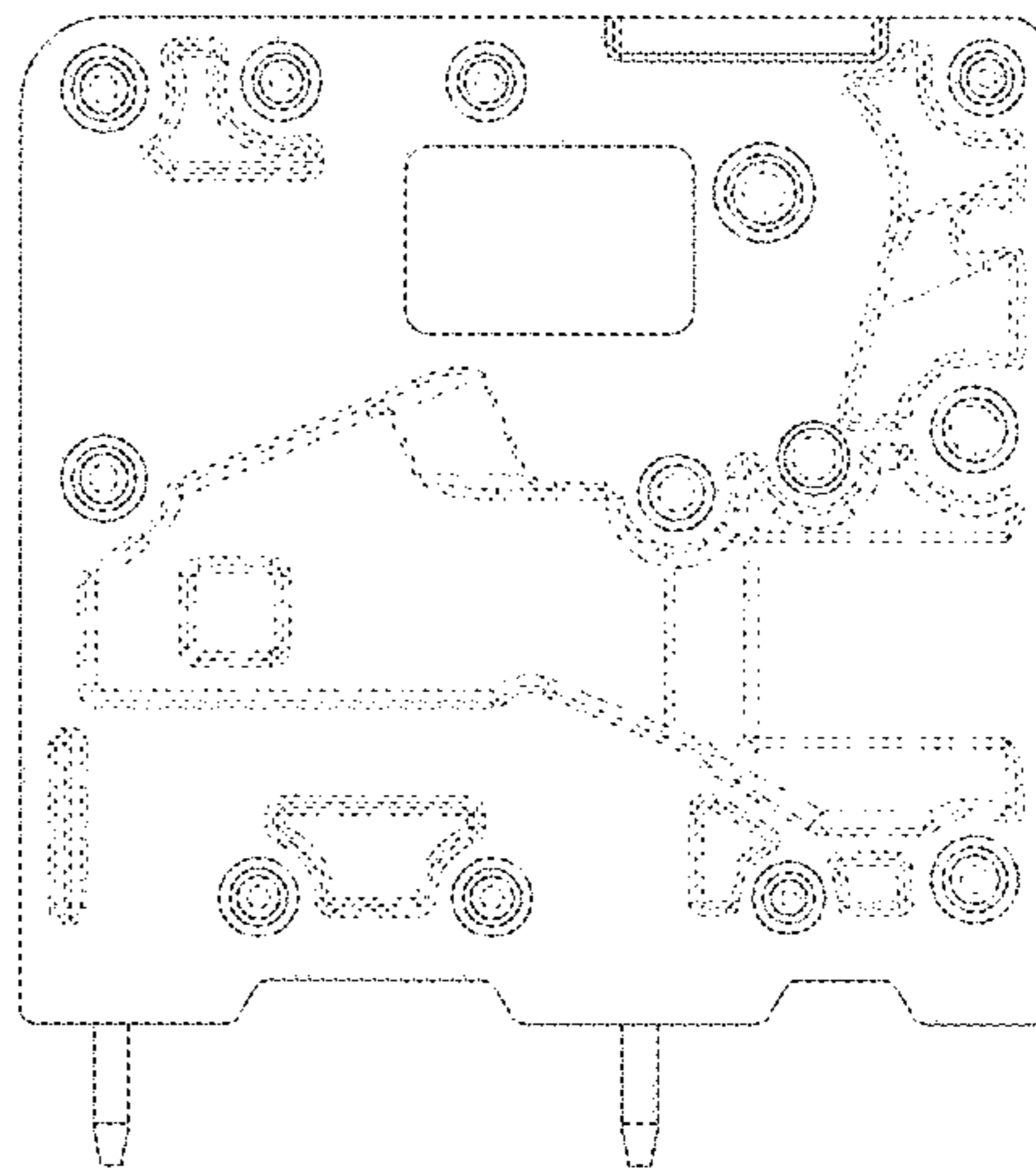
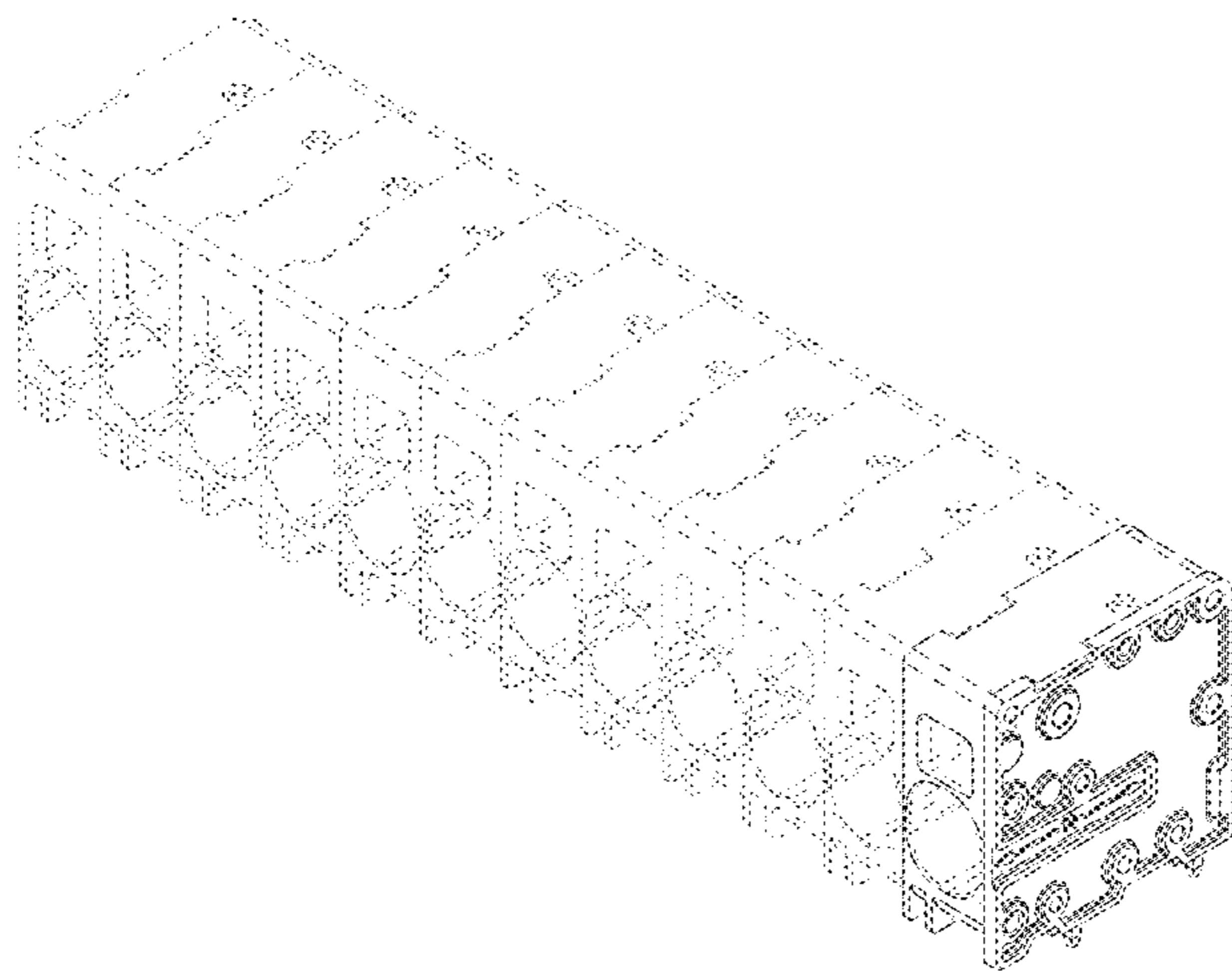

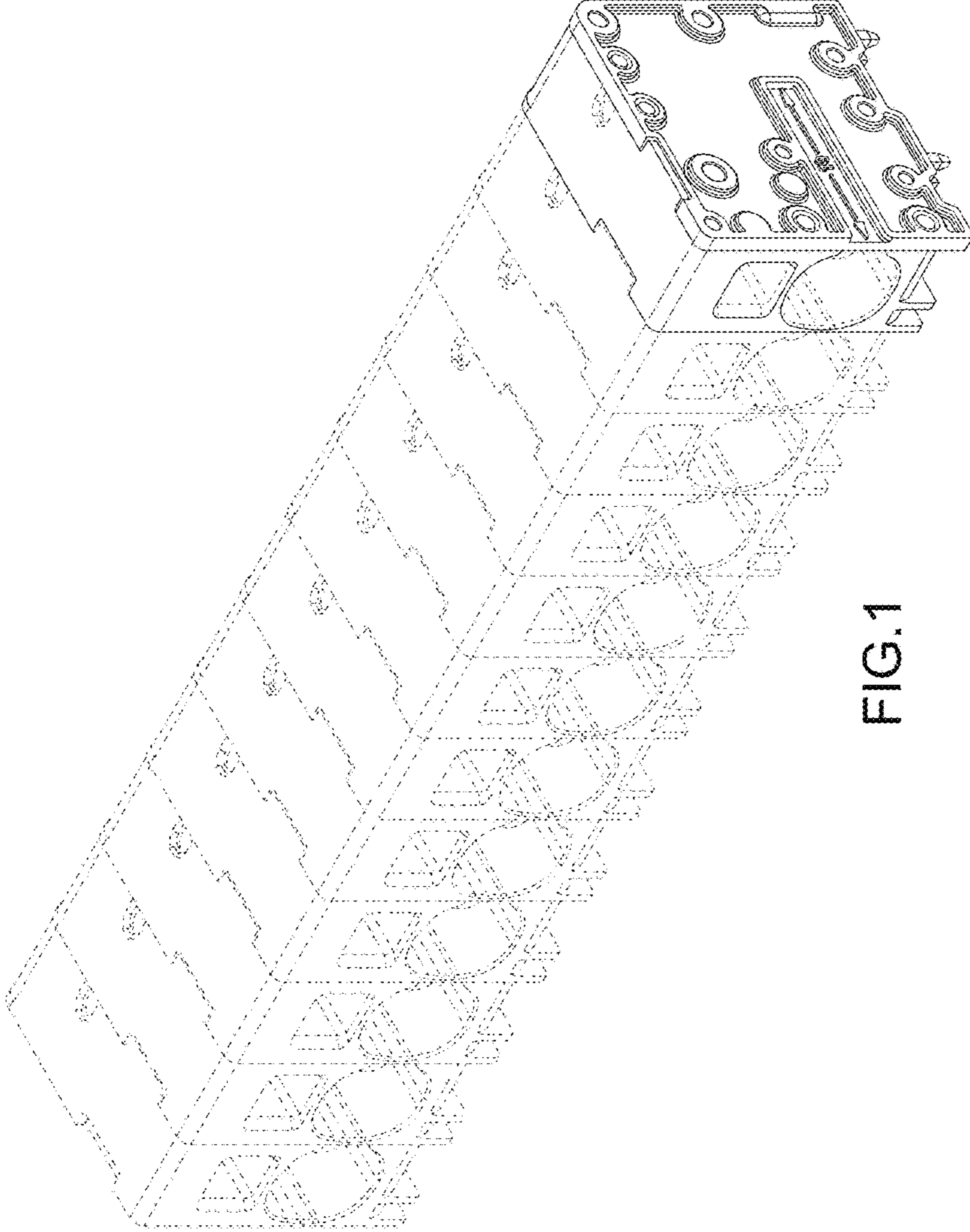

FIG. 1

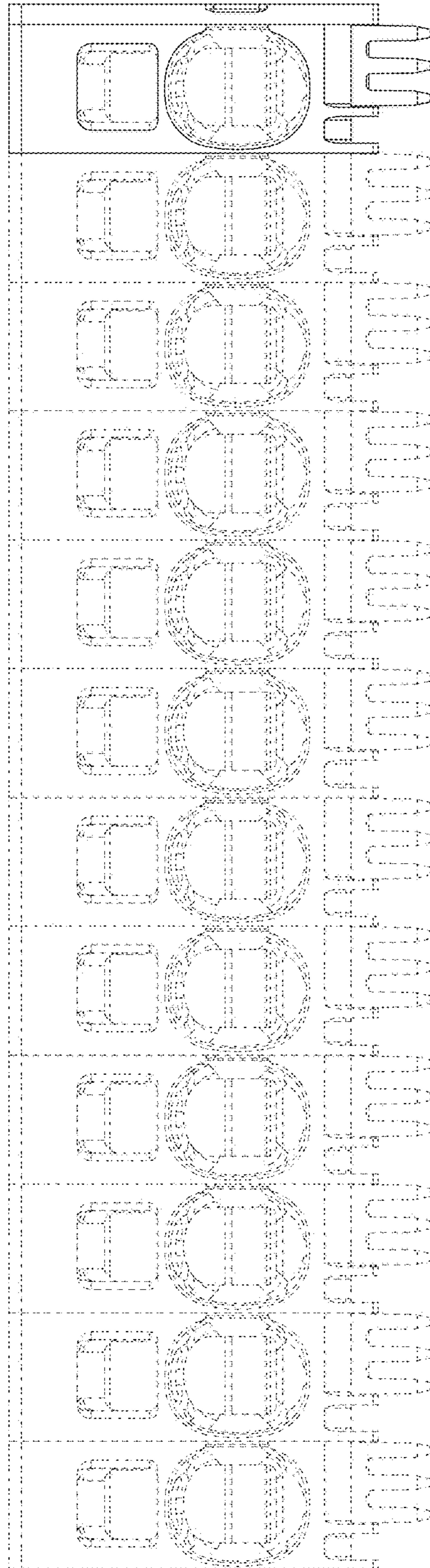

FIG.2

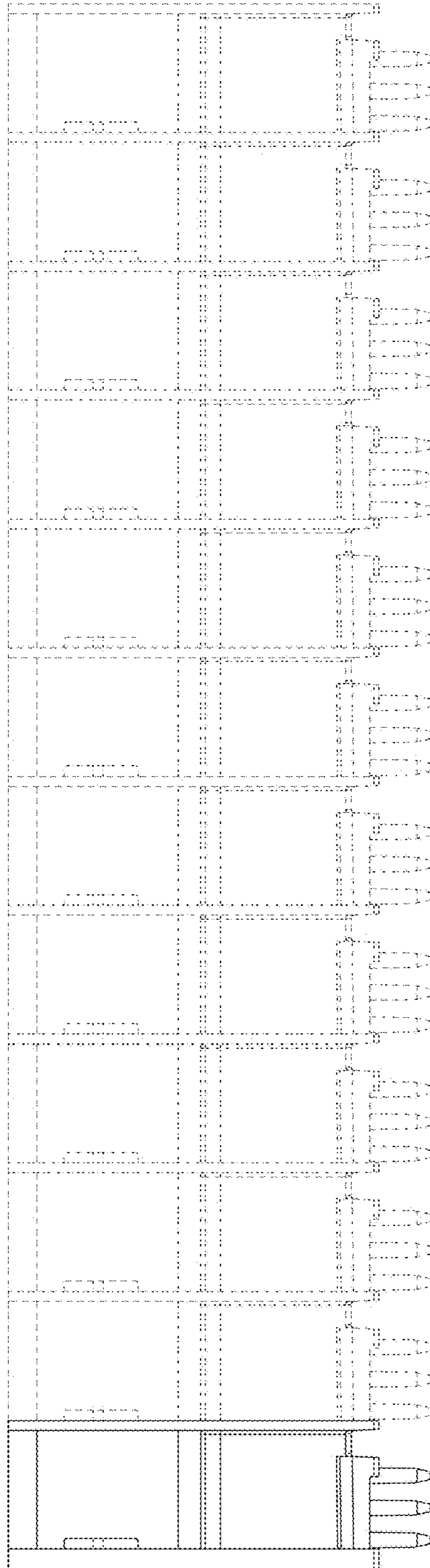

FIG. 3

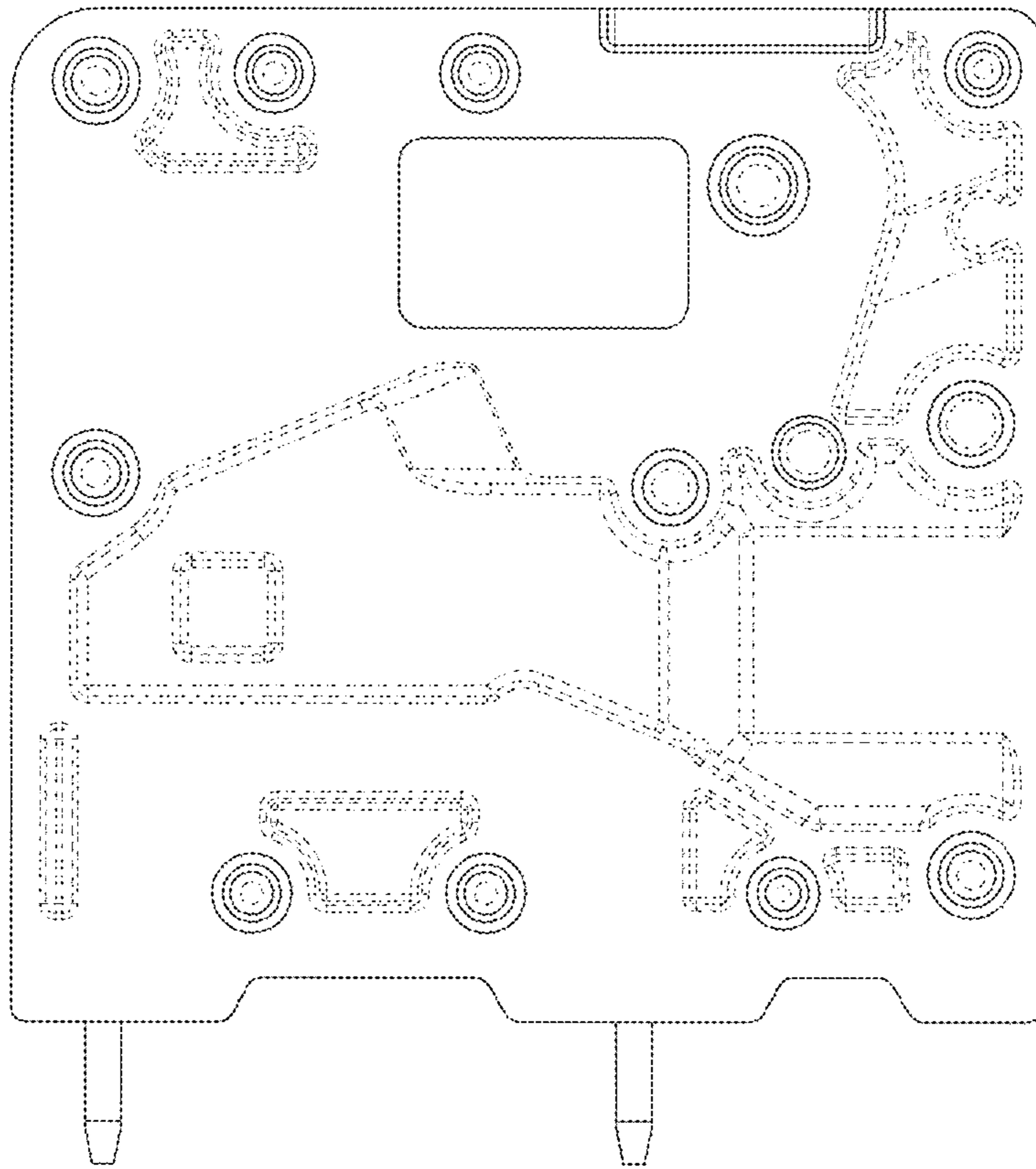

FIG. 4

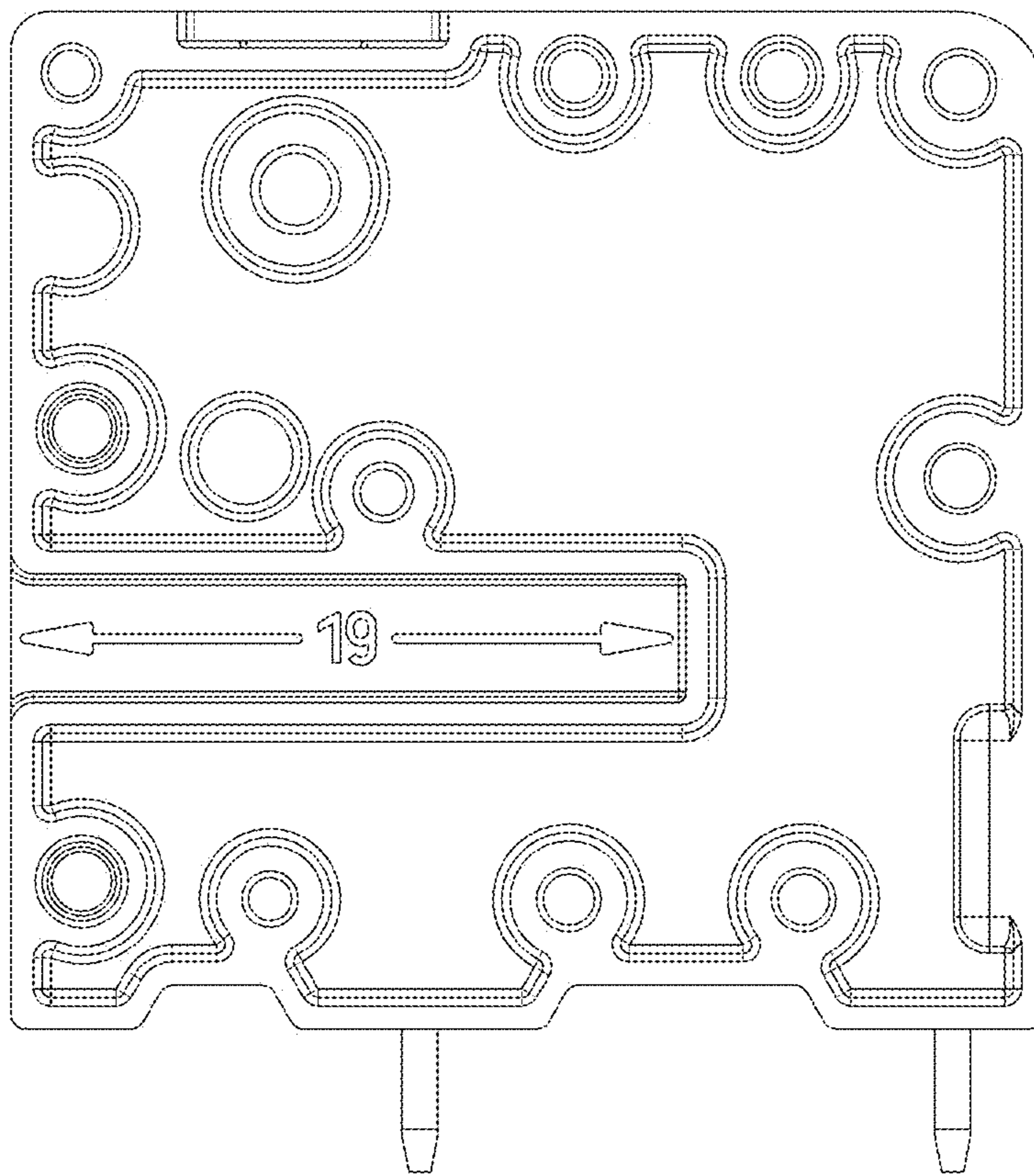

FIG. 5

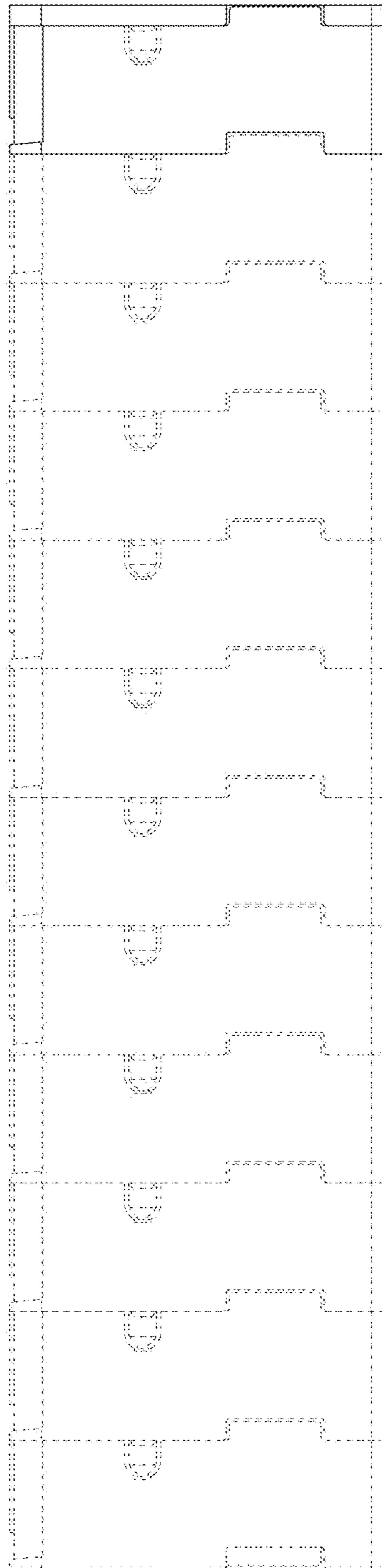

FIG. 6

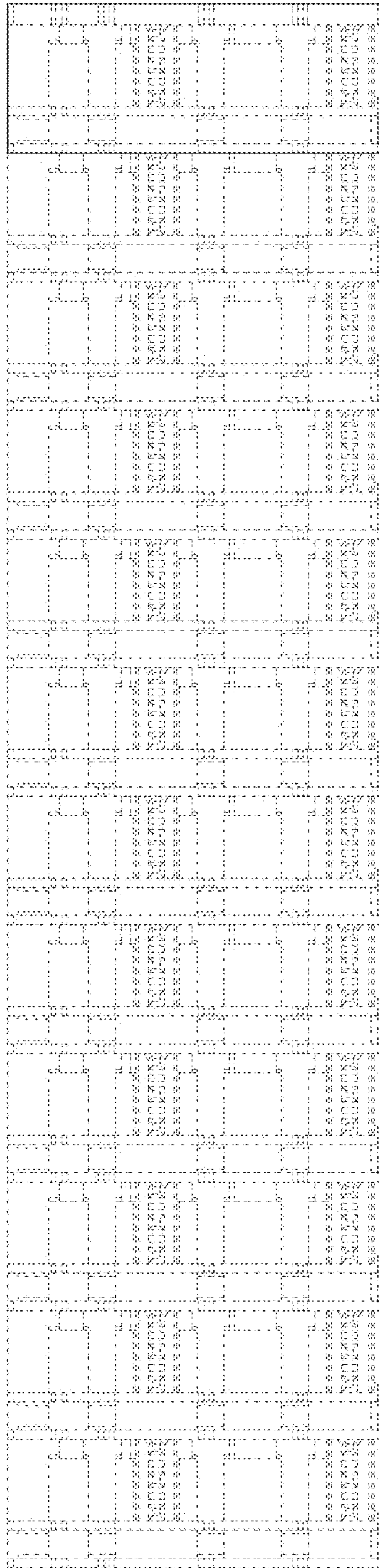

FIG. 7