



US00D826093S

(12) **United States Design Patent** (10) **Patent No.:** **US D826,093 S**
Manzoni et al. (45) **Date of Patent:** **** Aug. 21, 2018**

(54) **CAR, TOY REPLICA AND/OR OTHER REPLICAS**

(71) Applicant: **Ferrari S.p.A.**, Modena (IT)

(72) Inventors: **Flavio Manzoni**, Maranello (IT);
Johann Lemercier, Serramazzone (IT)

(73) Assignee: **Ferrari S.p.A.**, Modena (IT)

(**) Term: **15 Years**

(21) Appl. No.: **29/595,460**

(22) Filed: **Feb. 28, 2017**

(30) **Foreign Application Priority Data**

Aug. 31, 2016 (EM) 003359538
Aug. 31, 2016 (EM) 003359553

(51) **LOC (11) Cl.** **12-08**

(52) **U.S. Cl.**
USPC **D12/92**

(58) **Field of Classification Search**
USPC D12/86, 90-92, 88; D21/421, 433, 434;
296/181.1, 181.5

CPC B62D 35/00; B62D 25/00; B62D 25/06;
B62D 33/00

See application file for complete search history.

(56) **References Cited**

U.S. PATENT DOCUMENTS

D727,212 S * 4/2015 Menegon D12/92
D741,753 S * 10/2015 Perini D12/92

D745,439 S * 12/2015 Manzoni D12/92
D753,548 S * 4/2016 Gilles D12/92
D753,549 S * 4/2016 Manzoni D12/88
D755,674 S * 5/2016 Perini D12/92
D767,446 S * 9/2016 Stephenson D12/88
D768,035 S * 10/2016 Goto D12/88
D774,415 S * 12/2016 Menegon D12/88
D780,063 S * 2/2017 Stephenson D12/88
D781,747 S * 3/2017 Stephenson D12/88
D781,748 S * 3/2017 Manzoni D12/88
D781,749 S * 3/2017 Perini D12/88
D788,642 S * 6/2017 Manzoni D12/88
D801,227 S * 10/2017 Stephenson D12/88

* cited by examiner

Primary Examiner — Melody N Brown

(74) *Attorney, Agent, or Firm* — Cowan, Liebowitz & Latman, P.C.

(57) **CLAIM**

The ornamental design for a car, toy replica and/or other replicas, as shown and described.

DESCRIPTION

FIG. 1 is a front perspective view of a car, toy replica and/or other replicas showing my new design;
FIG. 2 is a rear perspective view thereof;
FIG. 3 is a front view thereof;
FIG. 4 is a rear view thereof;
FIG. 5 is a side elevational view, the opposite side is a mirror image thereof; and,
FIG. 6 is a top plan view thereof.

1 Claim, 6 Drawing Sheets

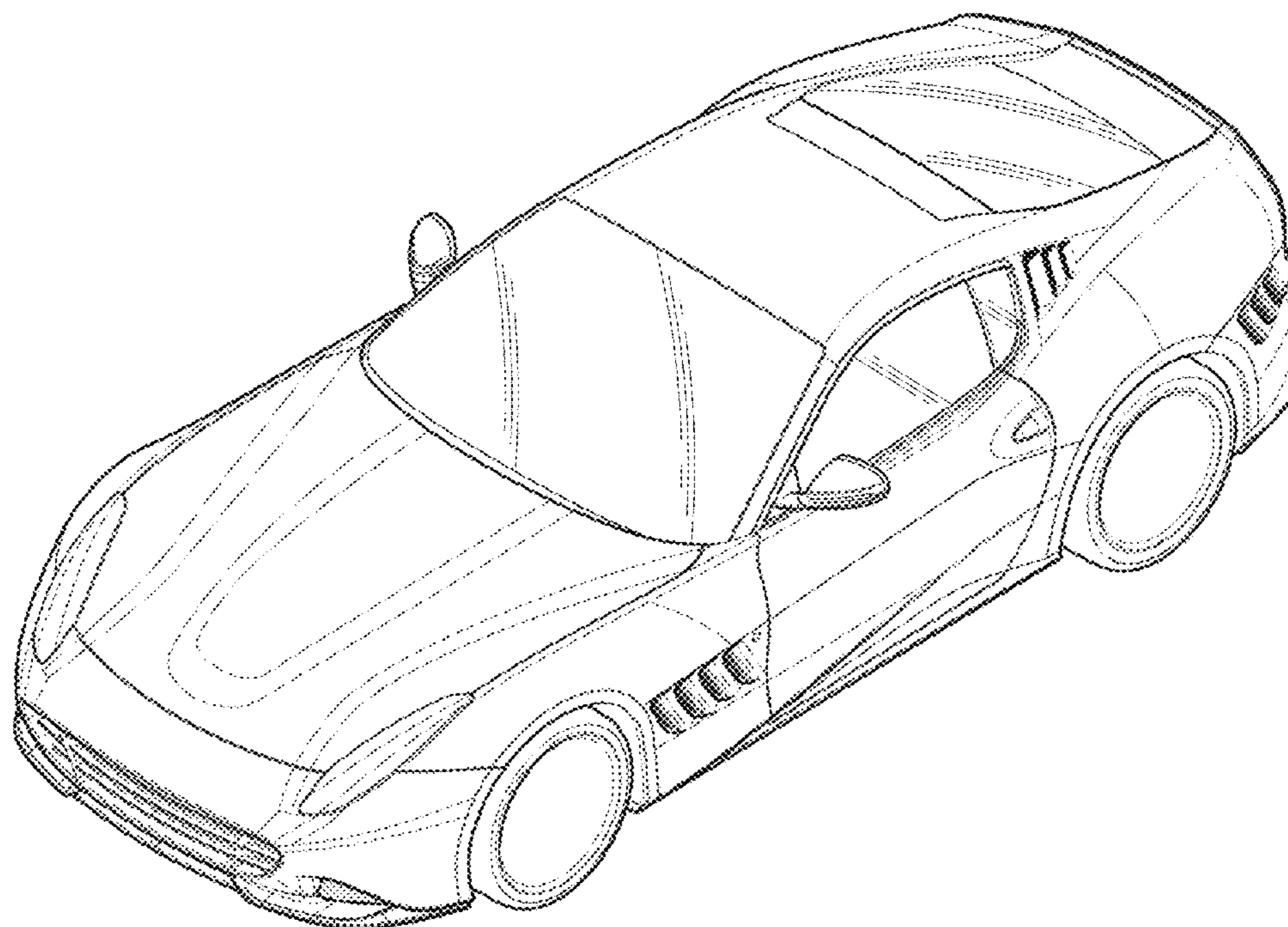

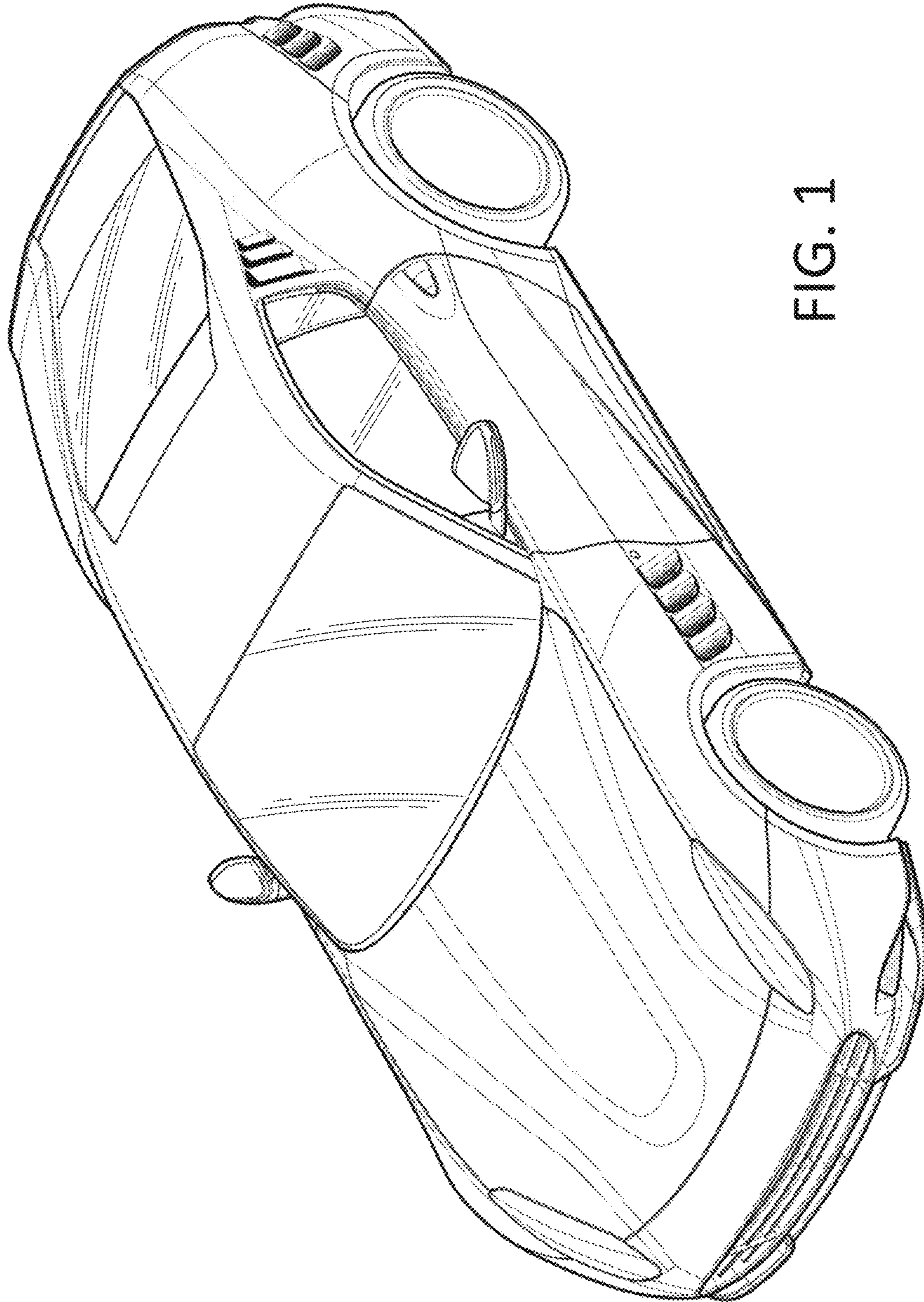

FIG. 1

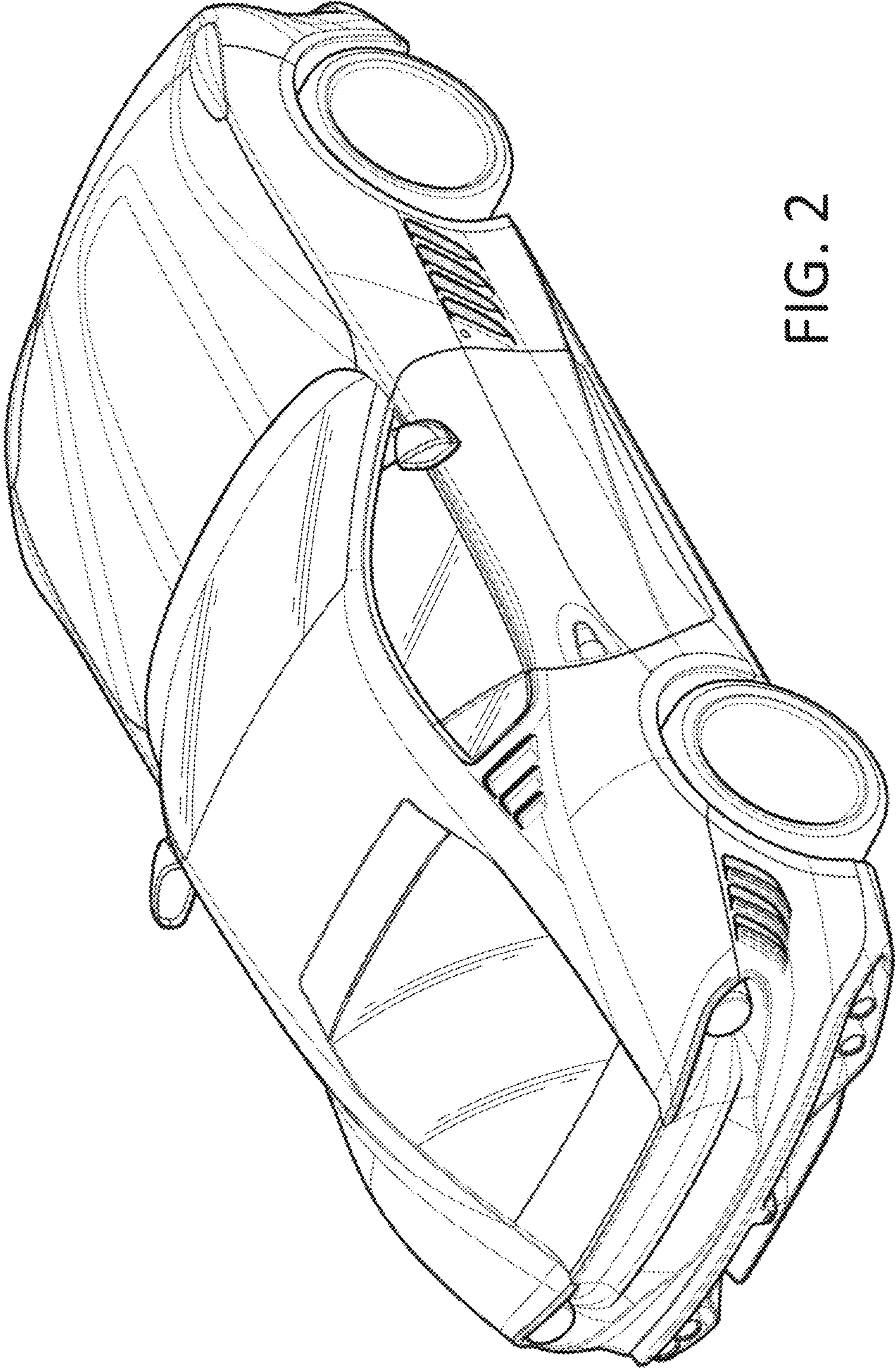

FIG. 2

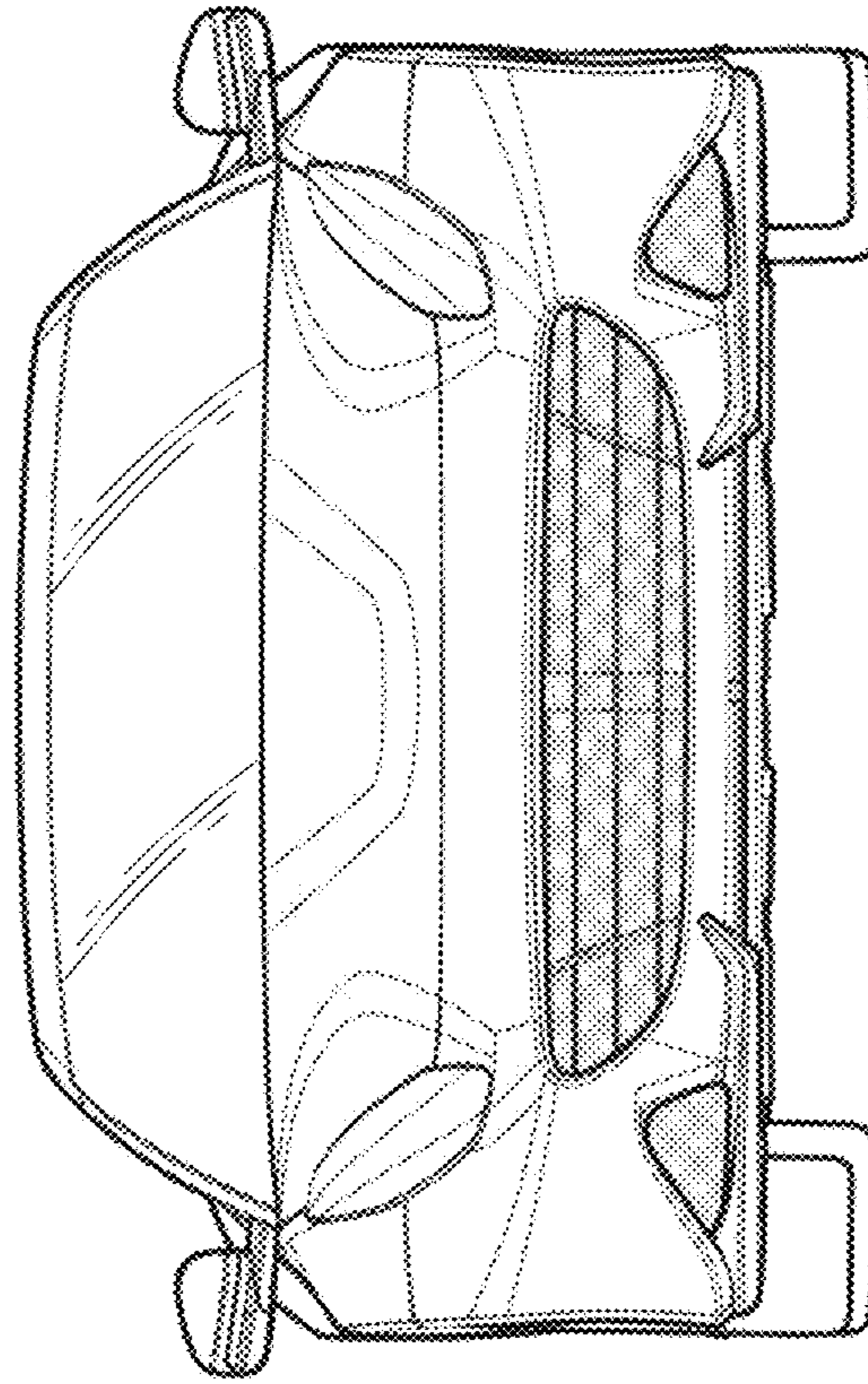

FIG. 3

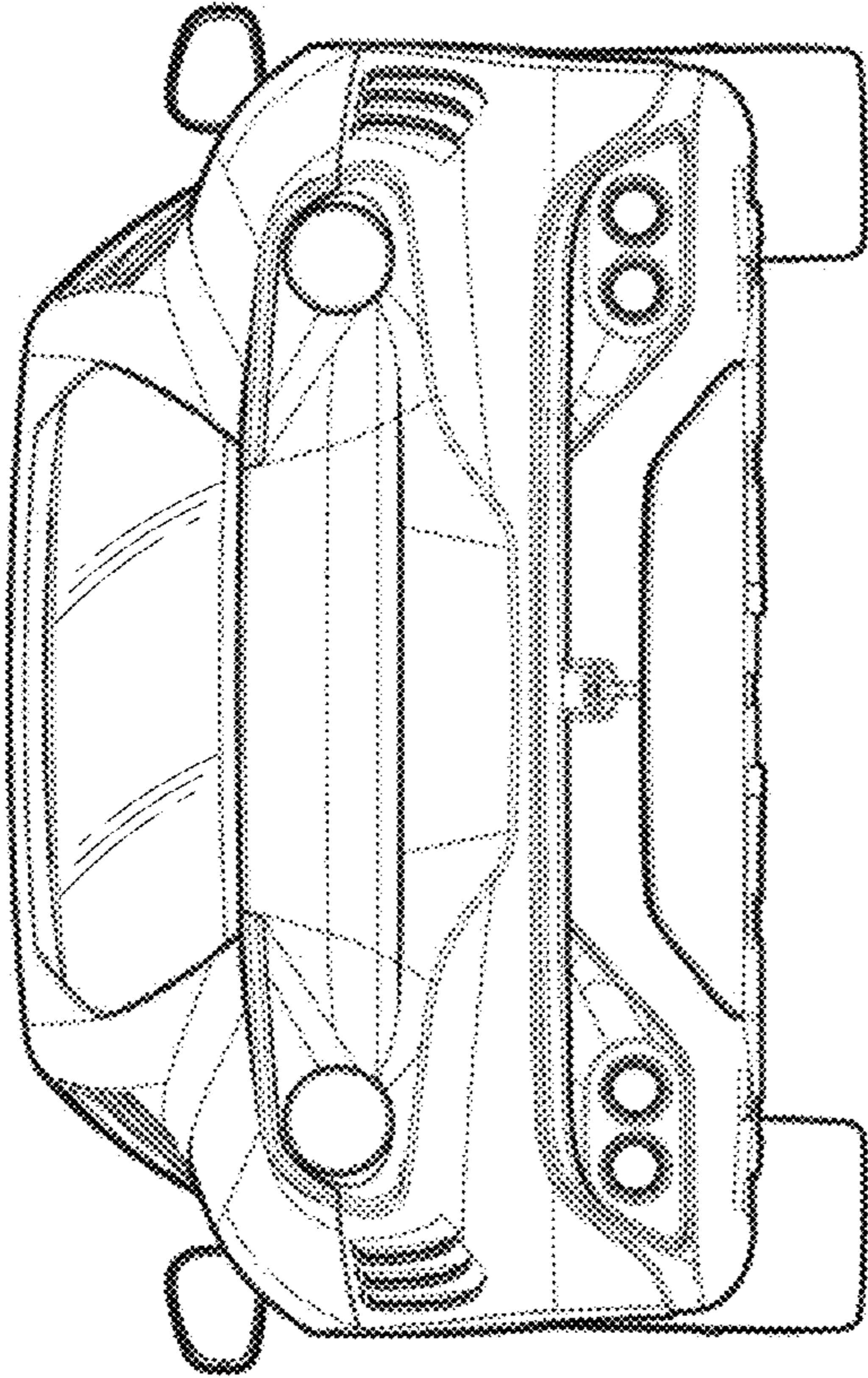

FIG. 4

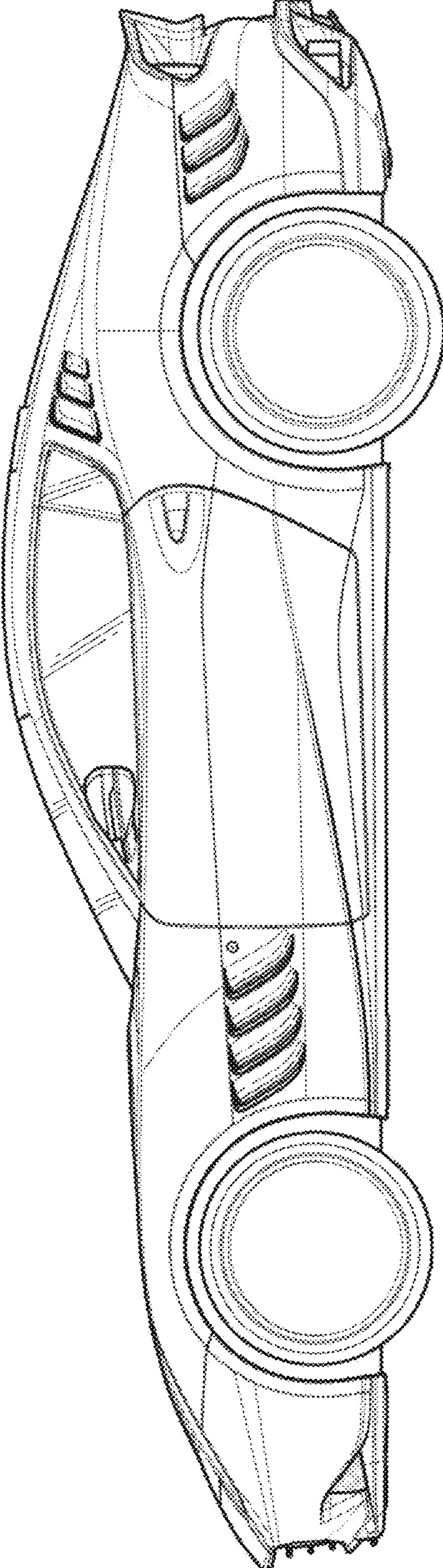

FIG. 5

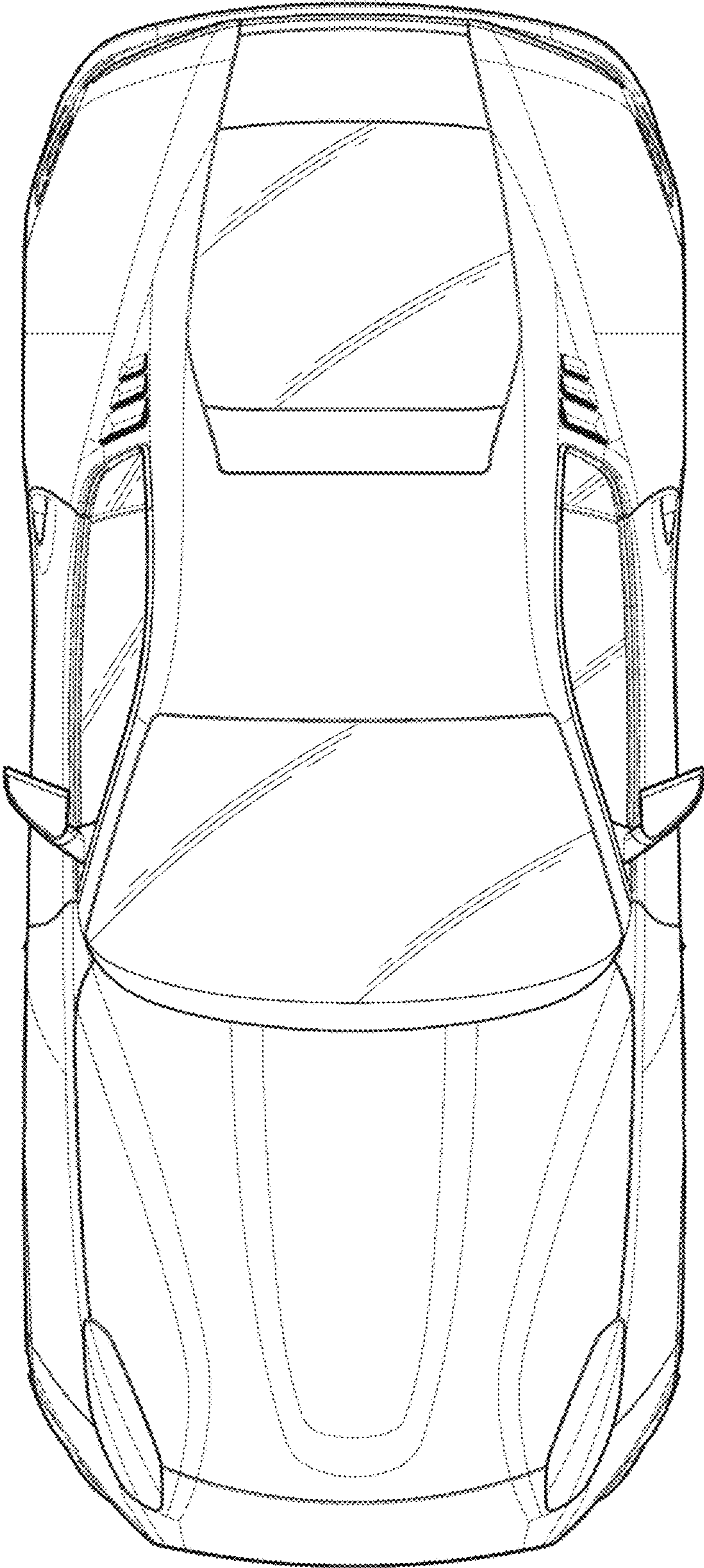

FIG. 6