



US00D826065S

(12) **United States Design Patent**
Kellman

(10) **Patent No.:** **US D826,065 S**

(45) **Date of Patent:** **** Aug. 21, 2018**

(54) **SPRAYER WITH NOZZLE ON TANK**

(71) Applicant: **Gary Kellman**, St. Peters, MO (US)

(72) Inventor: **Gary Kellman**, St. Peters, MO (US)

(**) Term: **15 Years**

(21) Appl. No.: **29/592,538**

(22) Filed: **Jan. 31, 2017**

(51) **LOC (11) Cl.** **09-01**

(52) **U.S. Cl.**

USPC **D9/682**; D9/448; D6/542

(58) **Field of Classification Search**

USPC D9/414, 415, 424, 425, 434, 435, 436,
D9/443, 444-452, 454-456, 499, 529,
D9/682, 685, 686; D7/387, 391, 392,
D7/392.1, 396.1, 396.2, 396.3, 396.4,
D7/397, 398, 401.1, 507, 509-511, 538,
D7/900; D3/202, 203.2; D28/91, 91.1;
D6/542

CPC .. A61J 1/00; A61J 1/1412; B65D 1/00; B65D
1/02; B65D 1/10; B65D 1/46; B65D
2585/56; B65D 2585/545; B65D 41/00;
B65D 41/38; B65D 41/56; B65D 41/62;
B65D 47/00; B65D 47/06; B65D 47/08;
B65D 2543/00046; B65D 2543/00092;
B65D 2543/00296; B65D 5/46; B65D
2251/00

See application file for complete search history.

(56) **References Cited**

U.S. PATENT DOCUMENTS

- D266,987 S * 11/1982 Perez Carasa Y Perez de
Guzman D9/448
- D281,054 S * 10/1985 Menrad D28/89
- 5,192,006 A * 3/1993 Van Brocklin B05B 11/304
222/321.9

(Continued)

Primary Examiner — Michael A. Pratt

Assistant Examiner — Wendy L Arminio

(74) *Attorney, Agent, or Firm* — Charles McCloskey

(57) **CLAIM**

The ornamental design for a sprayer with nozzle on tank, as shown and described.

DESCRIPTION

FIG. 1 is a front view of a first embodiment of the present invention;

FIG. 2 is a left side view thereof;

FIG. 3 is a back view thereof and opposite that shown in FIG. 1;

FIG. 4 is a right side view thereof;

FIG. 5 is a top view thereof;

FIG. 6 is a bottom view thereof;

FIG. 7 is a perspective view thereof;

FIG. 8 is an exploded perspective view thereof showing the manner of assembly with an unclaimed cap drawn in broken lines;

FIG. 9 is a perspective view of the design of FIG. 1 shown in a position of use with an unclaimed cap drawn in broken lines placed on top of the sprayer with nozzle on tank;

FIG. 10 is a front view of a second embodiment thereof;

FIG. 11 is a left side view of FIG. 10;

FIG. 12 is a back view of FIG. 10 and opposite that shown in FIG. 10;

FIG. 13 is a right side view of FIG. 10;

FIG. 14 is a top view of FIG. 10;

FIG. 15 is a bottom view of FIG. 10;

FIG. 16 is a perspective view of FIG. 10;

FIG. 17 is an exploded perspective view thereof showing the manner of assembly with an unclaimed cap drawn in broken lines; and,

FIG. 18 is a perspective view of the design of FIG. 1 shown in a position of use with an unclaimed cap drawn in broken lines placed on top of the sprayer with nozzle on tank.

The broken lines illustrating a cap depict environment and form no part of the claimed design.

1 Claim, 4 Drawing Sheets

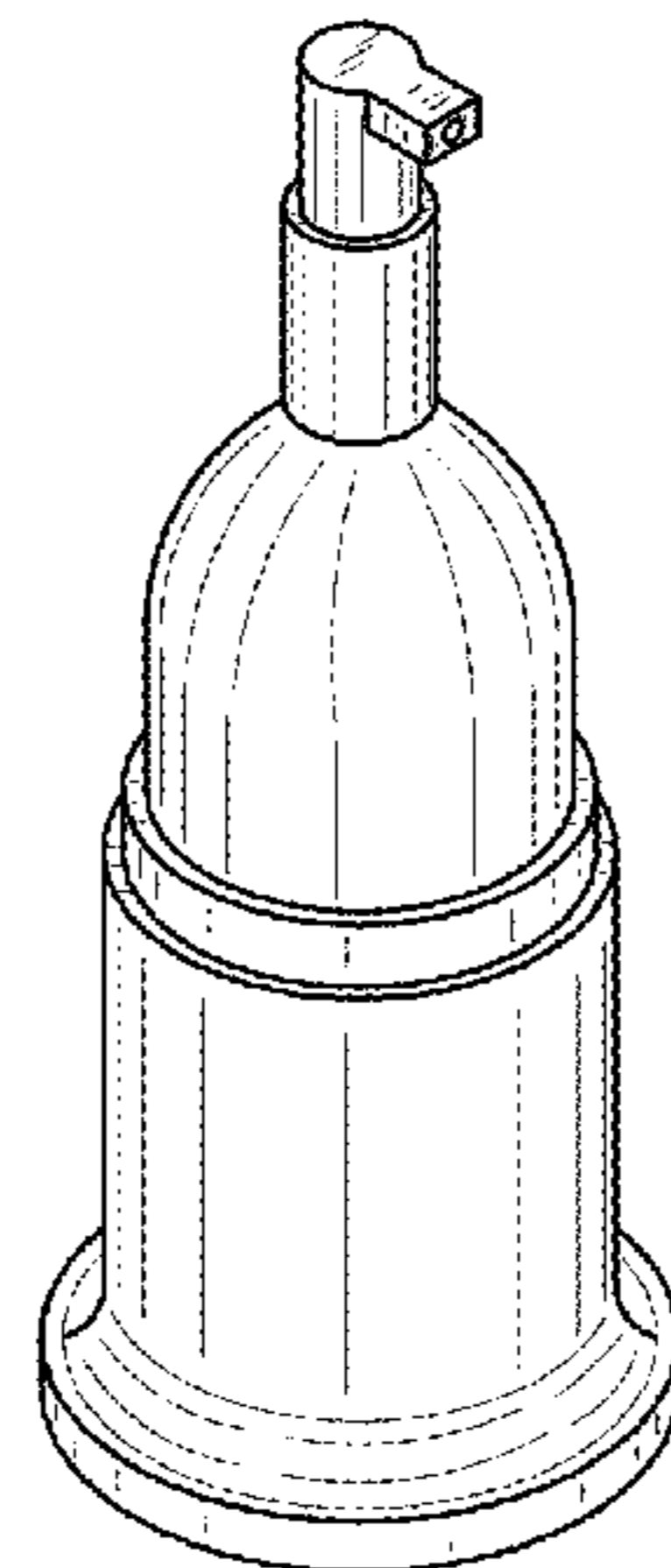
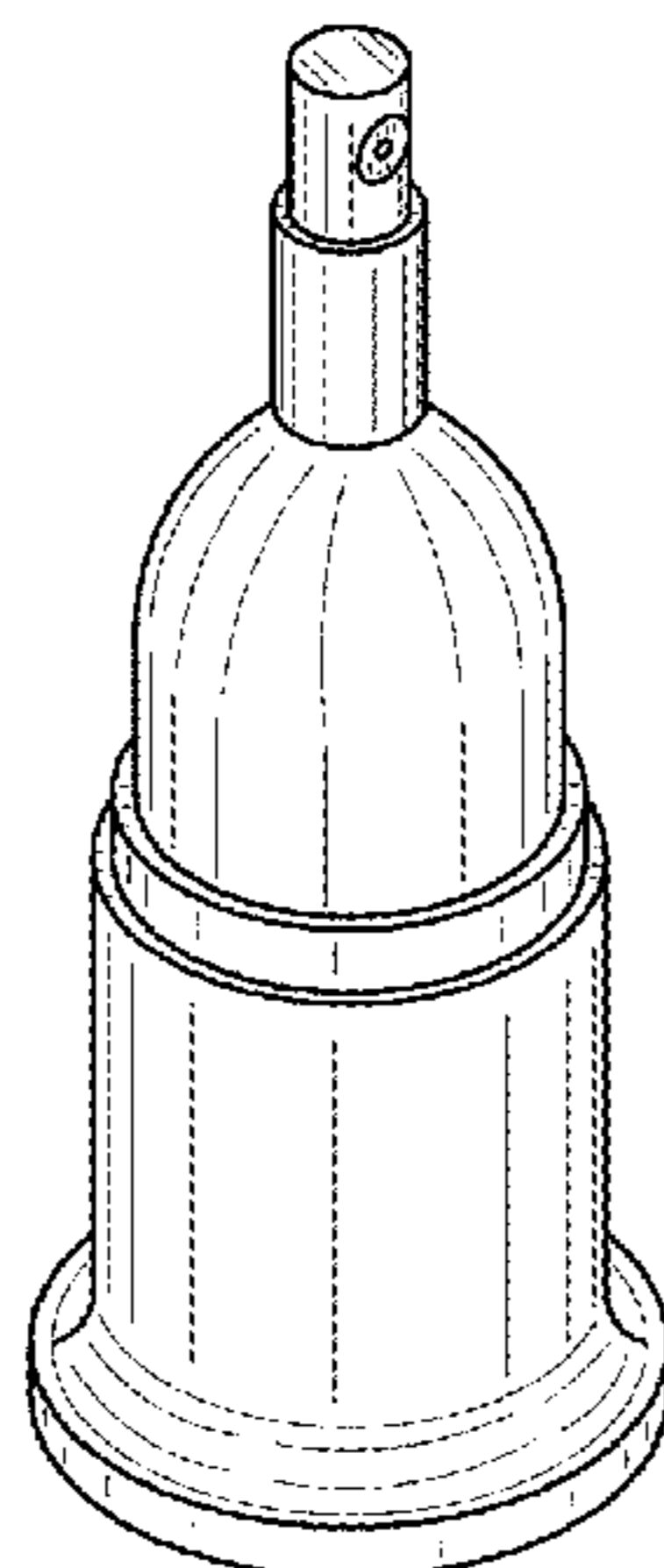

(56)

References Cited

U.S. PATENT DOCUMENTS

D347,571	S *	6/1994	Wacker	D9/452
D348,388	S *	7/1994	Kuzma	D9/575
D348,396	S *	7/1994	Kuzma	D9/575
D357,856	S *	5/1995	Kudo	D9/682
D377,755	S *	2/1997	Kotyuk	D9/542
D389,964	S *	1/1998	Lewandowski	401/139
D392,558	S *	3/1998	Monaghan	D9/682
D400,783	S *	11/1998	de Mourgues	D9/691
5,848,739	A *	12/1998	Wilkinson	B65D 83/0044 222/386
D404,293	S *	1/1999	Bertolini	D9/565
D404,295	S *	1/1999	Bertolini	D9/691
D419,864	S *	2/2000	Kuzma	D9/556
D429,629	S *	8/2000	Kuzma	D9/574
D443,202	S *	6/2001	Boussiquet	D9/500
D469,684	S *	2/2003	Lerolle	D9/682
D484,403	S *	12/2003	Crawford	D9/682
6,695,171	B2 *	2/2004	Walters	B05B 11/3001 222/153.13
D511,690	S *	11/2005	Garcia	D9/682
D536,972	S *	2/2007	van der Heijden	D6/542
D568,154	S *	5/2008	Arminak	D9/448
D574,707	S *	8/2008	Pietrowski	D9/448
D681,475	S *	5/2013	Park	D9/682
2007/0158365	A1 *	7/2007	Kim	B05B 11/007 222/207

* cited by examiner

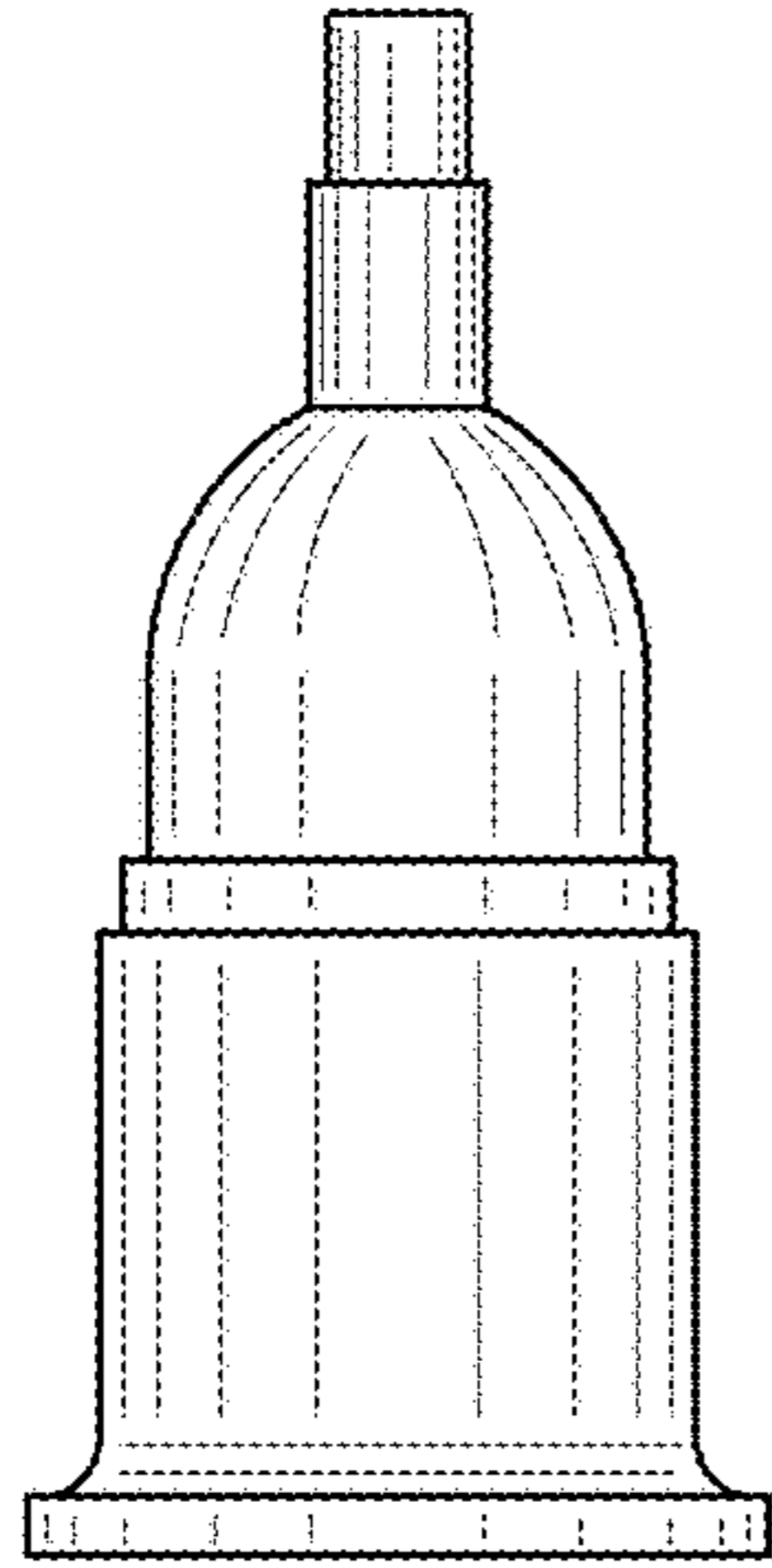

FIG. 1

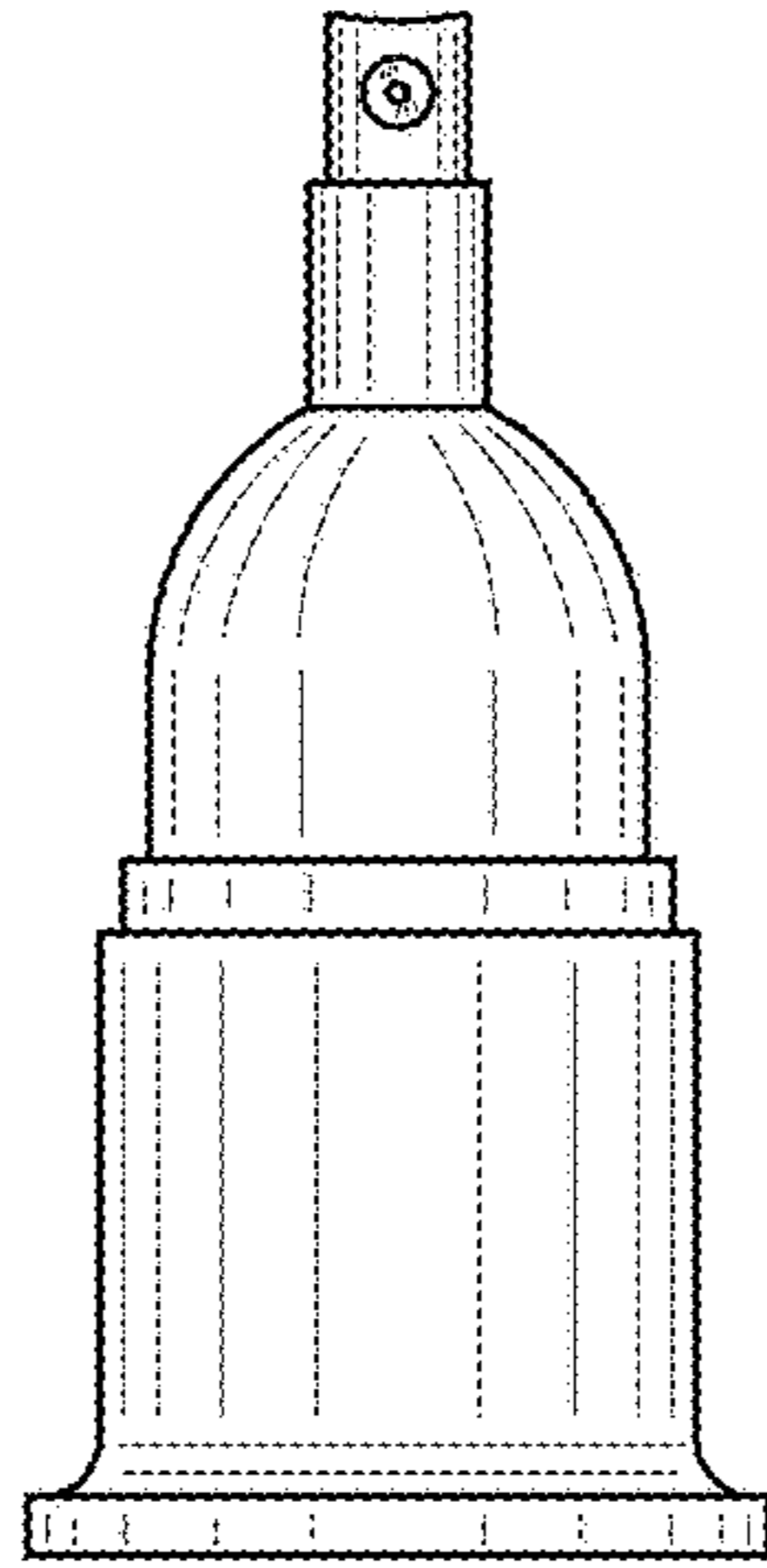

FIG. 2

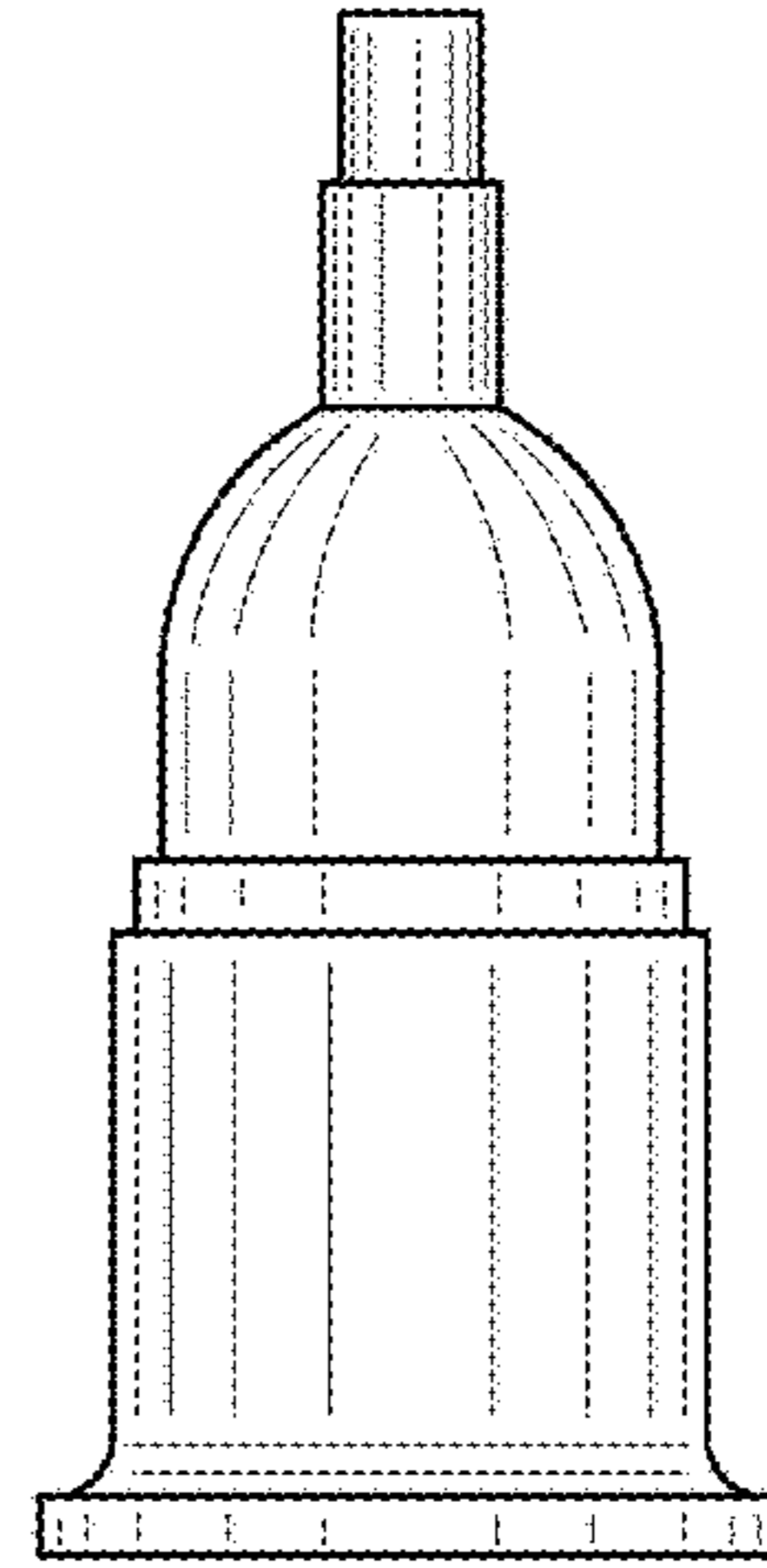

FIG. 3

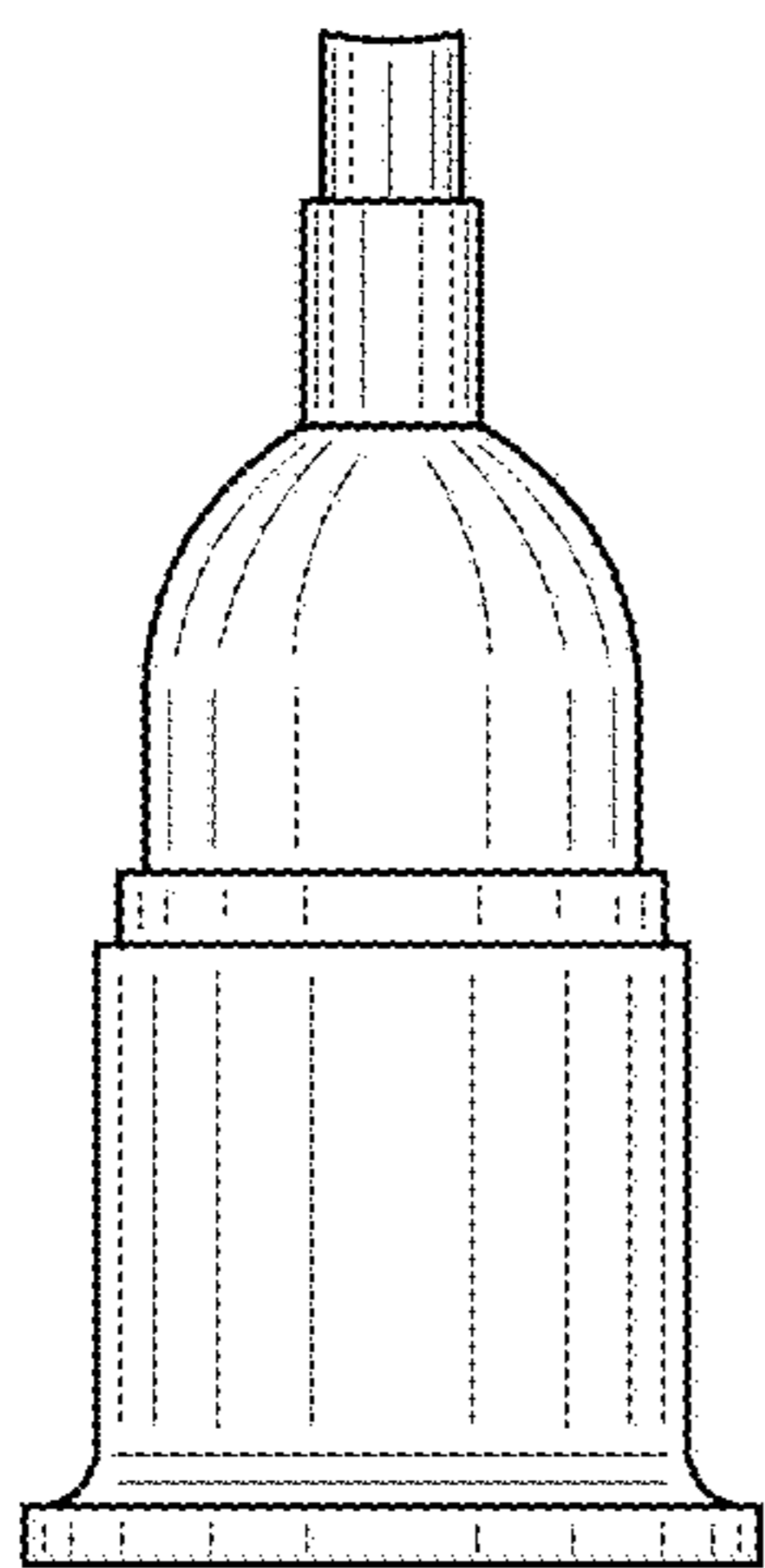

FIG. 4

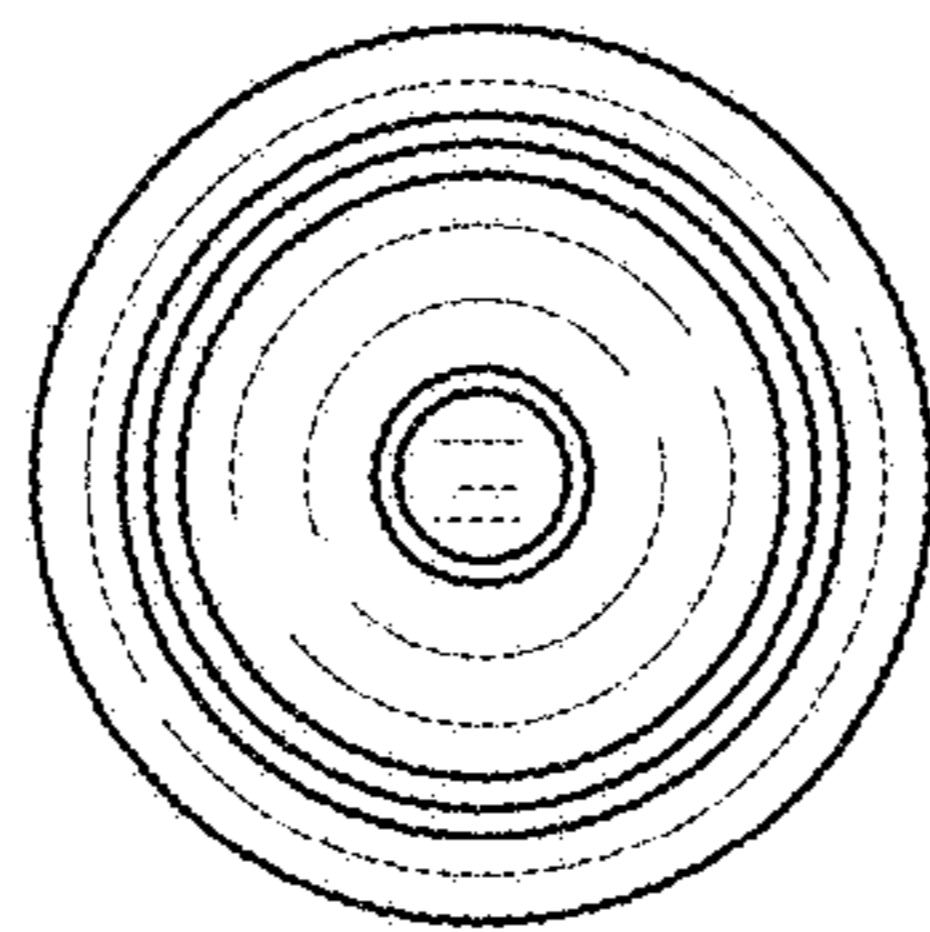

FIG. 5

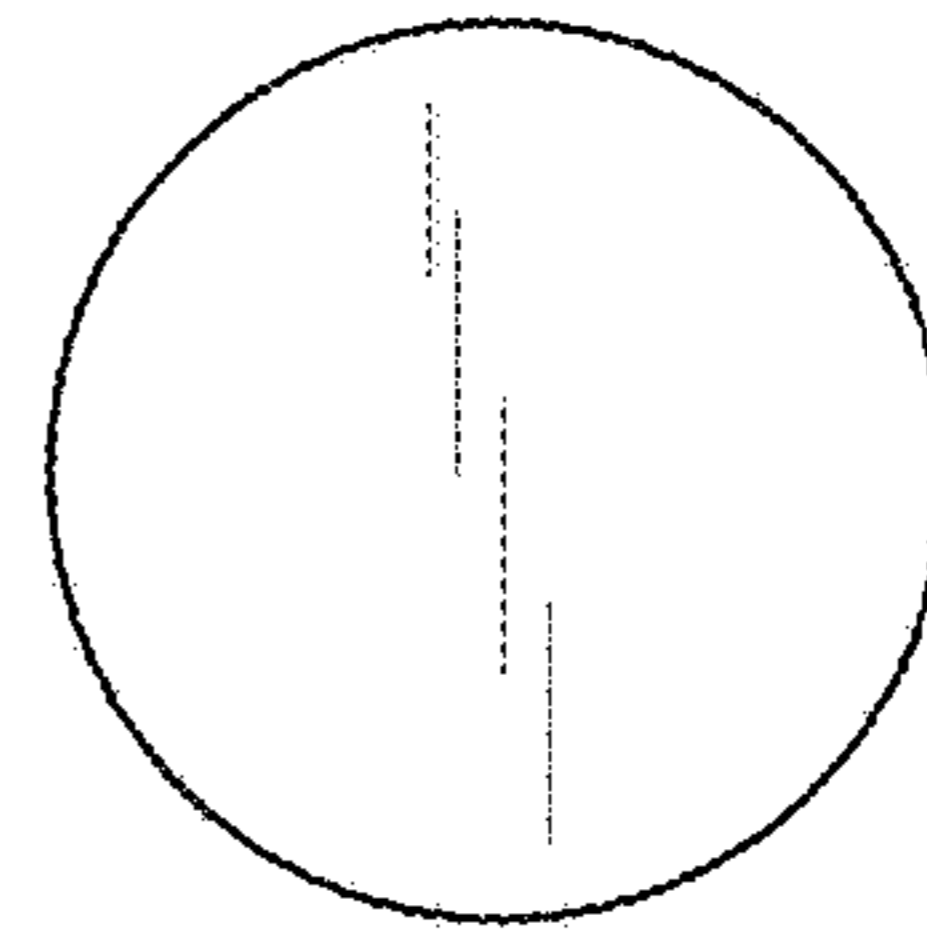

FIG. 6

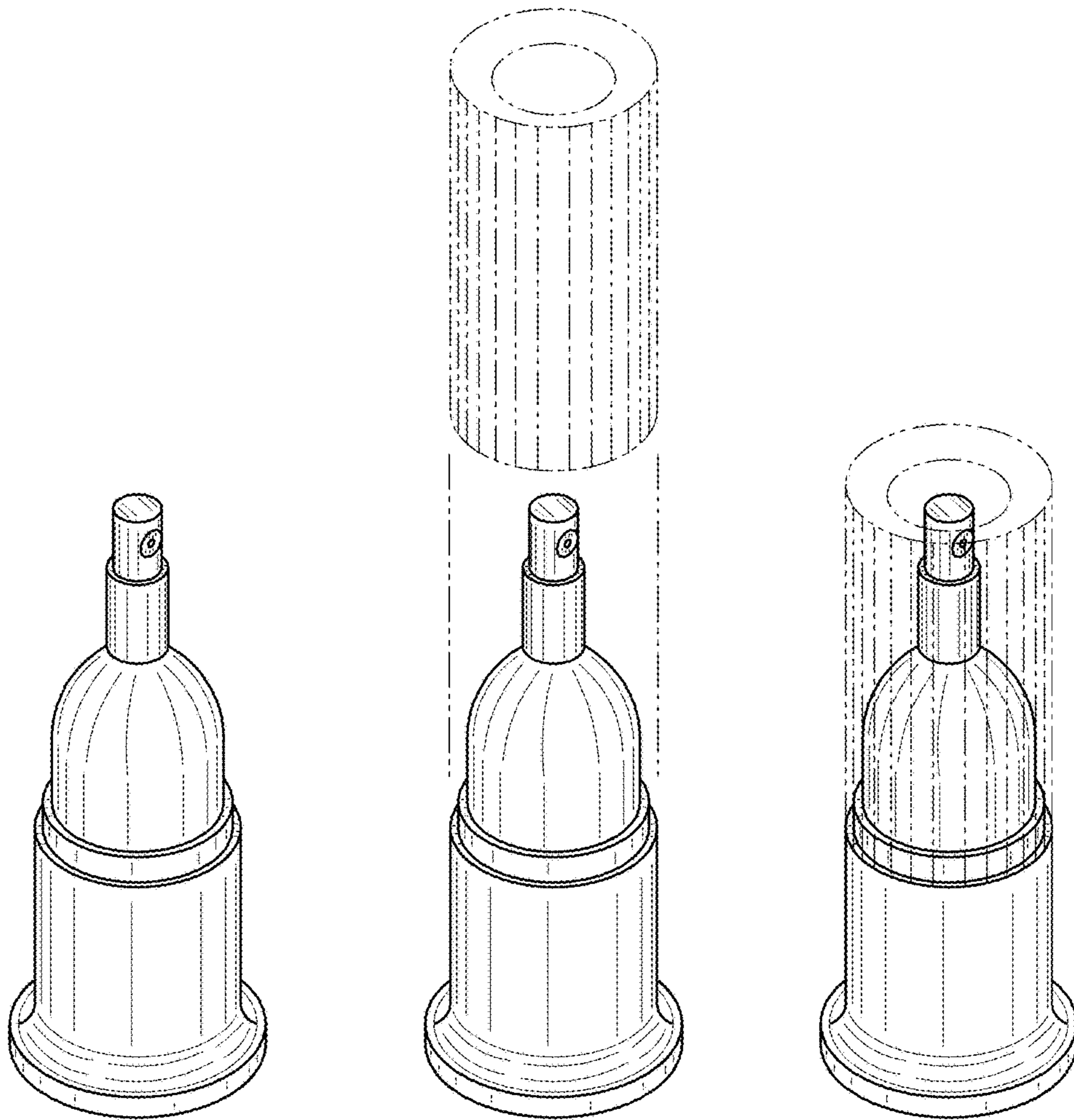

FIG. 7

FIG. 8

FIG. 9

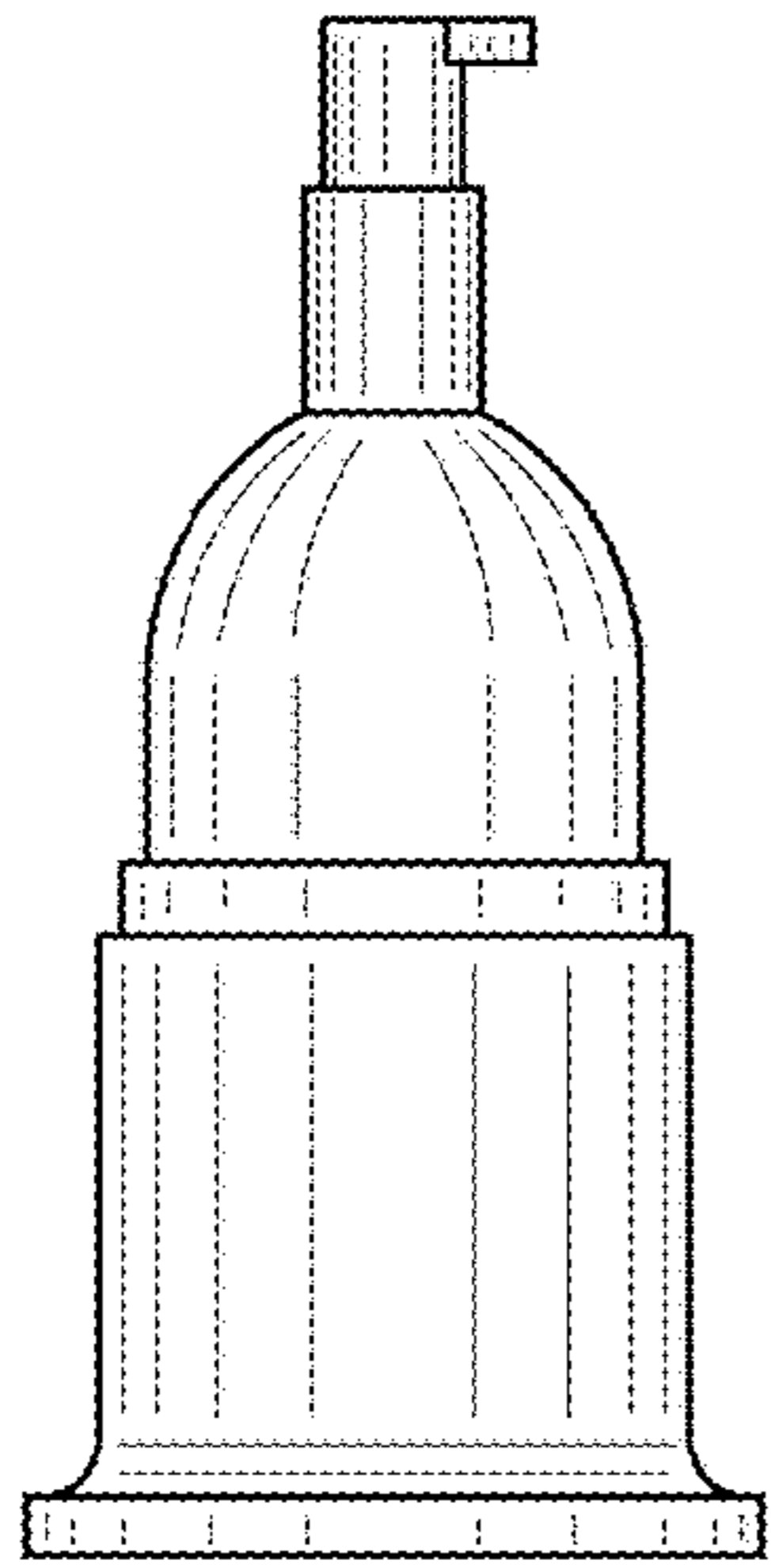

FIG. 10

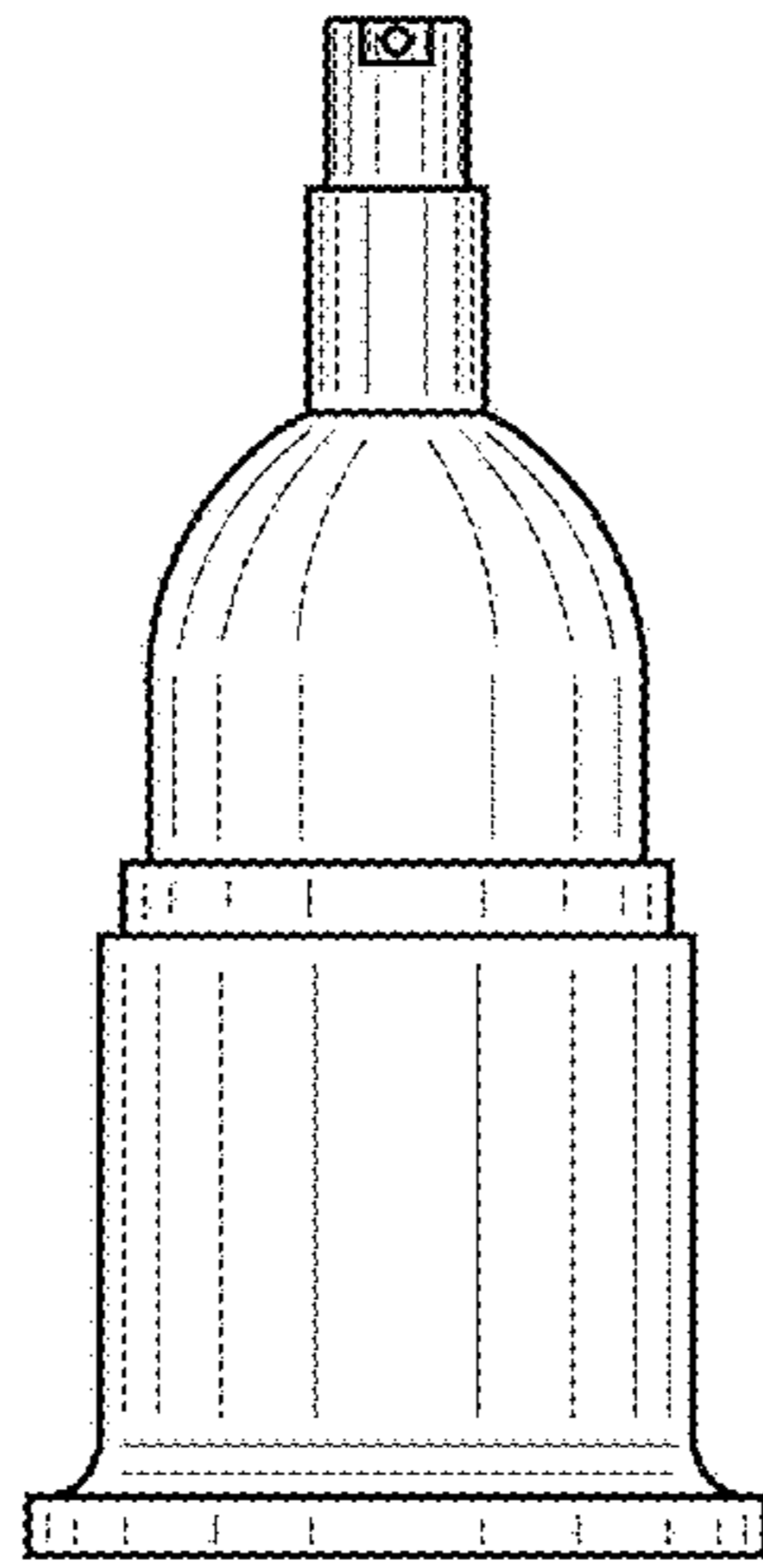

FIG. 11

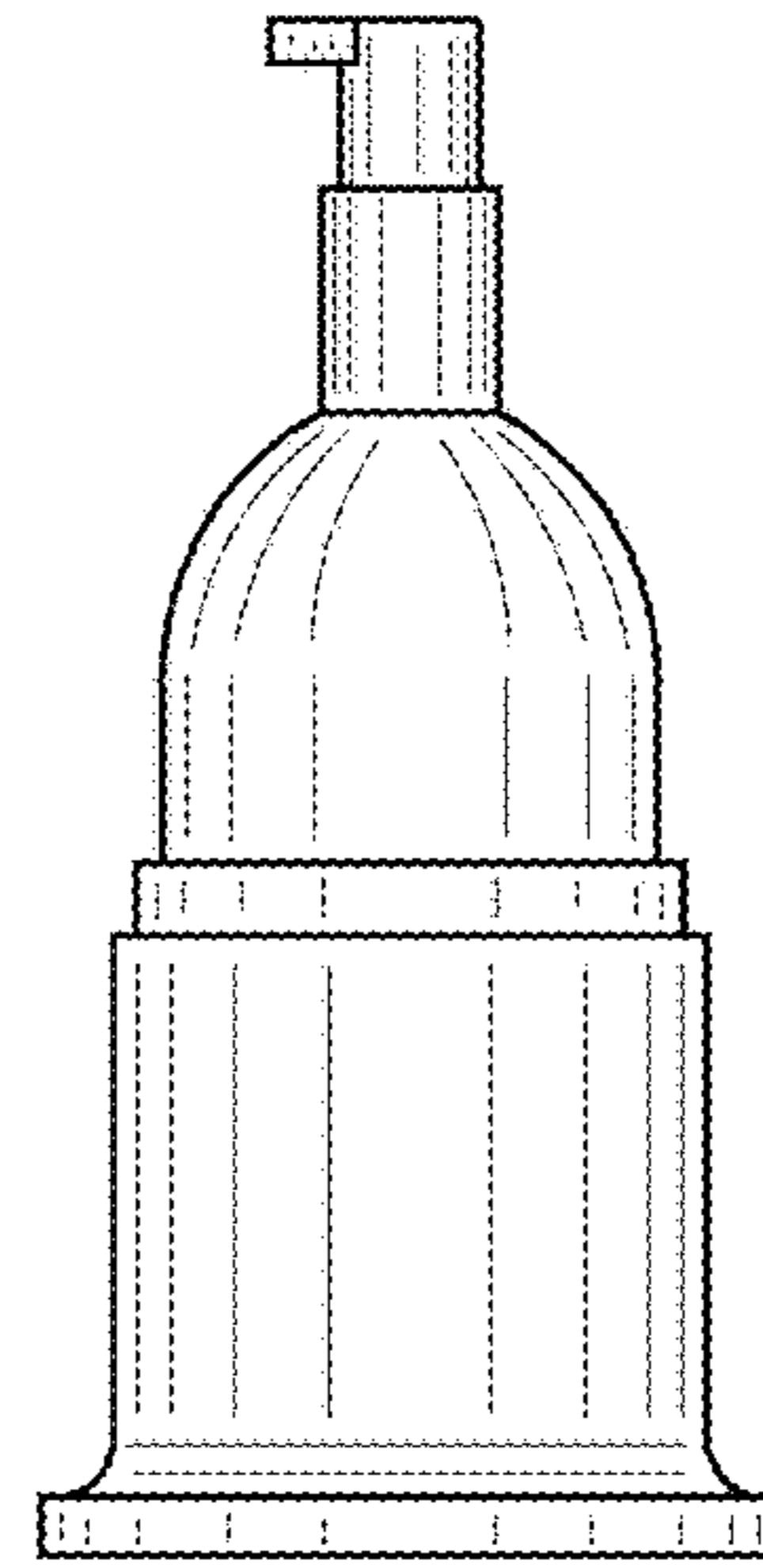

FIG. 12

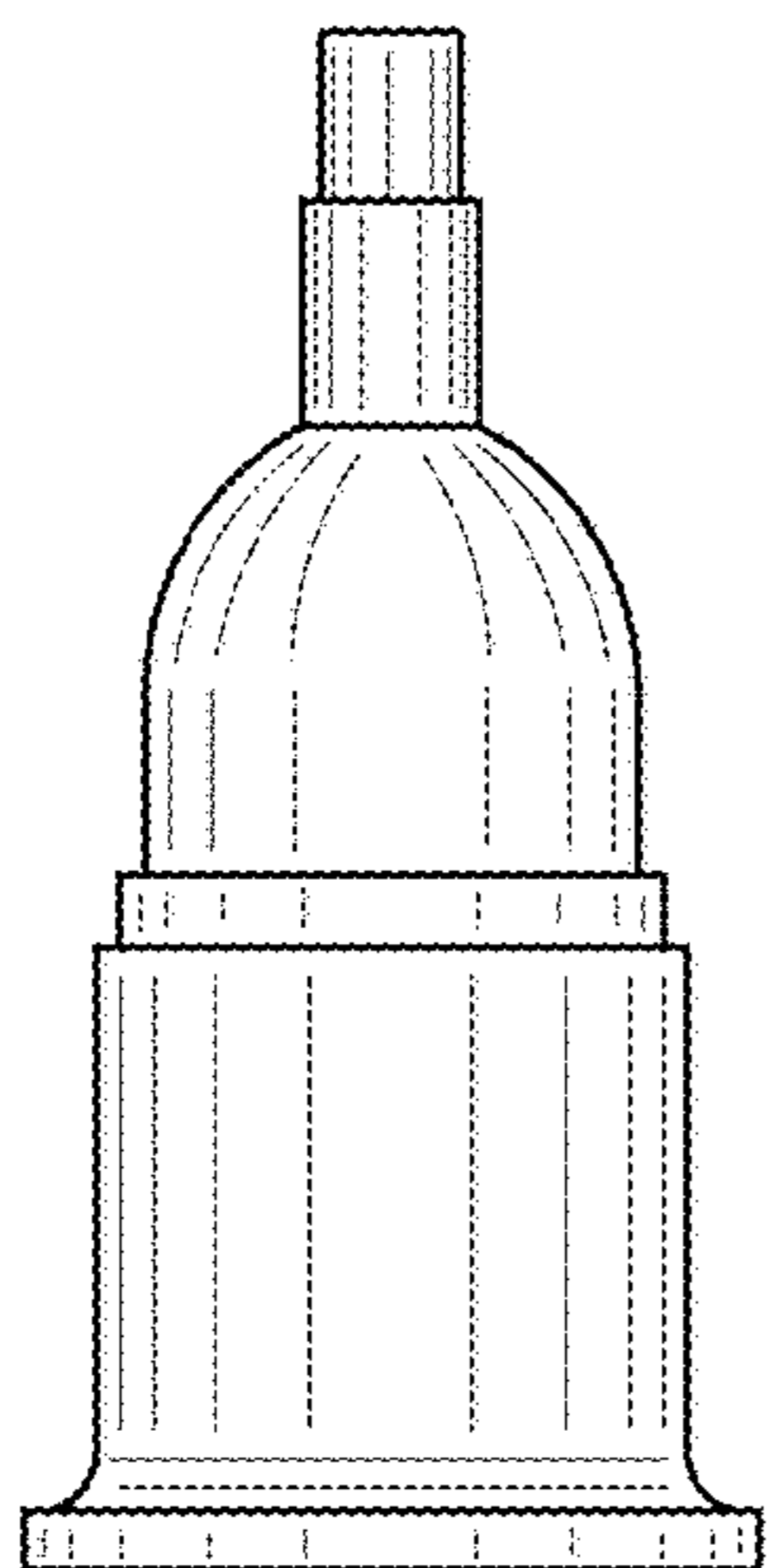

FIG. 13

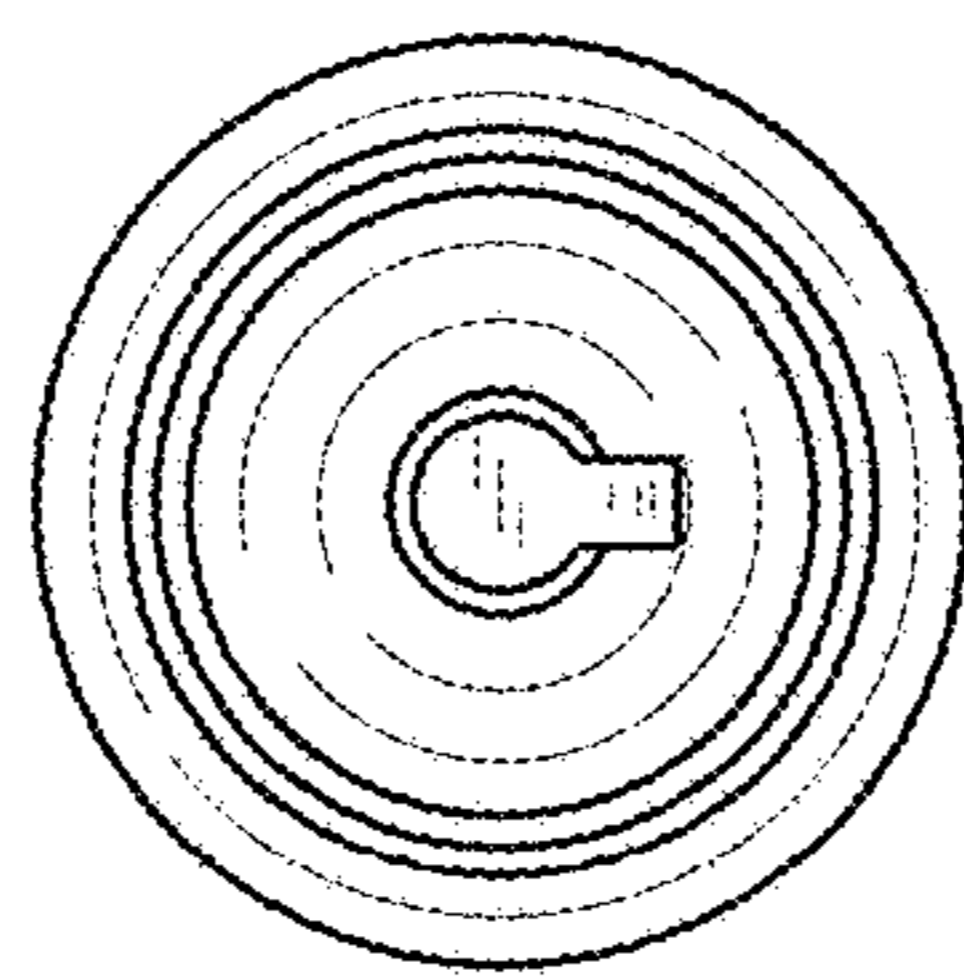

FIG. 14

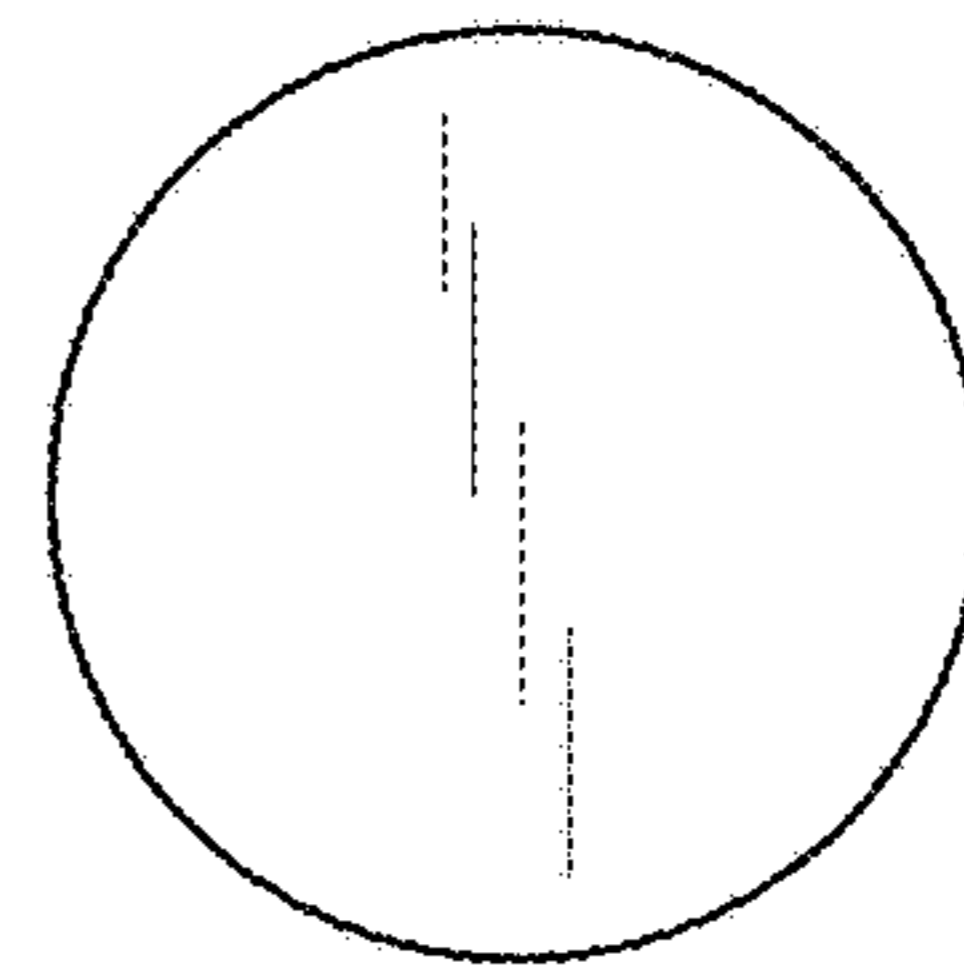

FIG. 15

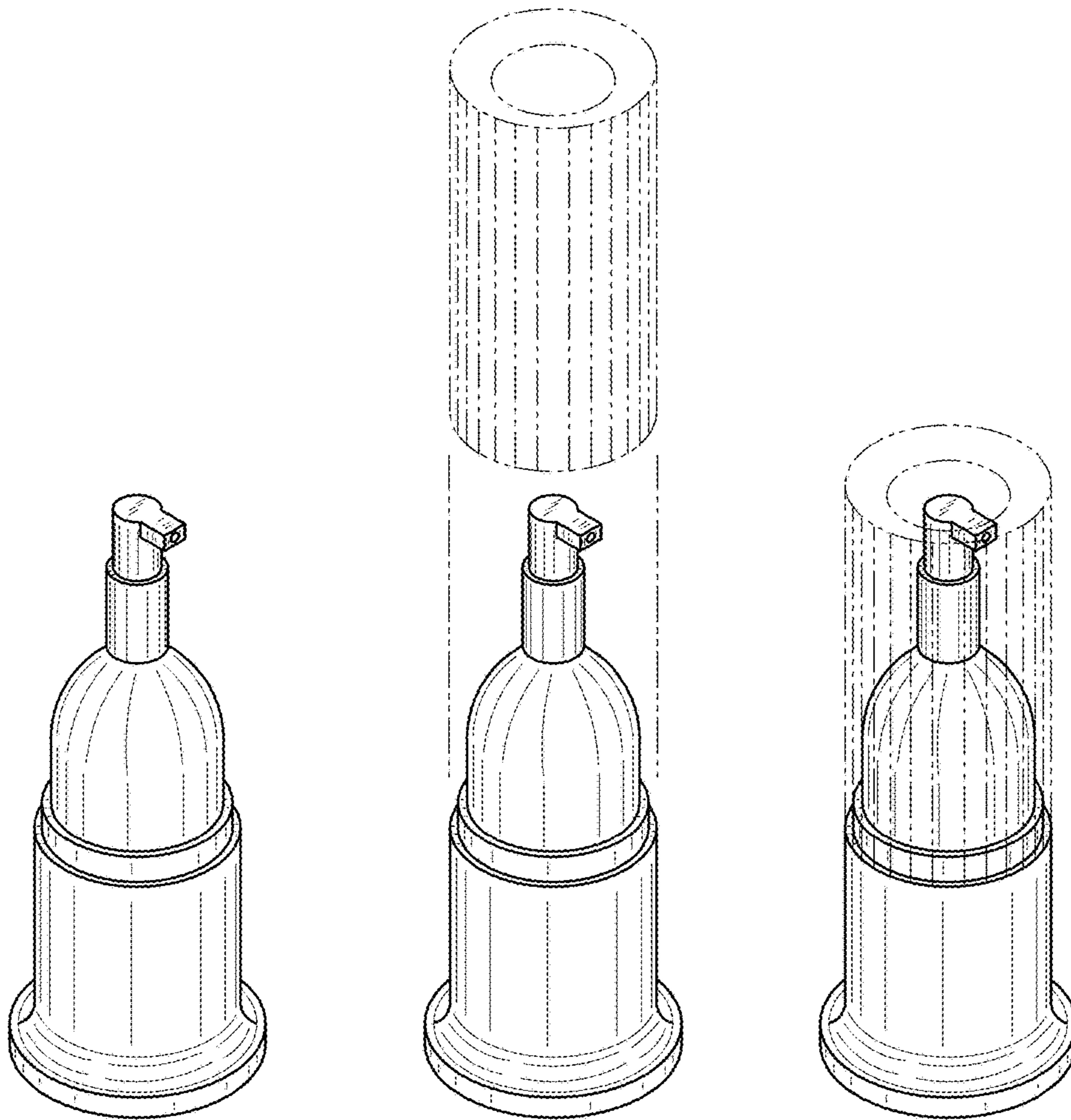

FIG. 16

FIG. 17

FIG. 18