



US00D826059S

(12) **United States Design Patent** (10) **Patent No.:** **US D826,059 S**
Naveau (45) **Date of Patent:** **** Aug. 21, 2018**

(54) **BOTTLE**
(71) Applicant: **SIDEL PARTICIPATIONS**, Octeville sur Mer (FR)
(72) Inventor: **Laurent Naveau**, Octeville sur Mer (FR)
(73) Assignee: **SIDEL PARTICIPATIONS**, Octeville sur Mer (FR)

D567,093 S * 4/2008 Chirico D9/520
D587,582 S * 3/2009 Matsuoka D9/516
D596,948 S * 7/2009 Hackl D9/538
D617,647 S * 6/2010 Bledsoe D9/540
D663,620 S * 7/2012 Lepoitevin D9/516
D731,316 S * 6/2015 Joblonska D9/538
D748,482 S * 2/2016 Darr D9/516
2009/0166314 A1* 7/2009 Matsuoka B65D 1/0223
215/384
2013/0186848 A1* 7/2013 Pasutanon B65D 1/42
215/384
2015/0136727 A1* 5/2015 Hermel B65D 1/0284
215/373

(**) Term: **15 Years**
(21) Appl. No.: **29/570,448**

FOREIGN PATENT DOCUMENTS

CN 303975874 * 12/2016

(22) Filed: **Jul. 8, 2016**

* cited by examiner

(30) **Foreign Application Priority Data**

Mar. 25, 2016 (EM) 003043306-0001

Primary Examiner — Anhdao Doan

Assistant Examiner — Mary Shannon Malley

(51) **LOC (11) Cl.** **09-01**

(74) *Attorney, Agent, or Firm* — Volpe and Koenig, P.C.

(52) **U.S. Cl.**
USPC **D9/549**; D9/551; D9/552; D9/556

(57) **CLAIM**

(58) **Field of Classification Search**
USPC D9/502, 516, 519, 520, 522, 536–543,
D9/557–558, 549–552, 559, 563, 565,
D9/567–571, 574–575, 667, 556, 553;
D24/197; 215/379, 381–384; 220/660,
220/662, 669–673, 675
CPC B65D 1/0223; B65D 2501/0036; B65D
79/005; B65D 23/102; B65D 2501/0027;
B65D 1/0284; B65D 1/44; B65D 23/00;
B65D 1/42
See application file for complete search history.

I claim the ornamental design for a bottle, as shown and described.

DESCRIPTION

FIG. 1 is a bottom perspective view of the bottle of my design;
FIG. 2 is a top perspective view thereof;
FIG. 3 is a second bottom perspective view thereof;
FIG. 4 is a front view thereof, the rear view being identical thereto;
FIG. 5 is a right side view thereof, the left side being identical thereto;
FIG. 6 is a bottom plan view thereof; and,
FIG. 7 is a top plan view thereof.
The broken lines illustrate portions of the bottle that form no part of the claimed design.

(56) **References Cited**

U.S. PATENT DOCUMENTS

5,746,339 A * 5/1998 Petre B65D 1/0292
215/382
D492,201 S * 6/2004 Pritchett D9/537
D523,347 S * 6/2006 Livingston D9/552

1 Claim, 7 Drawing Sheets

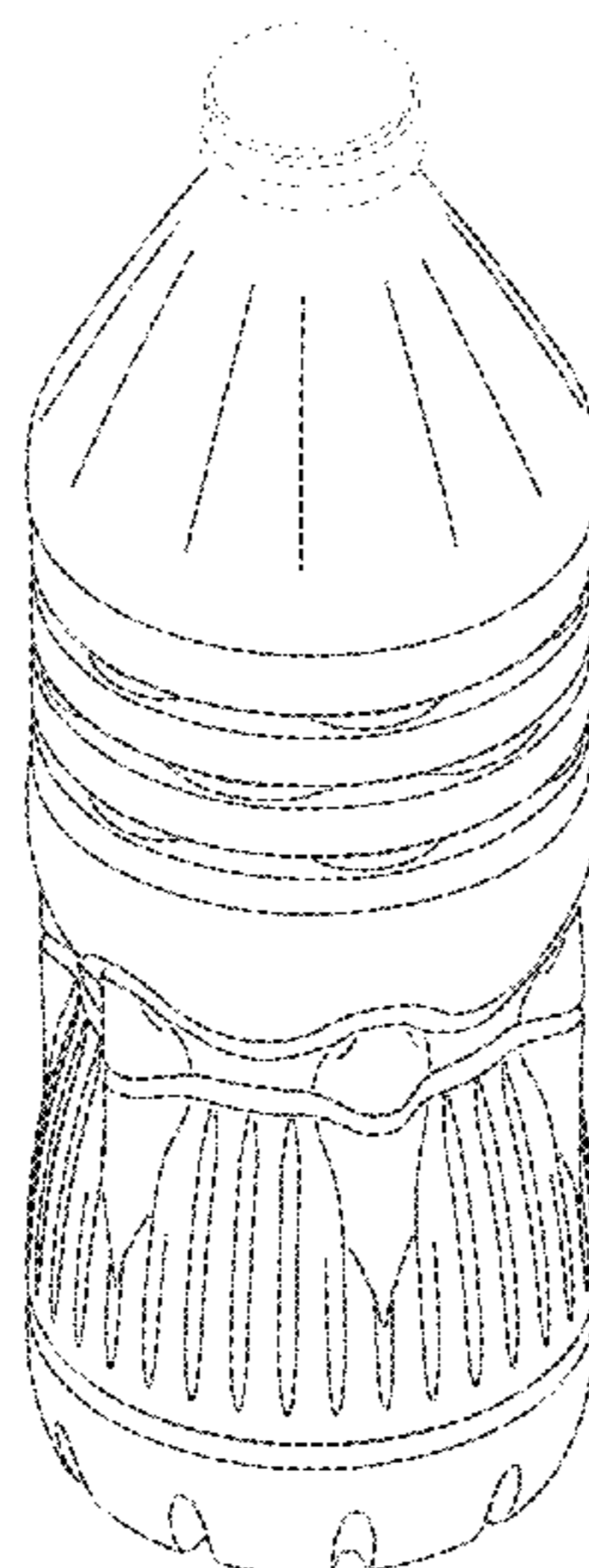

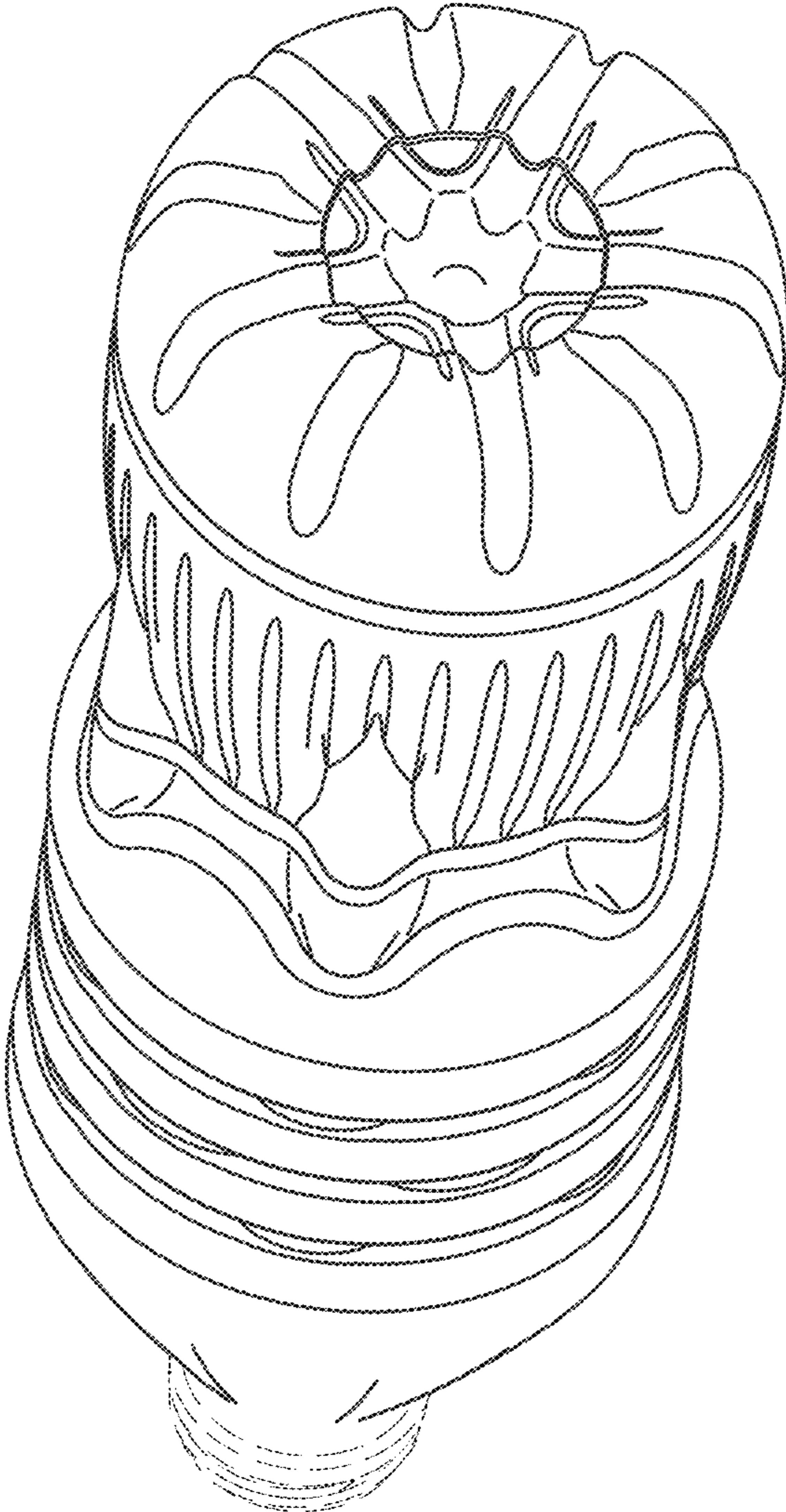

FIG. 1

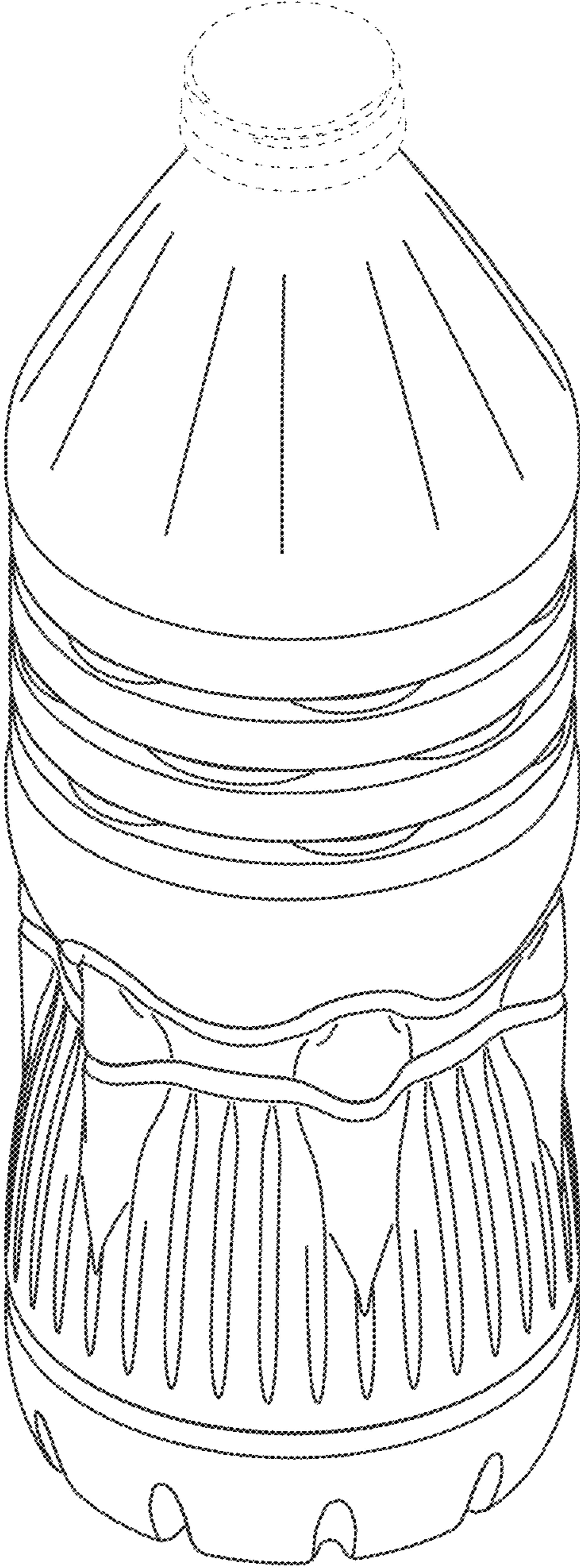

FIG. 2

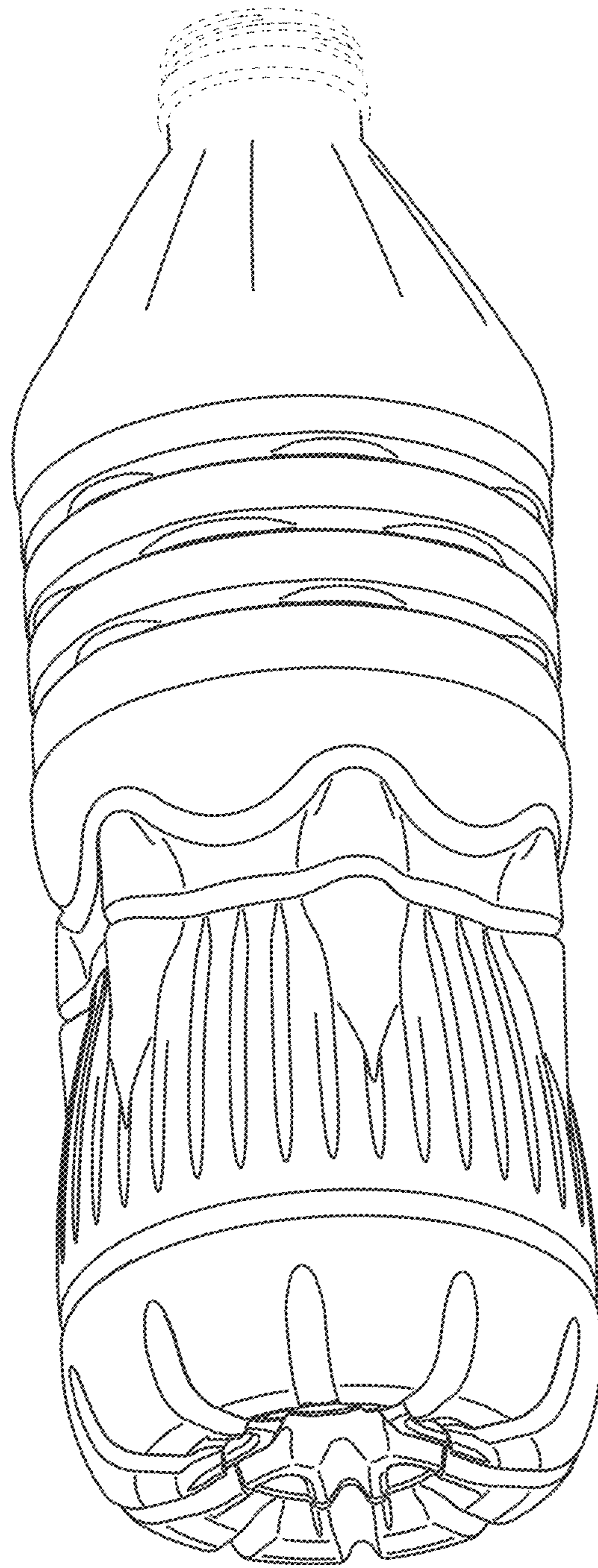

FIG. 3

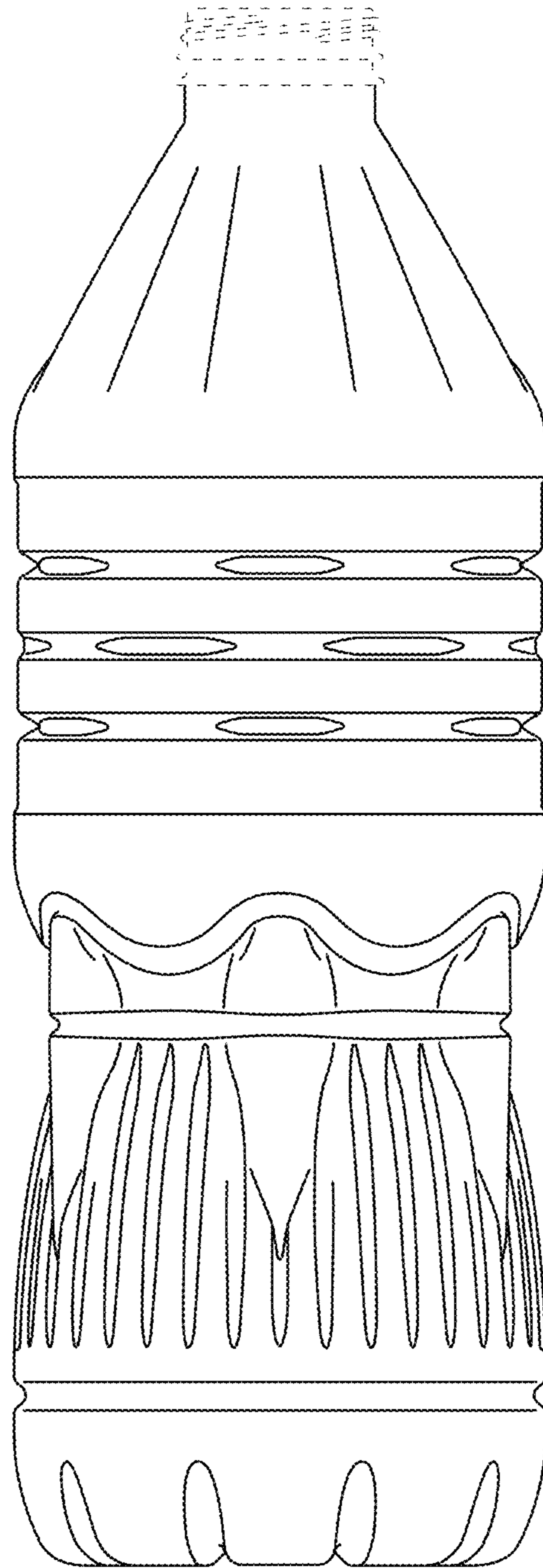

FIG. 4

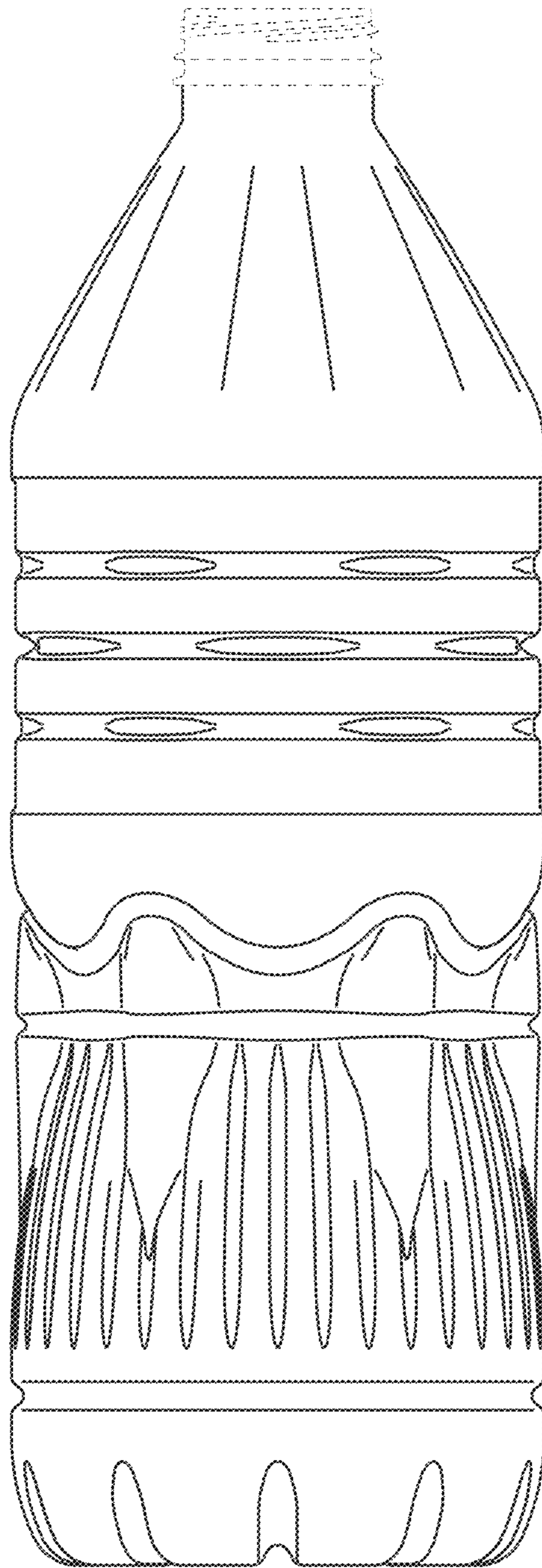

FIG. 5

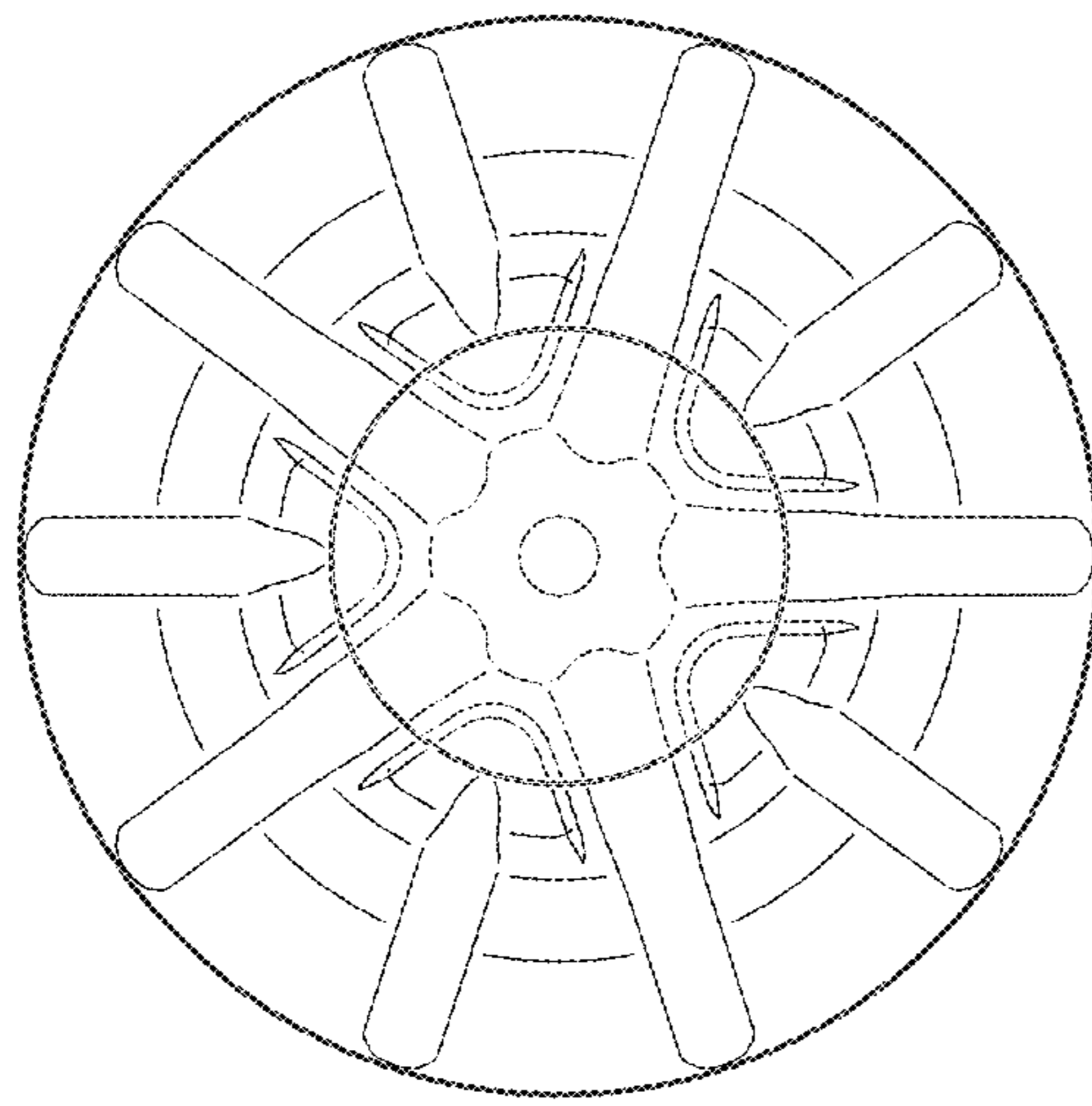

FIG. 6

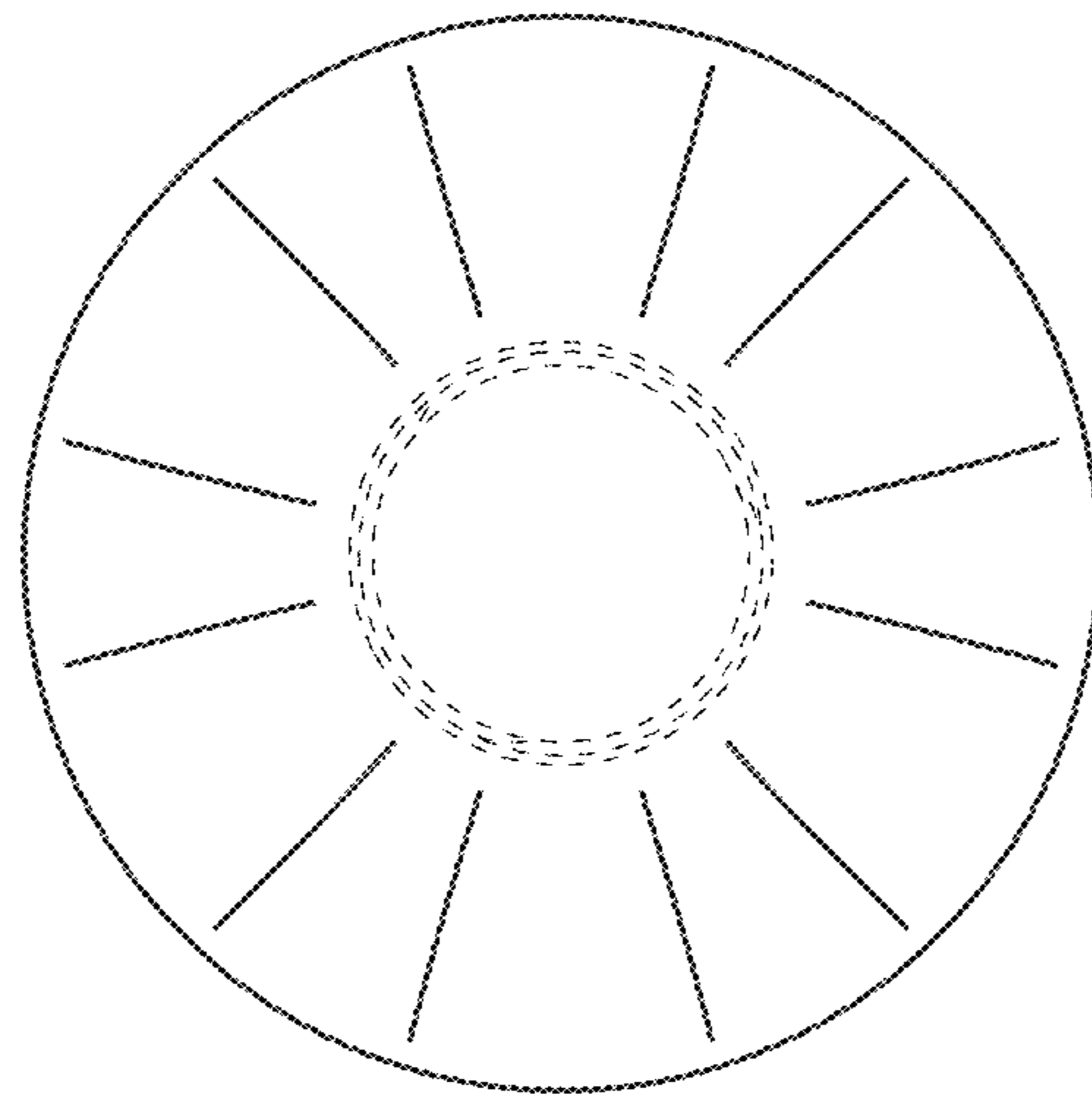

FIG. 7