



US00D825979S

(12) **United States Design Patent** (10) **Patent No.:** **US D825,979 S**
Levy (45) **Date of Patent:** **** Aug. 21, 2018**

(54) **GRILL PAN**
(71) Applicant: **Marvin Levy**, Montvale, NJ (US)
(72) Inventor: **Marvin Levy**, Montvale, NJ (US)
(**) Term: **15 Years**
(21) Appl. No.: **29/582,130**
(22) Filed: **Oct. 25, 2016**
(51) **LOC (11) Cl.** **07-02**
(52) **U.S. Cl.**
USPC **D7/359**
(58) **Field of Classification Search**
USPC D7/323, 332, 335-337, 354-355,
D7/359-364, 387-388, 402, 407-409;
D6/566; D19/90, 92
CPC .. A47J 36/22; A47J 37/00; A47J 37/04; A47J
37/041; A47J 37/042; A47J 37/06; A47J
37/0688; A47J 37/0694; A47J 37/07;
A47J 37/0704; A47J 37/10; A47J
37/1295; A47J 45/071; A47J 45/20; A47J
2037/00; A47J 2037/06; A47J 2037/0611;
A47J 2037/07; A47J 2037/0786; A47J
2037/0795

See application file for complete search history.

(56) **References Cited**

U.S. PATENT DOCUMENTS

1,591,291 A * 7/1926 Detwiler A47J 37/0676
99/446
D154,967 S * 8/1949 Watkins D7/359
D166,780 S * 5/1952 Watkins D7/359
D197,663 S * 3/1964 O'Reilly D7/359
D268,981 S * 5/1983 Monson 426/243
6,252,204 B1 * 6/2001 Po-Hei A47J 37/0676
219/450.1
D463,202 S * 9/2002 Smith D7/359
D508,368 S * 8/2005 Lion D7/388
D538,584 S * 3/2007 Scholze D7/359
D600,070 S * 9/2009 Kellermann D7/409
D618,047 S * 6/2010 Seymour D7/367

D655,804 S * 3/2012 Platt D23/365
D789,147 S * 6/2017 Nilssen D7/409
D793,800 S * 8/2017 Tsai D7/354
2005/0204931 A1 * 9/2005 Cheng A47J 37/108
99/422
2005/0211106 A1 * 9/2005 Dierkes A47J 37/10
99/422

(Continued)

OTHER PUBLICATIONS

Korean Portable BBQ Marble Coating Grill Pan Gas Stove Plate
Pork Beef Roasting, posted at Ebayshopkorea.com, No posting date
given, site visited Aug. 25, 2017, <http://www.ebayshopkorea.com/main/view?itemID=222571103017>.*

(Continued)

Primary Examiner — Barbara Fox
Assistant Examiner — Messina L Smith
(74) *Attorney, Agent, or Firm* — Antonio Papageorgiou,
Esq.; Meister Seelig & Fein LLP

(57) **CLAIM**

The ornamental design for a grill pan, as shown and described.

DESCRIPTION

FIG. 1 is a perspective view of the front, left side, and bottom of a grill pan, showing my new design.
FIG. 2 is another perspective view of the front, left side, and bottom thereof;
FIG. 3 is another perspective view of the front and bottom thereof;
FIG. 4 is a front view thereof;
FIG. 5 is a perspective view of the rear, right side, and top thereof; and,
FIG. 6 is another perspective view of the rear, right side, and top thereof.
The broken lines in the drawings depict portions of the grill pan that form no part of the claimed design.

1 Claim, 6 Drawing Sheets

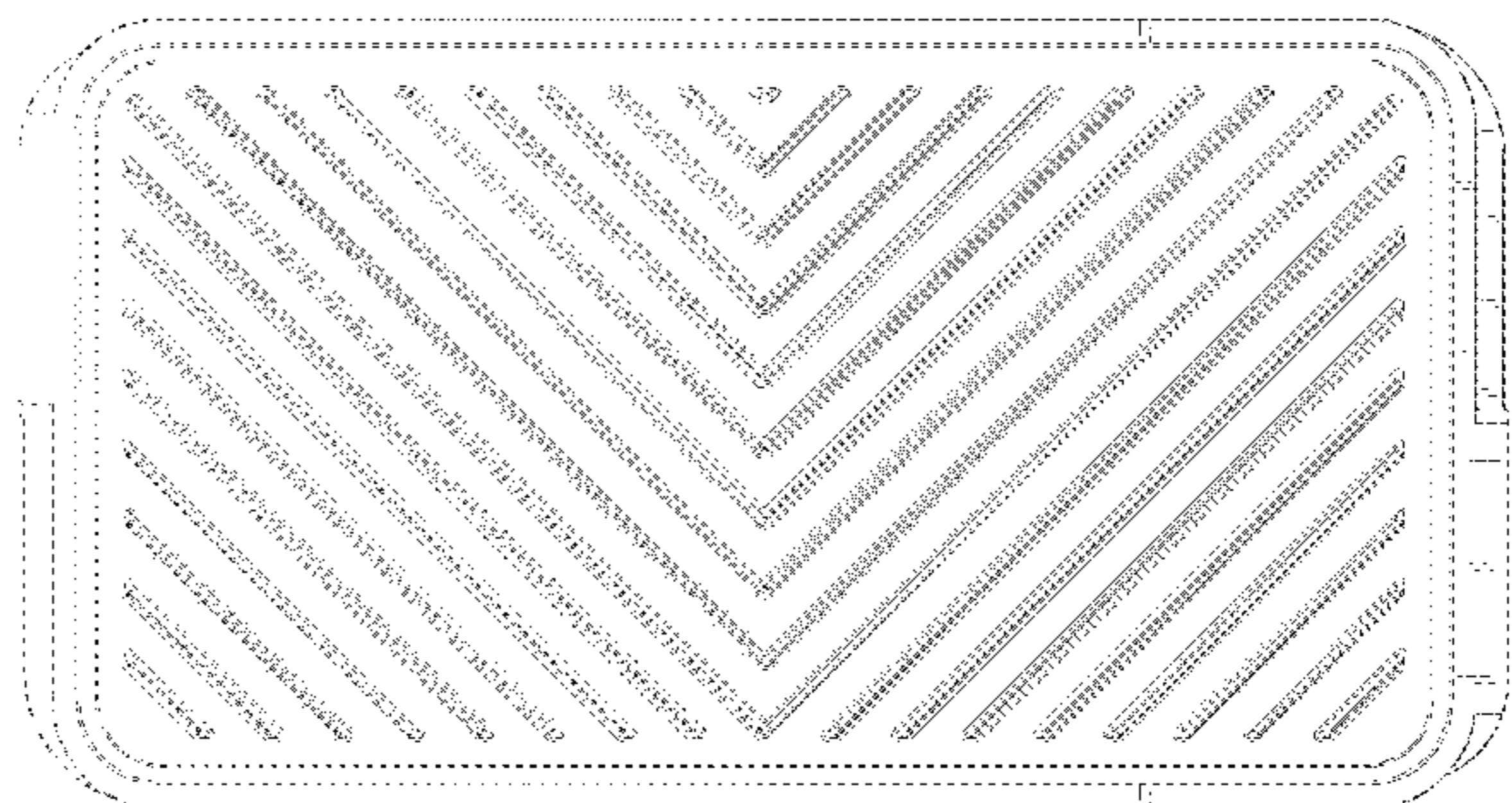
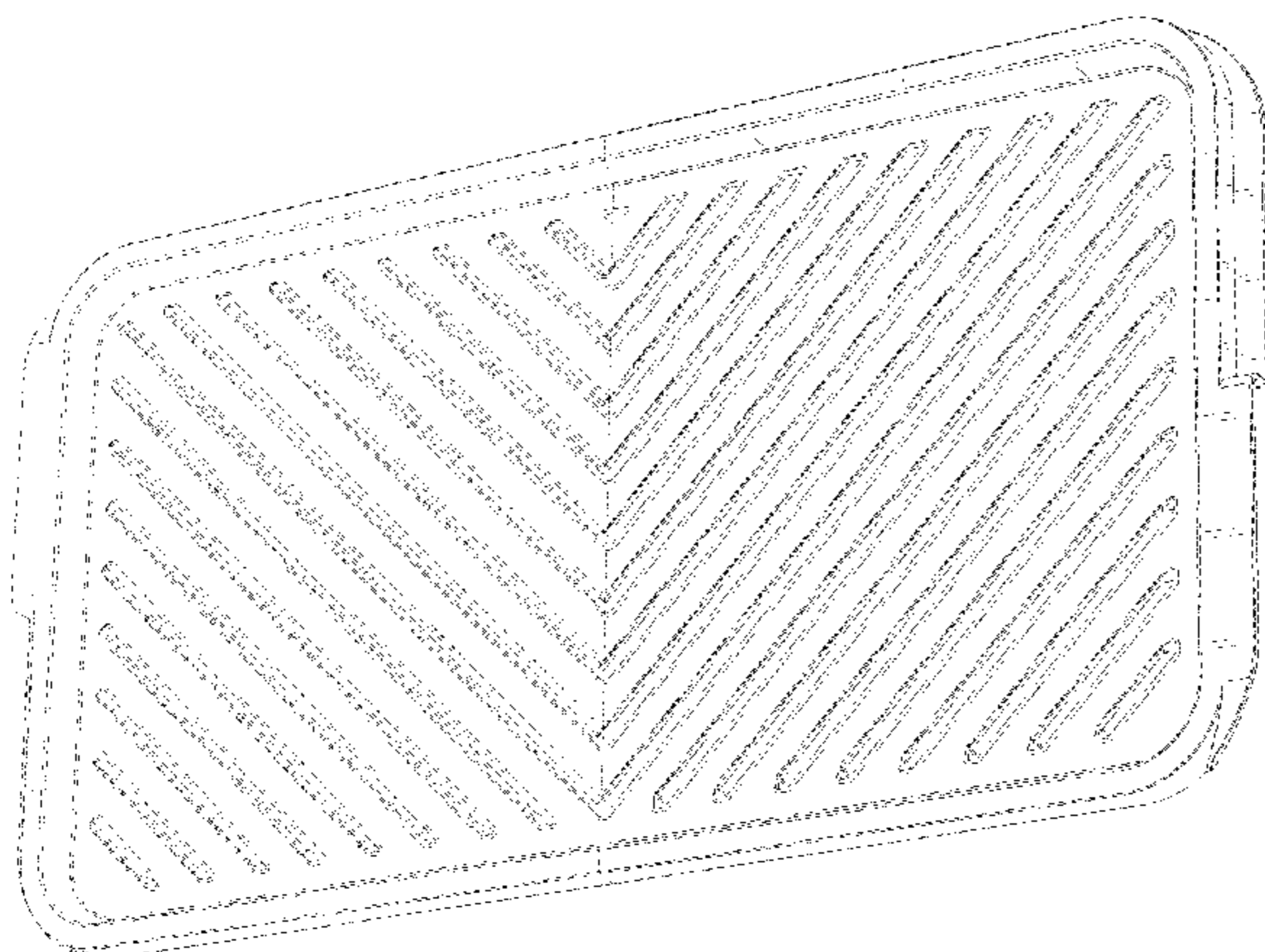

(56)

References Cited

U.S. PATENT DOCUMENTS

2006/0180138 A1* 8/2006 Lin A47J 37/0611
126/25 R
2016/0120363 A1* 5/2016 Zwanenburg A47J 37/108
426/523

OTHER PUBLICATIONS

Todd English Hard Anodized by Greenpan Grill 'N' Griddle Gourmet Pan, posted at Guide.alibaba.com, posted on © 1999-2017, site visited Aug. 25, 2017, <https://guide.alibaba.com/shopping-guides/grill-griddle-pan.html>.*

Scanpan Mixed Grill & Griddle Pan, posted at Surlatable.com, posted on Aug. 20, 2013, site visited Aug. 25, 2017, https://www.surlatable.com/product/PRO-889063/?affsrcid=AFF0005&utm_source=Google&utm_medium=cpc&utm_campaign=206387981&utm_term=105474114581_product_type_cookware_product_type_grill_pans_%26_griddles_cu.*

* cited by examiner

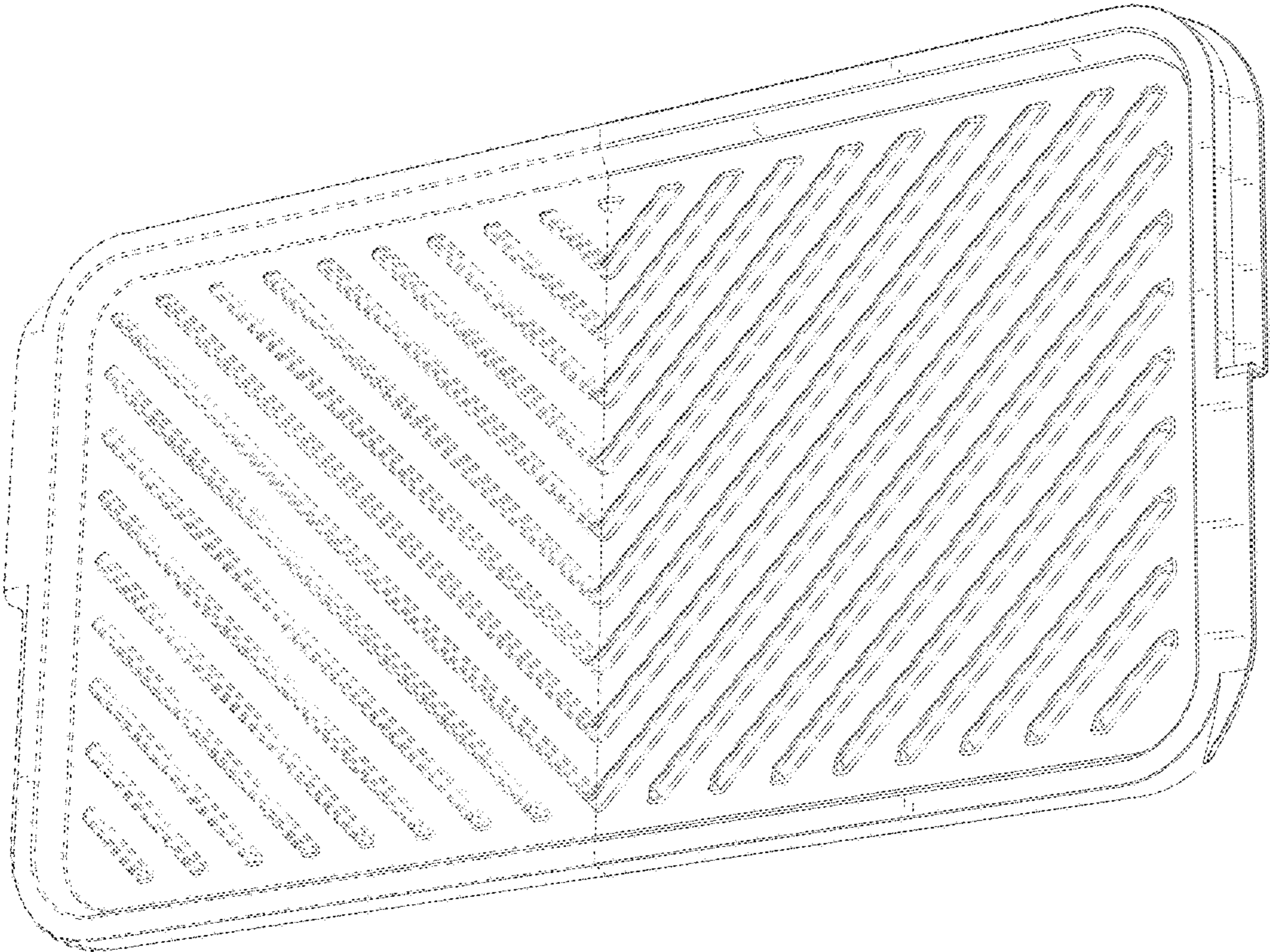

FIG. 1

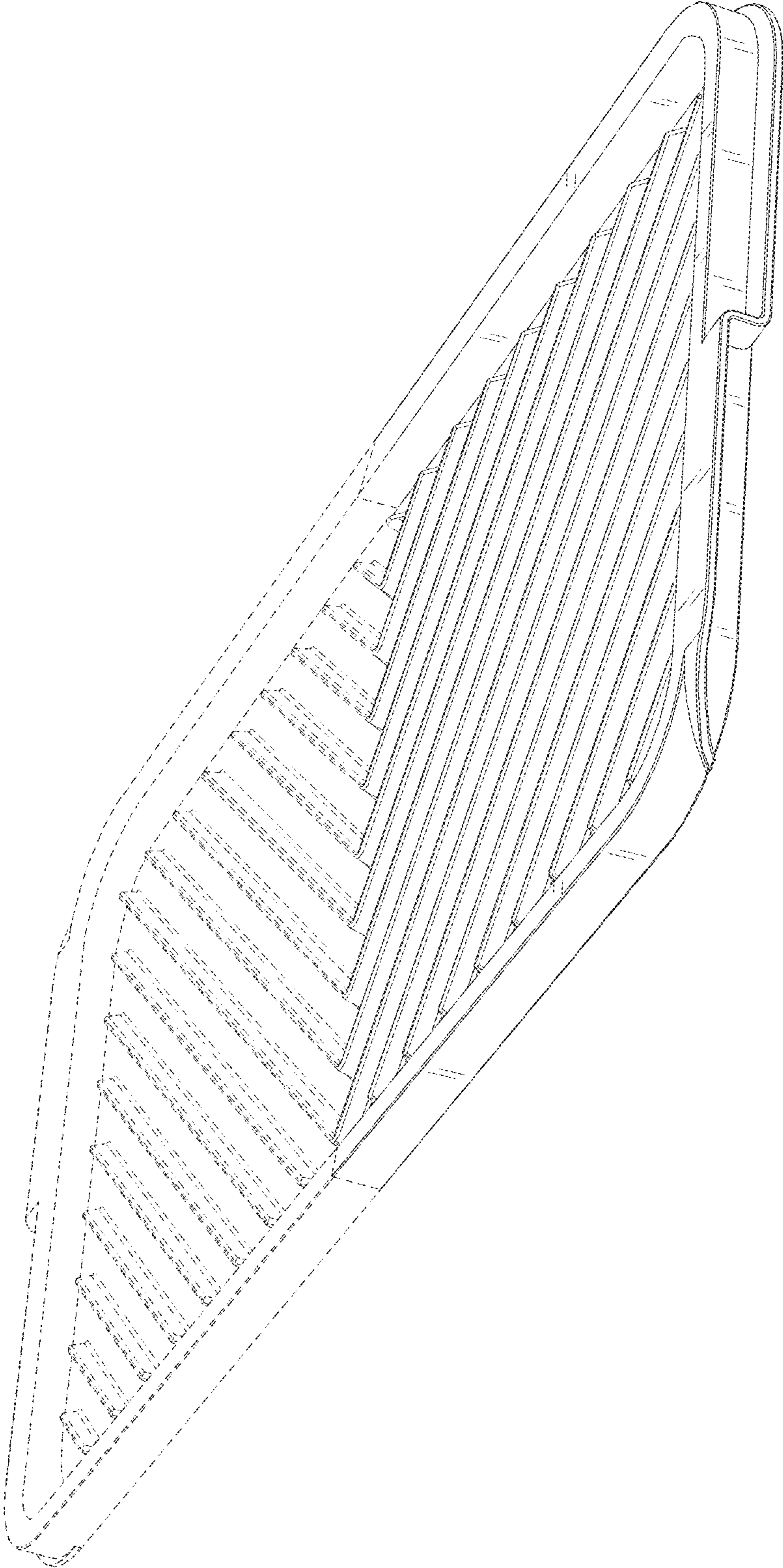

FIG. 2

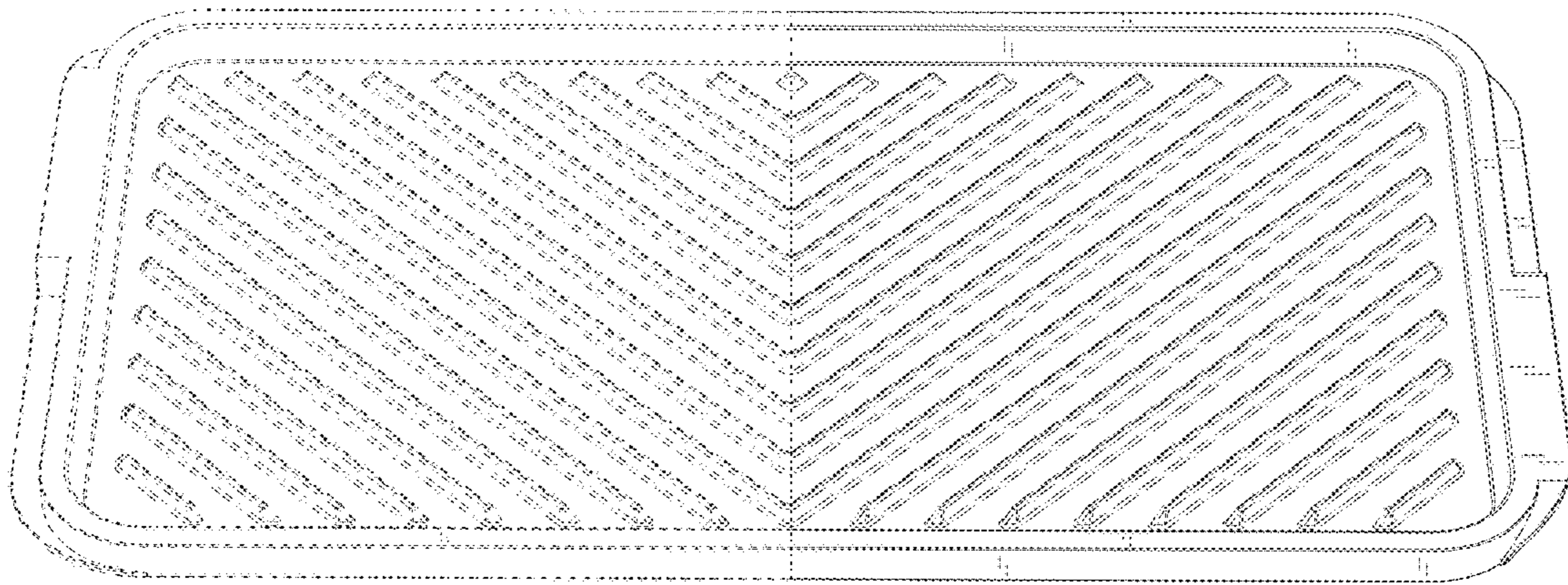

FIG. 3

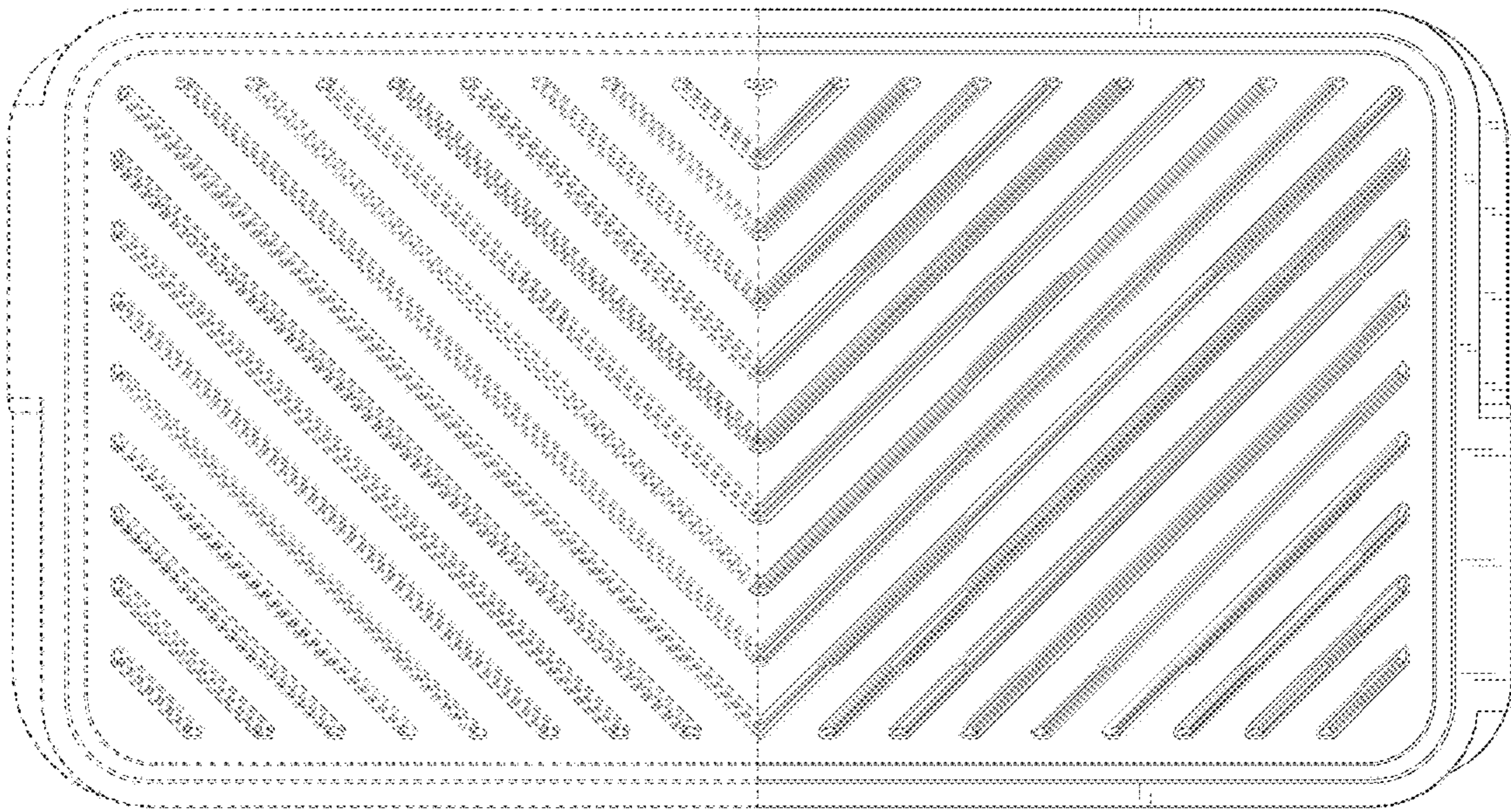

FIG. 4

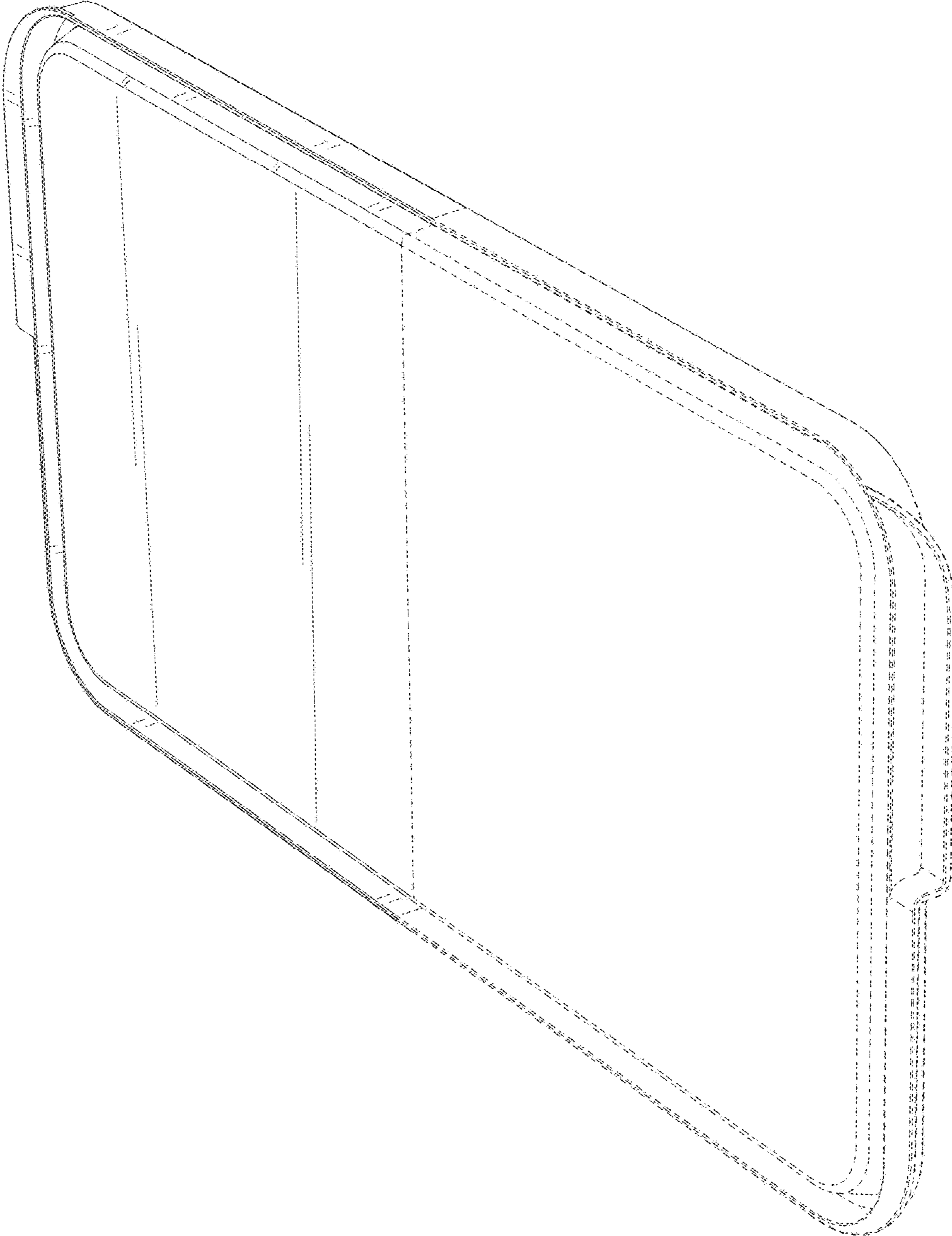

FIG. 5



FIG. 6