

US00D825924S

(12) **United States Design Patent**  
**Tuang**

(10) **Patent No.:** **US D825,924 S**

(45) **Date of Patent:** **\*\* Aug. 21, 2018**

(54) **STACKABLE DRAWER WITH A STAND**

D796,259 S \* 9/2017 McGrath ..... D7/354  
D799,897 S \* 10/2017 McGrath ..... D7/409  
D814,190 S \* 4/2018 Mishan ..... D3/306

(71) Applicant: **EP Family Corp.**, Walnut, CA (US)

(Continued)

(72) Inventor: **Bao-Yi Tuang**, Walnut, CA (US)

*Primary Examiner* — Kelley Donnelly

(\*\*) Term: **15 Years**

(74) *Attorney, Agent, or Firm* — Tommy S F Wang;  
Wang IP Law Group, P.C.

(21) Appl. No.: **29/619,123**

(22) Filed: **Sep. 27, 2017**

(57) **CLAIM**

(51) **LOC (11) Cl.** ..... **03-01**

The ornamental design for a stackable drawer with a stand,  
as shown and described.

(52) **U.S. Cl.**

USPC ..... **D3/306**

(58) **Field of Classification Search**

**DESCRIPTION**

USPC ..... D3/304, 306, 307, 308, 309, 315;  
D6/672, 675, 675.5, 681, 683; D7/550.1,  
D7/552.1, 553.2, 554.3, 601, 602, 402,  
D7/409, 412

CPC ..... A47J 27/002; A47J 37/00; A47J 37/04;  
A47J 37/041; A47J 37/042; B65D 7/00;  
B65D 7/14; B65D 7/20; B65D 7/42

See application file for complete search history.

FIG. 1 is a perspective view of a stackable drawer with a stand showing my new design;  
FIG. 2 is a front view thereof;  
FIG. 3 is a rear view thereof;  
FIG. 4 is a left side view thereof;  
FIG. 5 is a right side view thereof;  
FIG. 6 is a top view thereof;  
FIG. 7 is a bottom view thereof;  
FIG. 8 is an enlarged view of an indicated portion of FIG. 1;

(56) **References Cited**

**U.S. PATENT DOCUMENTS**

D373,039 S \* 8/1996 Cohen ..... D6/566  
D395,548 S \* 6/1998 Morissette ..... D3/304  
D416,165 S \* 11/1999 Zemel ..... D7/354  
6,213,005 B1 \* 4/2001 Sherman ..... A47J 27/002  
220/573.1  
D639,603 S \* 6/2011 Degnan ..... D7/354  
D640,501 S \* 6/2011 Zemel ..... D7/354  
D653,497 S \* 2/2012 Cloutier ..... D7/354  
8,141,737 B1 \* 3/2012 Tsai ..... B65D 7/14  
220/485  
D658,427 S \* 5/2012 Cloutier ..... D7/360  
D679,130 S \* 4/2013 Cloutier ..... D7/354  
D689,946 S \* 9/2013 Hu ..... D19/92  
D692,668 S \* 11/2013 Hu ..... D3/306  
D758,732 S \* 6/2016 Goodman ..... D3/306  
D786,009 S \* 5/2017 Mirchandani ..... D7/354

FIG. 9 is another perspective view of an additional arrangement of stackable drawer and a stand, drawn in broken lines;  
FIG. 10 is another right side view of the additional arrangement of stackable drawer and the stand, drawn in broken lines; and,  
FIG. 11 is another enlarged view of an indicated portion of FIG. 10, showing that one corner of the stand is fixed with the stackable drawer by a fastener of the stand, and another corner is not fixed by the fastener.

The broken lines of the additional arrangement of the stackable drawer and the stand in FIGS. 9-11 illustrate unclaimed environment and forms no part of the claimed design.

**1 Claim, 9 Drawing Sheets**

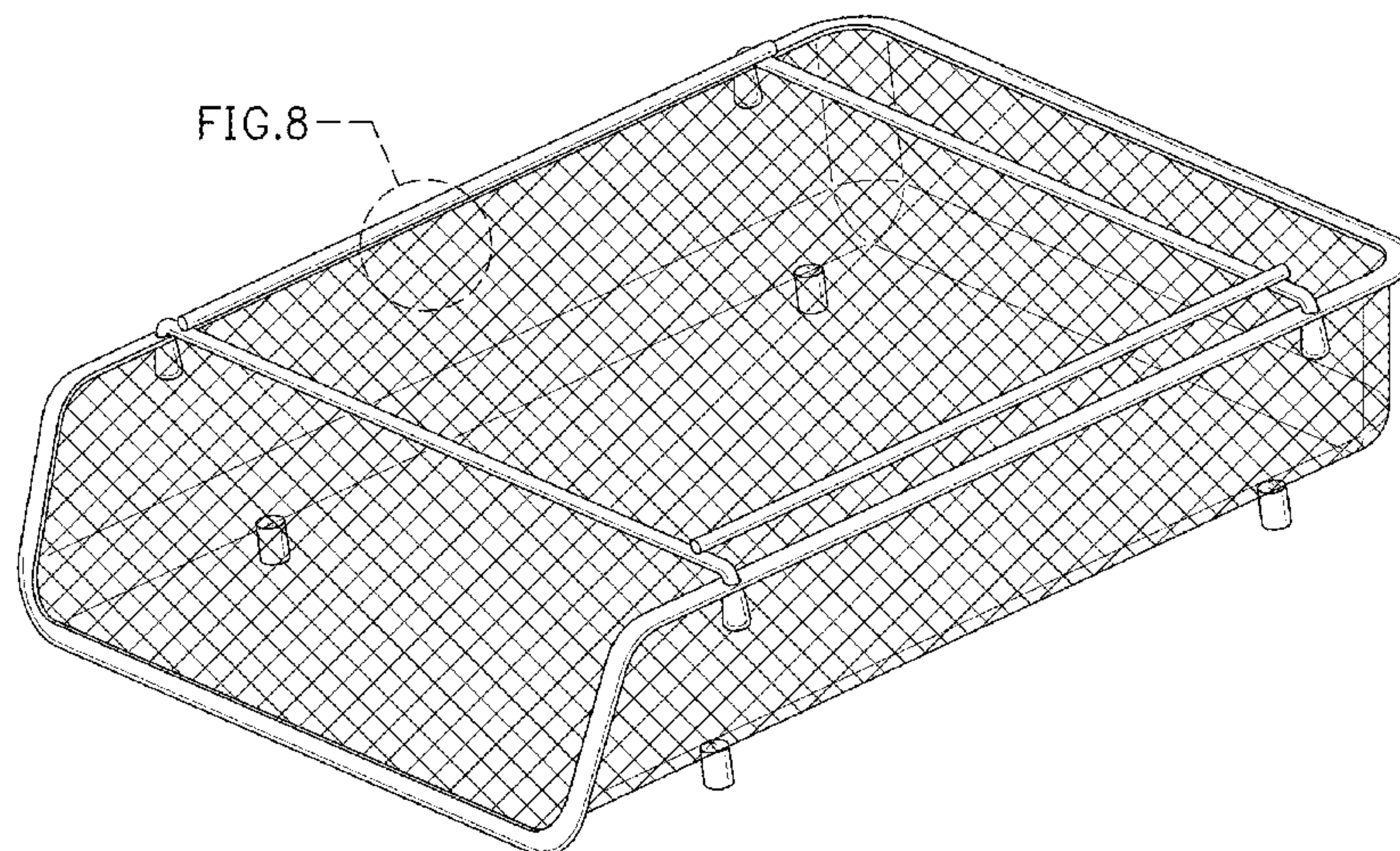

(56)

**References Cited**

U.S. PATENT DOCUMENTS

2008/0124438 A1\* 5/2008 Forte ..... A47J 37/1295  
426/389  
2013/0233183 A1\* 9/2013 Brinckerhoff ..... A47J 37/1295  
99/403

\* cited by examiner



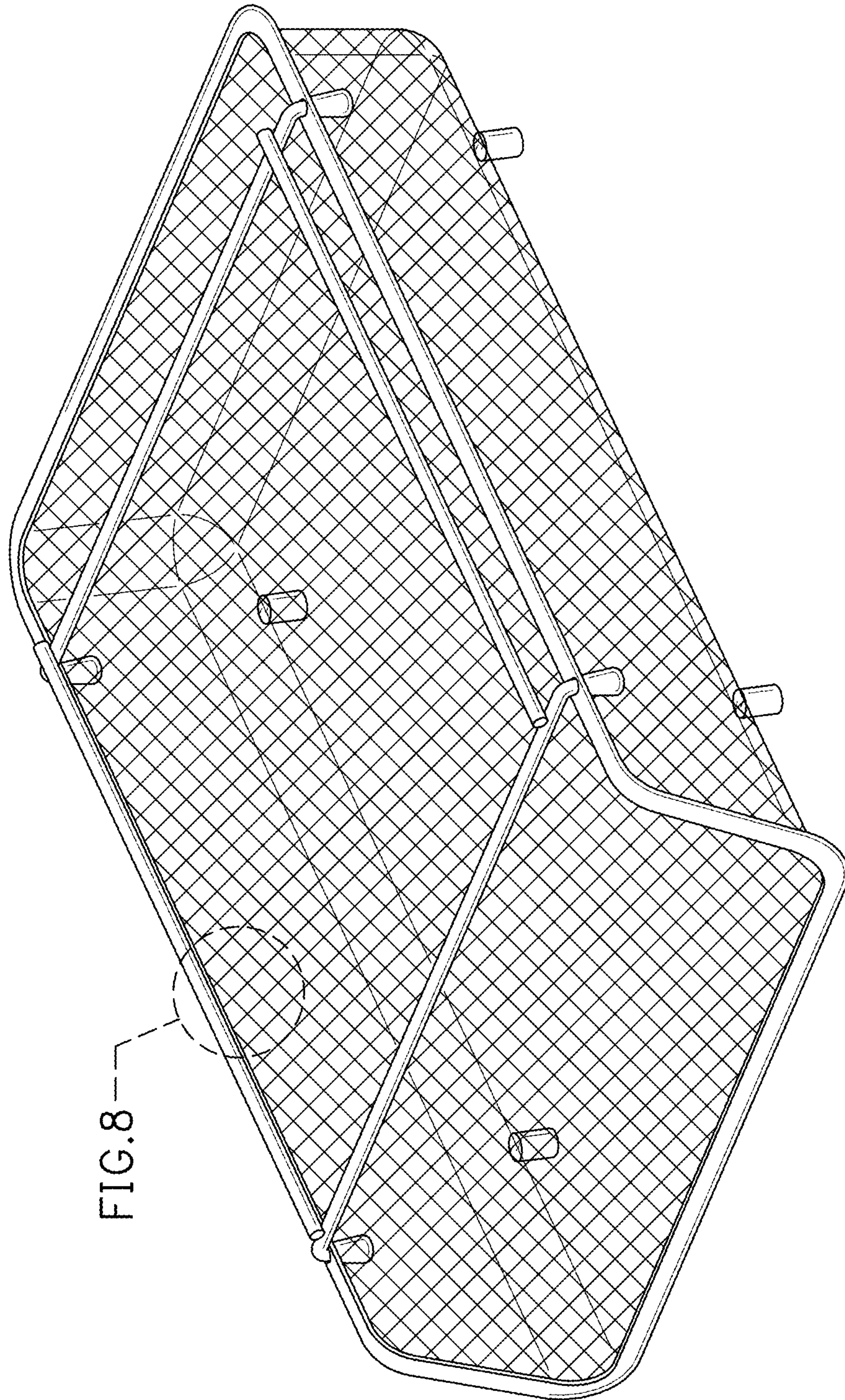

FIG. 8

FIG. 1



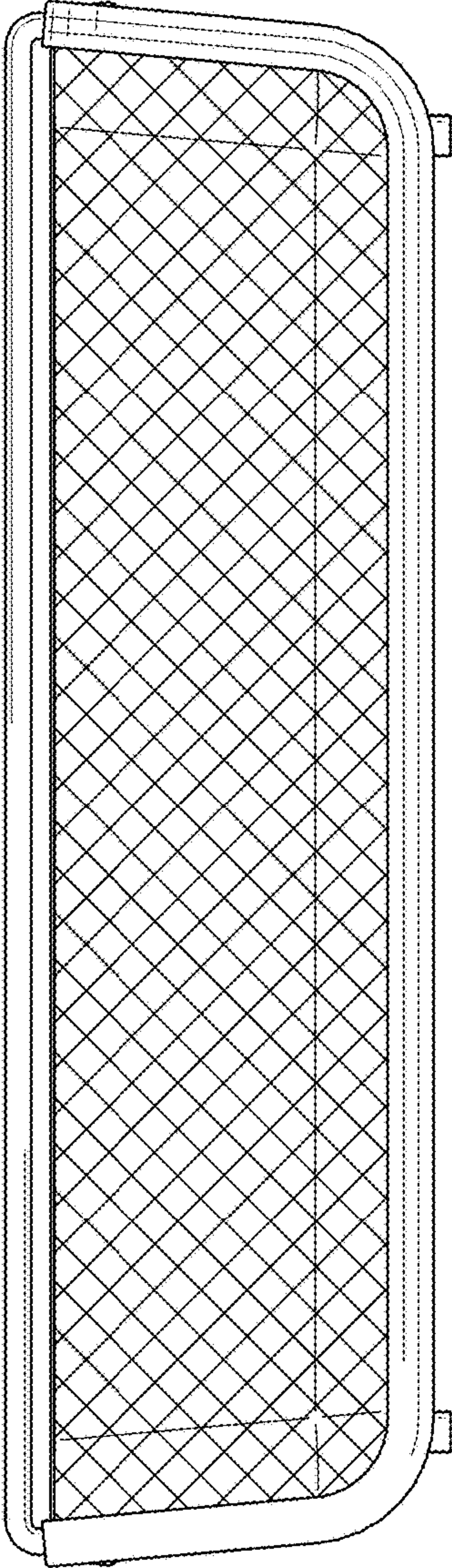

FIG. 2

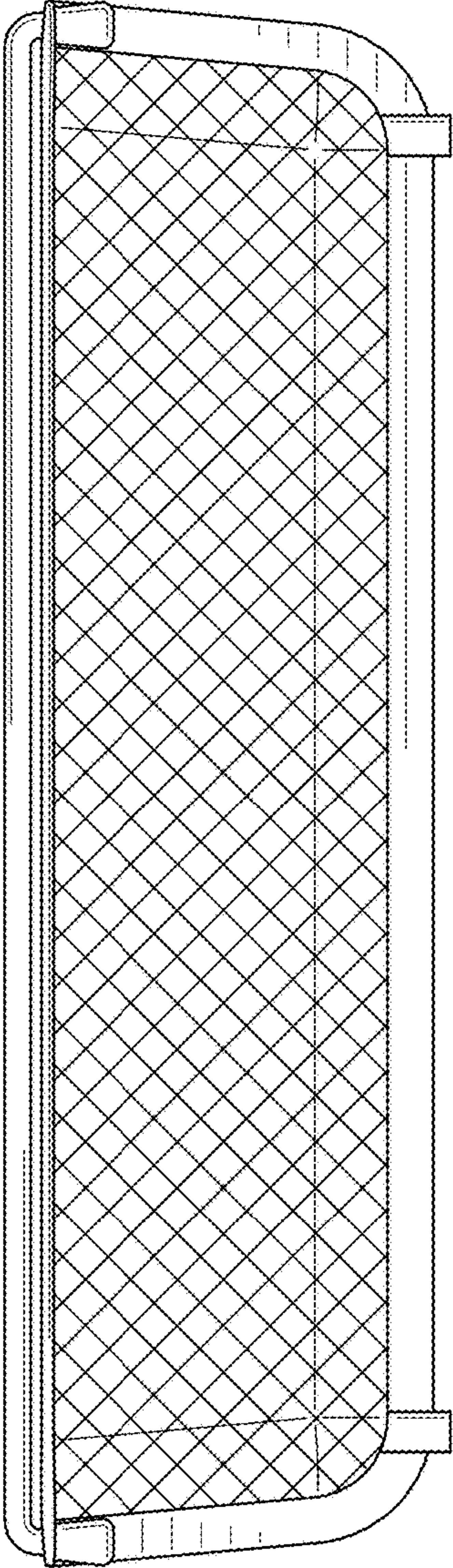

FIG. 3



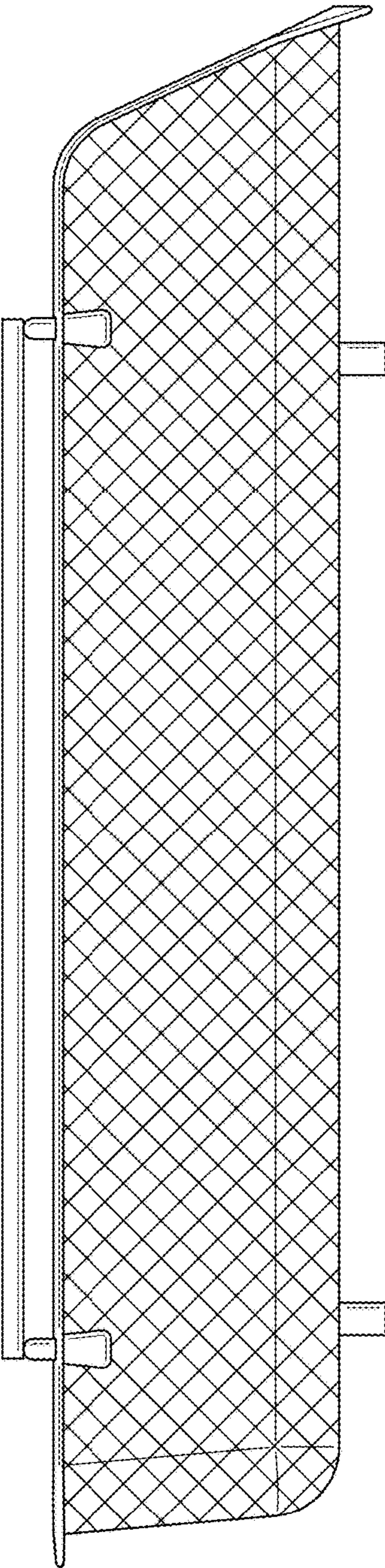

FIG. 4

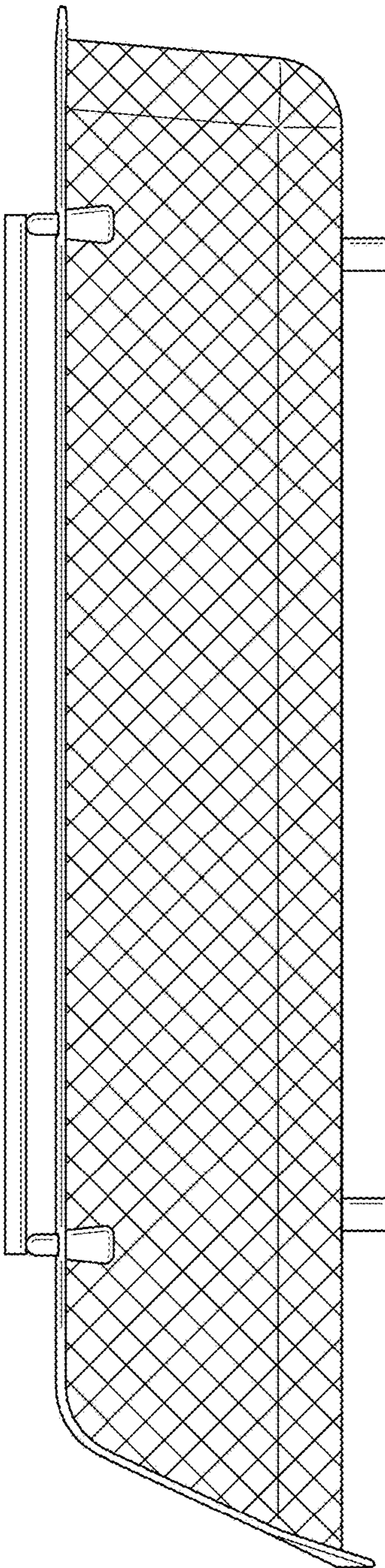

FIG. 5



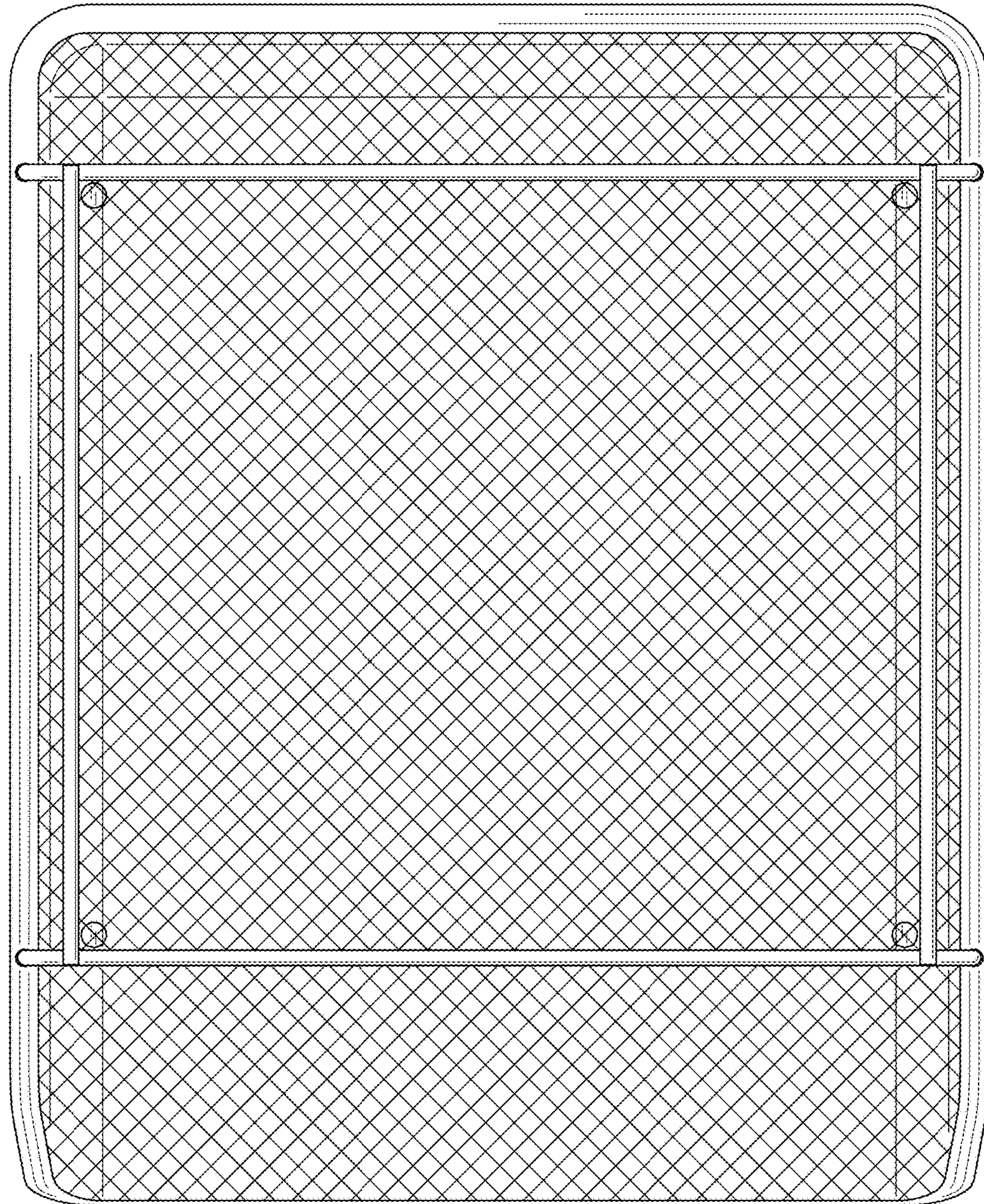

FIG. 6



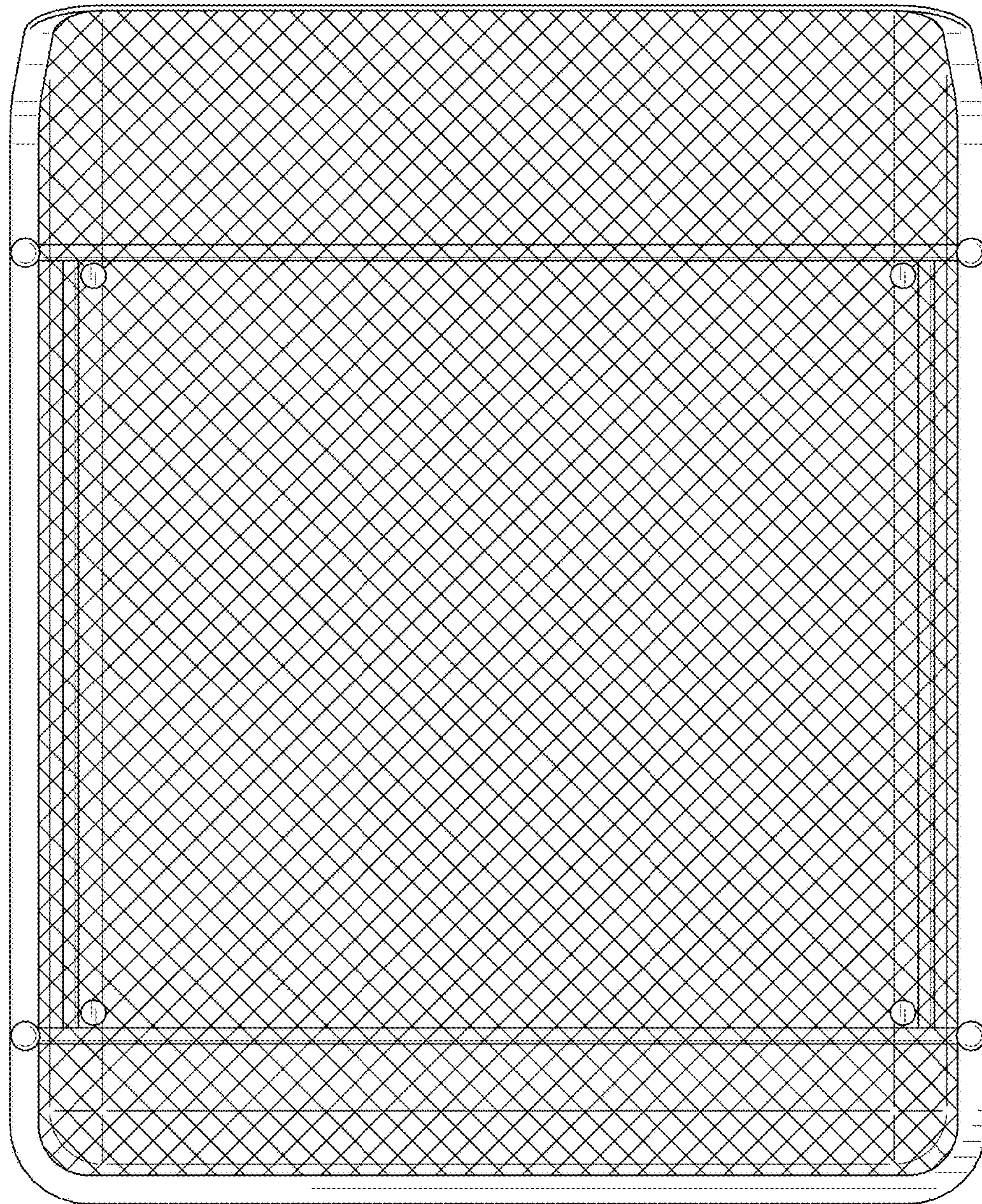

FIG. 7



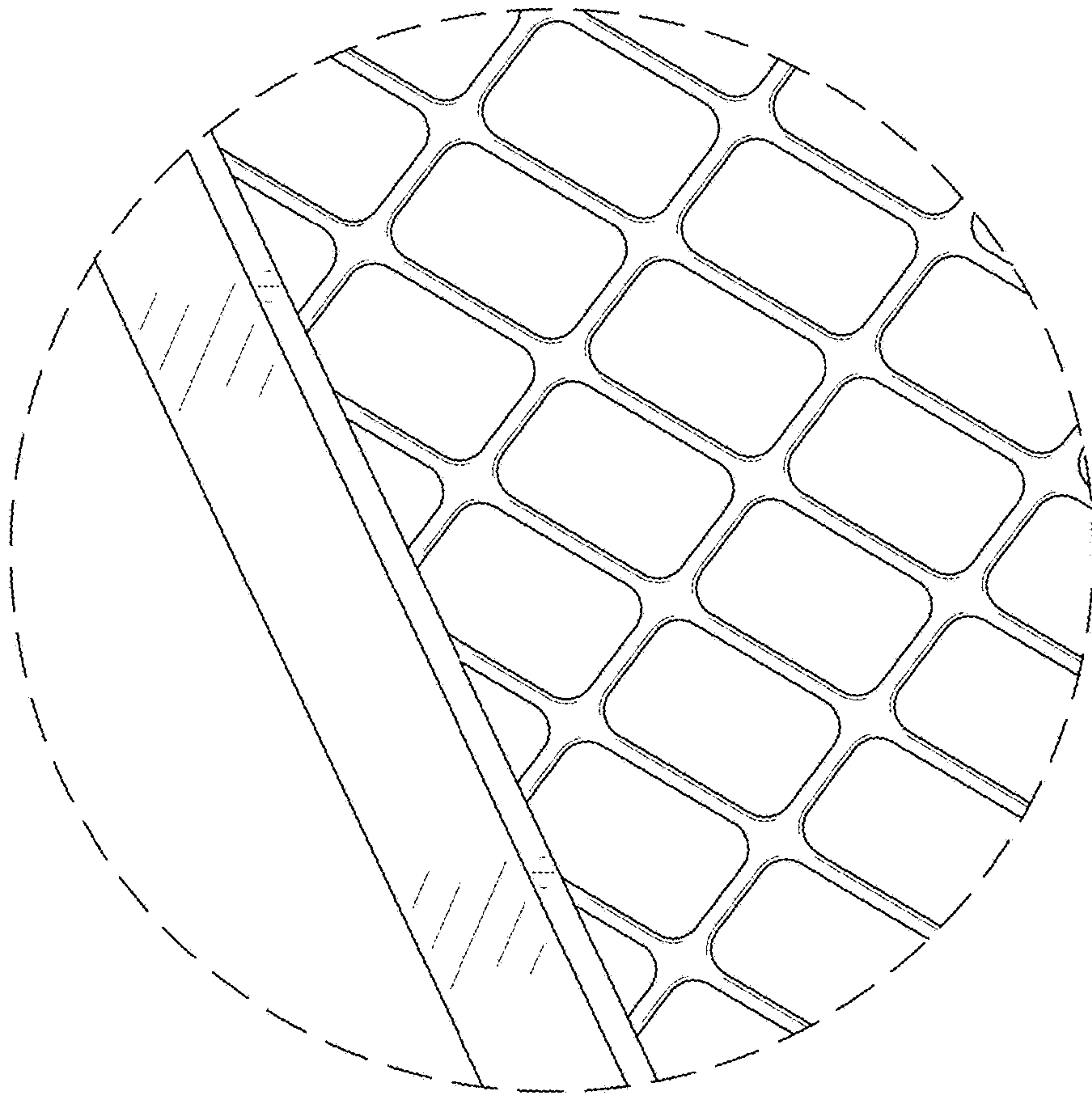

FIG. 8



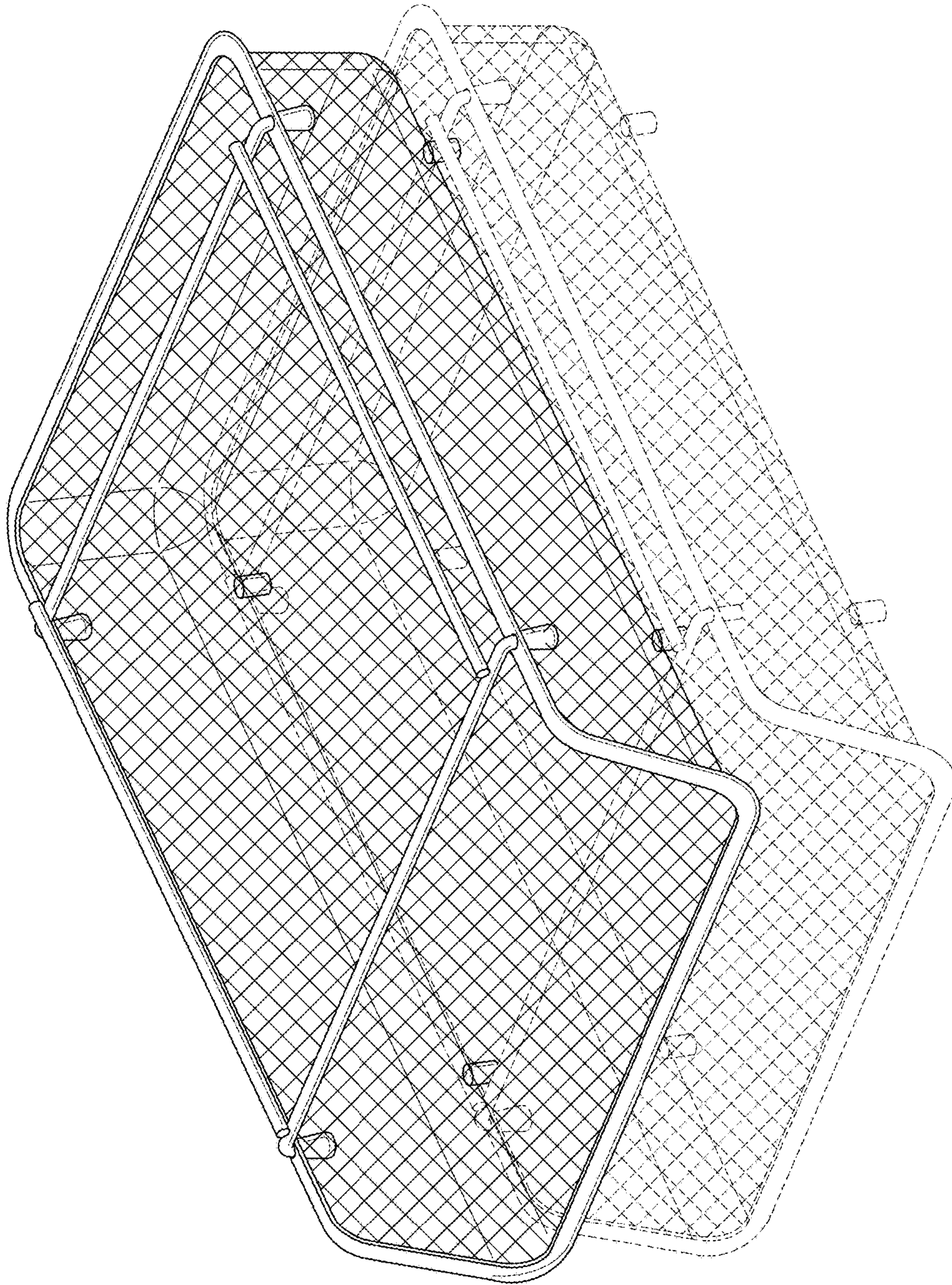

FIG. 9



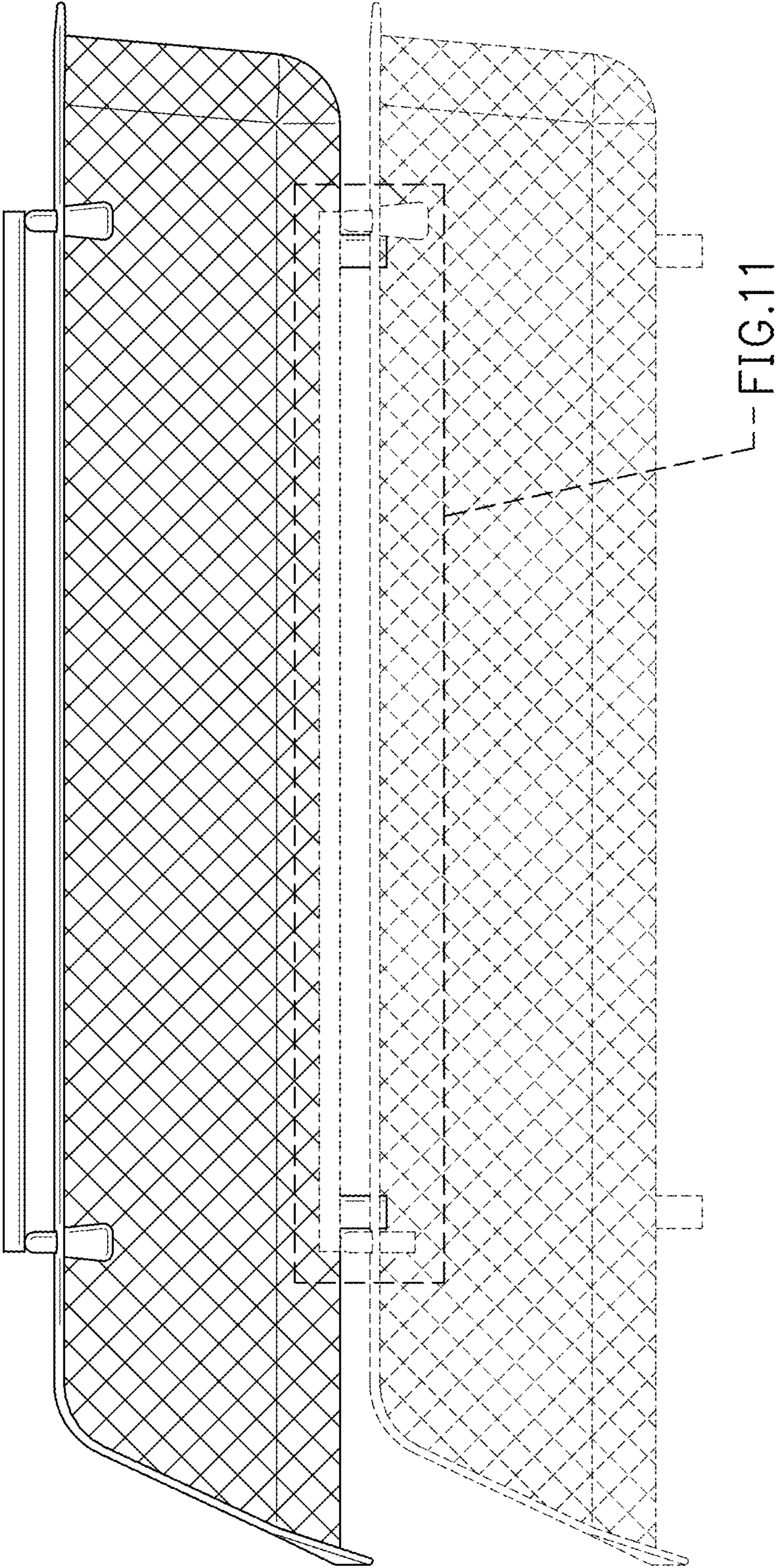

FIG. 10



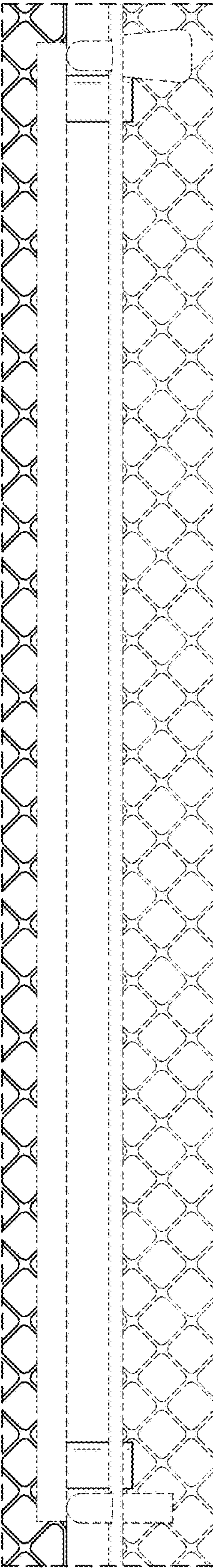

FIG. 11