



US00D825896S

(12) **United States Design Patent** (10) **Patent No.:** **US D825,896 S**
Apeatro et al. (45) **Date of Patent:** **** Aug. 21, 2018**

(54) **BIB GARMENT WITH CROSS-BODY FRONT**

(71) Applicant: **PRUNDISC, LLC**, Brooklyn Park, MN (US)

(72) Inventors: **Catherine Apeatro**, Brooklyn Park, MN (US); **Germain Apeatro**, Brooklyn Park, MN (US)

(73) Assignee: **Prundisc, LLC**, Brooklyn Park, MN (US)

(**) Term: **15 Years**

(21) Appl. No.: **29/600,202**

(22) Filed: **Apr. 10, 2017**

(51) **LOC (11) Cl.** **02-02**

(52) **U.S. Cl.**
USPC **D2/861**

(58) **Field of Classification Search**
USPC D2/720, 724, 739, 829, 834, 835, 840, D2/858, 861, 864; D3/221
CPC A41B 7/00; A41B 13/10; A41B 13/103; A41B 13/106; A41D 13/04; A41D 13/129; A41D 13/1236; Y10S 2/912; Y10S 2/913; Y10T 24/18; Y10T 24/3643
See application file for complete search history.

(56) **References Cited**

U.S. PATENT DOCUMENTS

1,097,024 A * 5/1914 Holverson A41B 7/00 2/124
D78,115 S * 3/1929 Long D2/835
2,022,878 A * 12/1935 Berger A41B 7/00 2/123

(Continued)

FOREIGN PATENT DOCUMENTS

EP 1090560 A2 4/2011
GB 2452912 A 3/2009

OTHER PUBLICATIONS

Amazon.com, McPolo's Cutest Pink Elephant 44® Silicone Baby Bib with Pocket, <https://www.amazon.com/McPolos-Cutest-El-ephant-Silicone-Pocket/dp/B00IDV3Z6O>, accessed on Aug. 18, 2016, United States.

(Continued)

Primary Examiner — Kevin K Rudzinski

Assistant Examiner — Paul D Bohannon

(74) *Attorney, Agent, or Firm* — Nicholas S. Kulmann, Esq.

(57) **CLAIM**

The ornamental design for a bib garment with cross-body front, as shown and described.

DESCRIPTION

FIG. 1 is an environmental perspective view of a bib garment with cross-body front design in use on a person; FIG. 2 is a perspective view of the bib garment with cross-body front design; FIG. 3 is a front view thereof; FIG. 4 is a back view thereof; FIG. 5 is a top view thereof; FIG. 6 is a bottom view thereof; FIG. 7 is a right side view thereof; FIG. 8 is a left side view thereof; FIG. 9 is a cross sectional top plan view taken from line 9-9 in FIG. 4, showing the waist pocket detail of the claimed design; FIG. 10 is a cross sectional top plan view taken from line 10-10 in FIG. 4, showing the wrist pocket detail of the claimed design; and, FIG. 11 is a cross sectional view taken from line 11-11 in FIG. 4, which cuts away the arm of the claim to show a side closure. The broken lines shown in the drawings represent environment associated with the claimed design and form no part thereof.

1 Claim, 5 Drawing Sheets

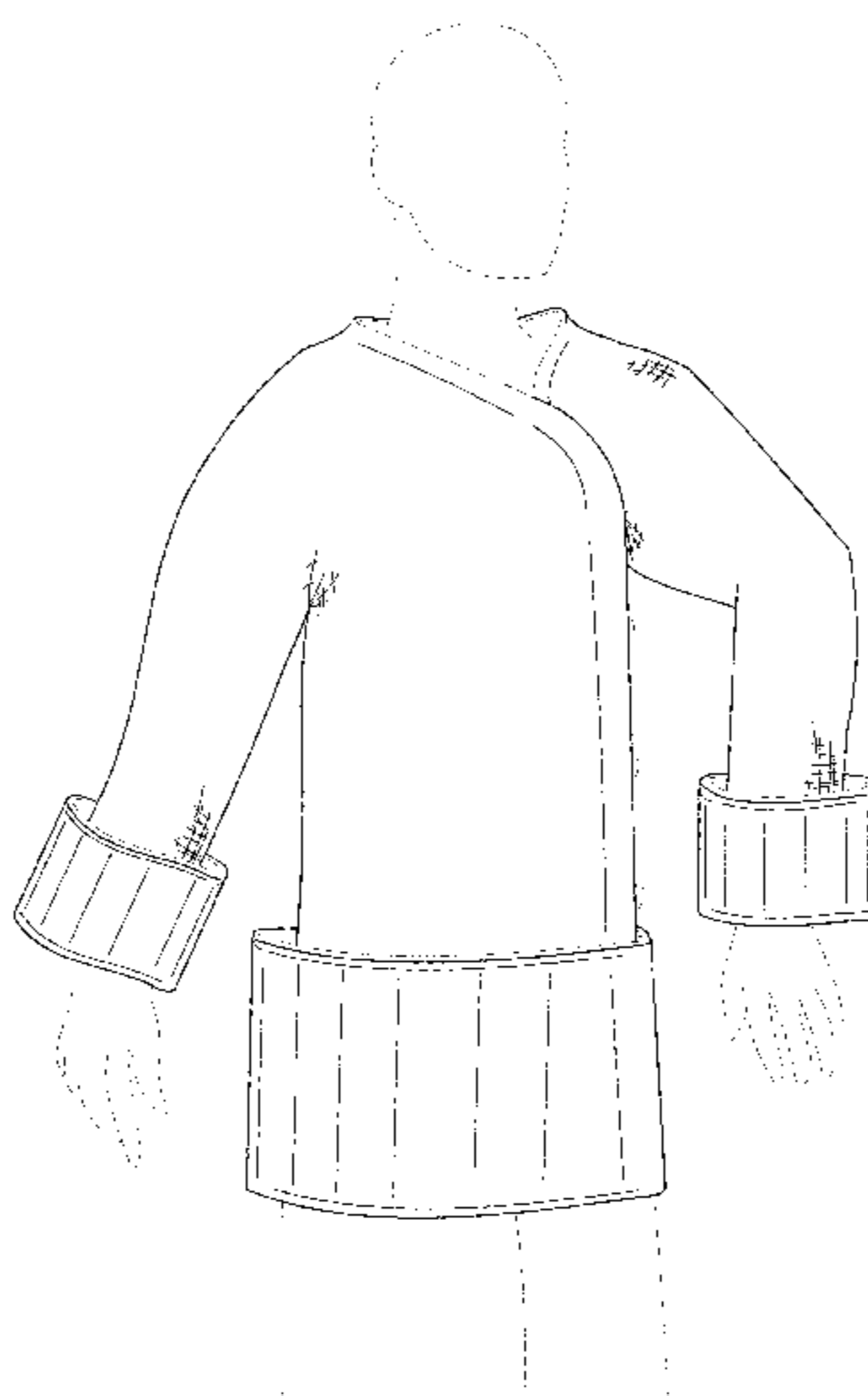

(56)

References Cited

U.S. PATENT DOCUMENTS

D109,798 S * 5/1938 Cohen D2/834
 D156,865 S * 1/1950 Burell D2/835
 D161,176 S * 12/1950 Handler D2/835
 D162,023 S * 2/1951 Giovagnoni D2/724
 2,672,614 A * 3/1954 Zimmerman A41B 13/103
 2,701,364 A * 2/1955 Palm A41D 13/1236
 2,792,572 A * 5/1957 Rosenbaum A41D 1/04
 D193,760 S * 10/1962 Sanders 2/123
 3,210,773 A * 10/1965 Lewis A41D 13/04
 3,407,407 A 10/1968 Hollander
 3,616,464 A * 11/1971 Whitten A41D 13/04
 D233,634 S * 11/1974 Snider D2/720
 3,857,116 A * 12/1974 Meeker A41B 13/10
 3,945,048 A 3/1976 Shearer
 3,995,321 A 12/1976 Johnson
 4,434,511 A * 3/1984 Weiser A41D 13/129
 4,639,946 A * 2/1987 Koenig A41B 13/00
 4,663,779 A 5/1987 Bible
 5,036,547 A 8/1991 Silas
 5,218,721 A 6/1993 Matthews

D358,473 S * 5/1995 Taylor D2/861
 5,490,289 A 2/1996 Lehrer
 7,269,857 B2 9/2007 Cymbol
 D640,449 S * 6/2011 Roach D2/861
 D646,467 S * 10/2011 Campbell D2/739
 D662,283 S * 6/2012 Gobble D2/829
 D679,894 S * 4/2013 D'Angelo D2/840
 D679,895 S * 4/2013 Greenberg D2/840
 D680,304 S * 4/2013 Greenberg D2/840
 D726,395 S * 4/2015 Lewis D2/864
 9,226,529 B2 1/2016 Monahon
 9,392,821 B1 7/2016 Baker
 D812,352 S * 3/2018 Combs D2/864
 2004/0128729 A1 7/2004 Lat
 2004/0261152 A1 12/2004 Mottl
 2007/0143904 A1 6/2007 Brown
 2008/0289152 A1 * 11/2008 Surratt F21S 8/00
 2009/0019615 A1 1/2009 Young
 2012/0266346 A1 10/2012 Kessler, III
 2013/0111644 A1 5/2013 Timmons
 2015/0351462 A1 12/2015 Thomas-Penny

OTHER PUBLICATIONS

Google.com, Google Image Search for Bibs, <https://www.google.com/search?q=adult+bib+with+pockets+to+catch+food&espv=2&biw=1920&bih=955&tbm=isch&imgil=bmj6f34c2TwyNM%253A%253BH>, accessed on Jul. 19, 2016, United States.

* cited by examiner

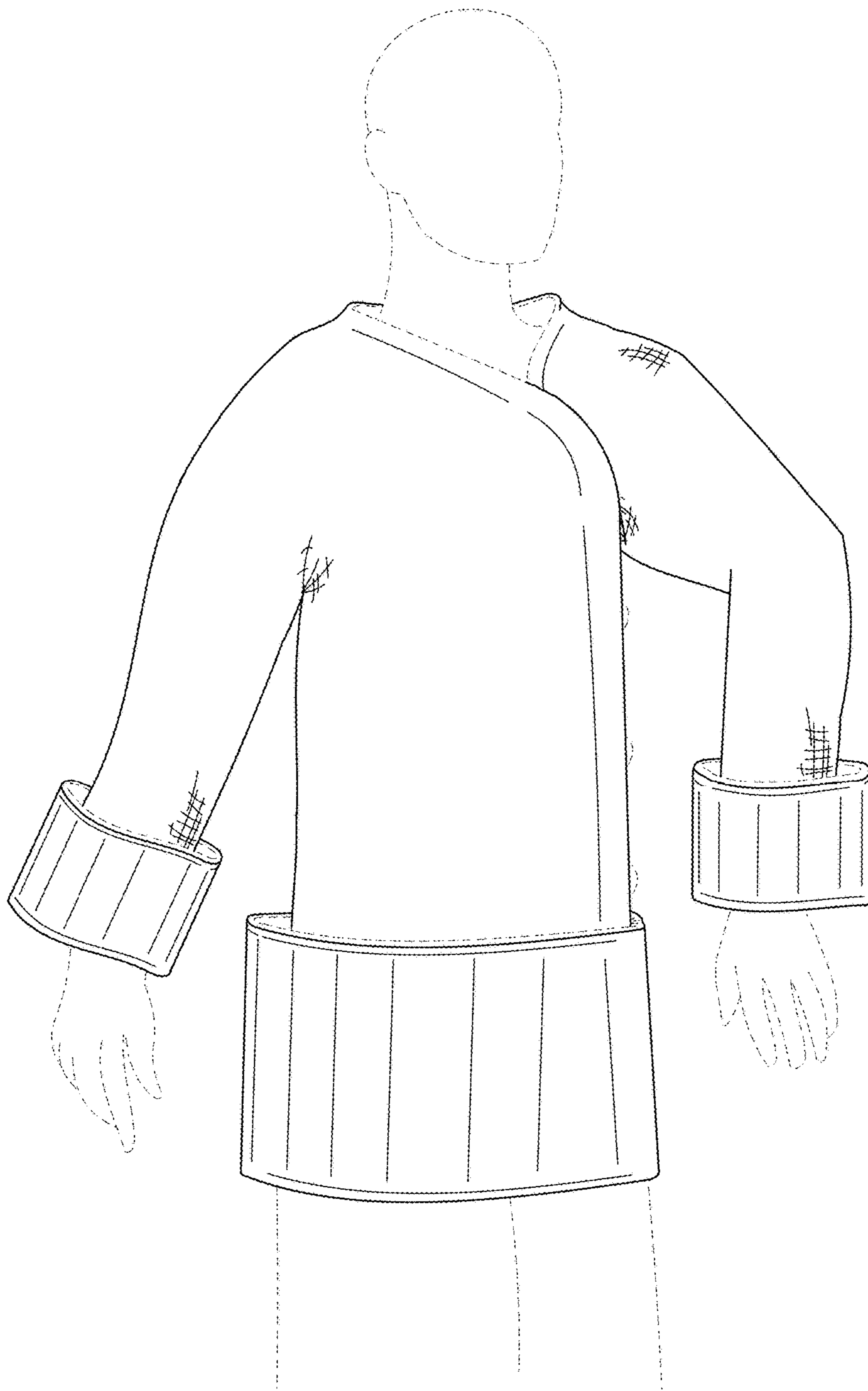

FIG. 1

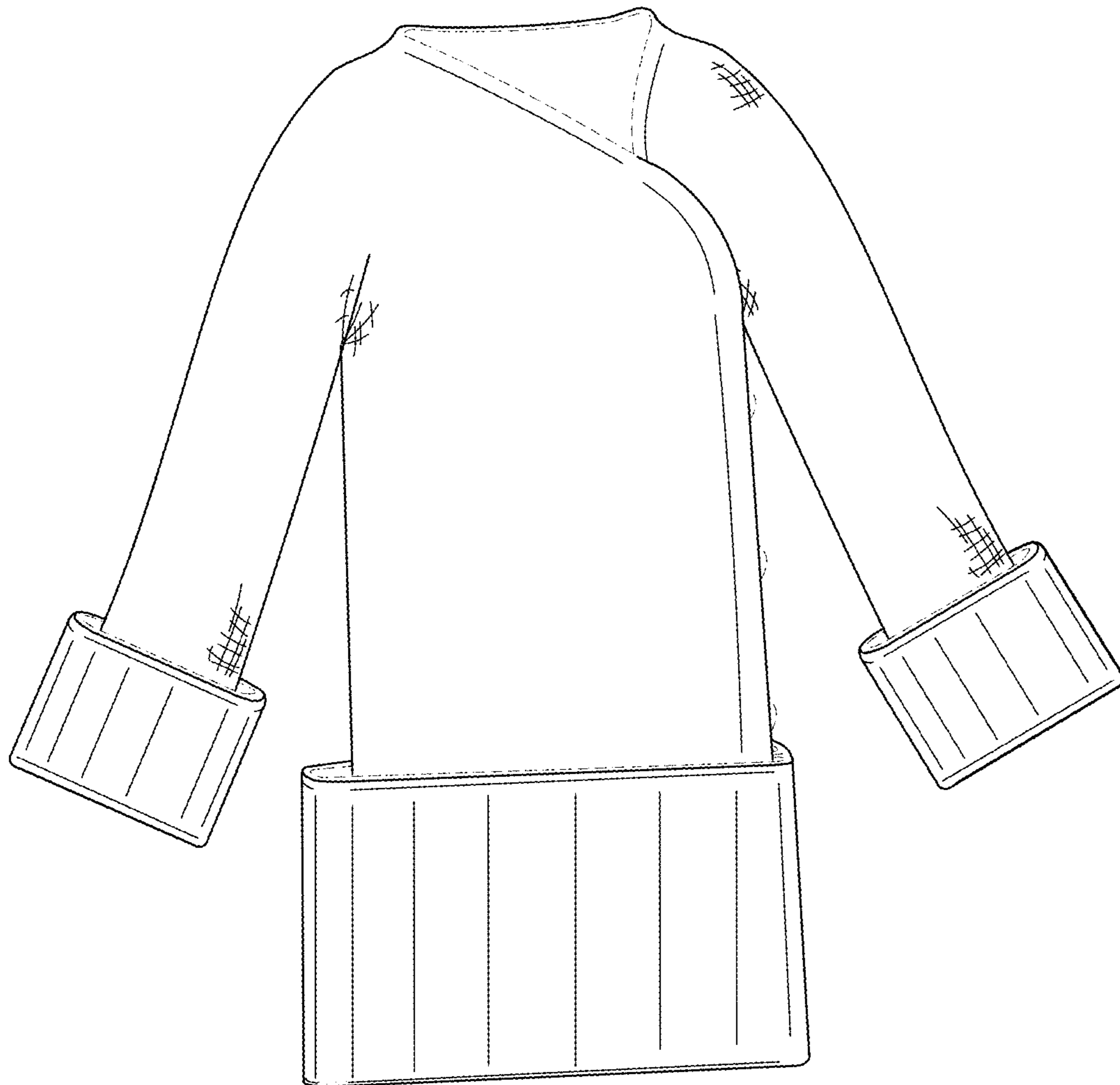

FIG. 2

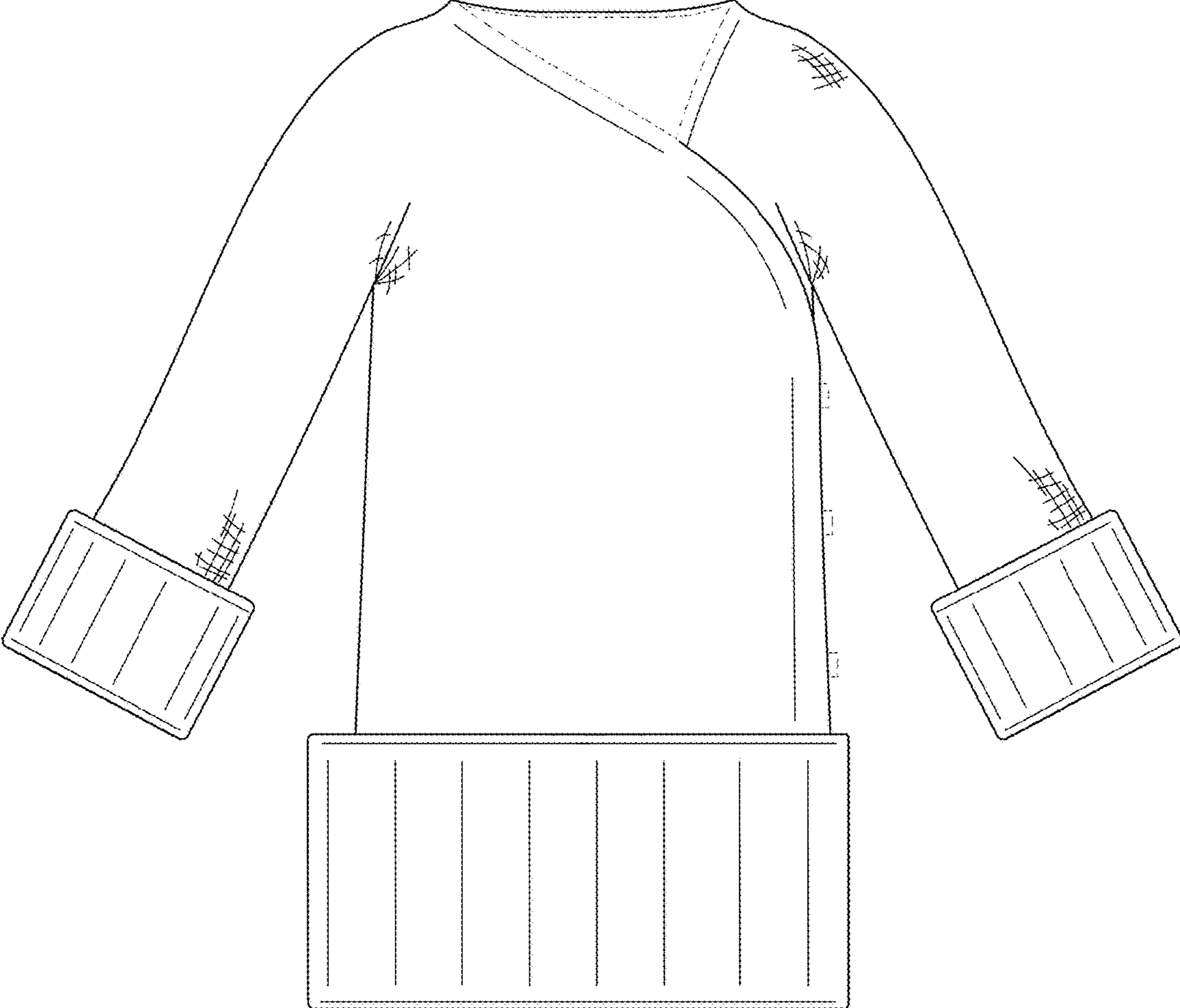

FIG. 3

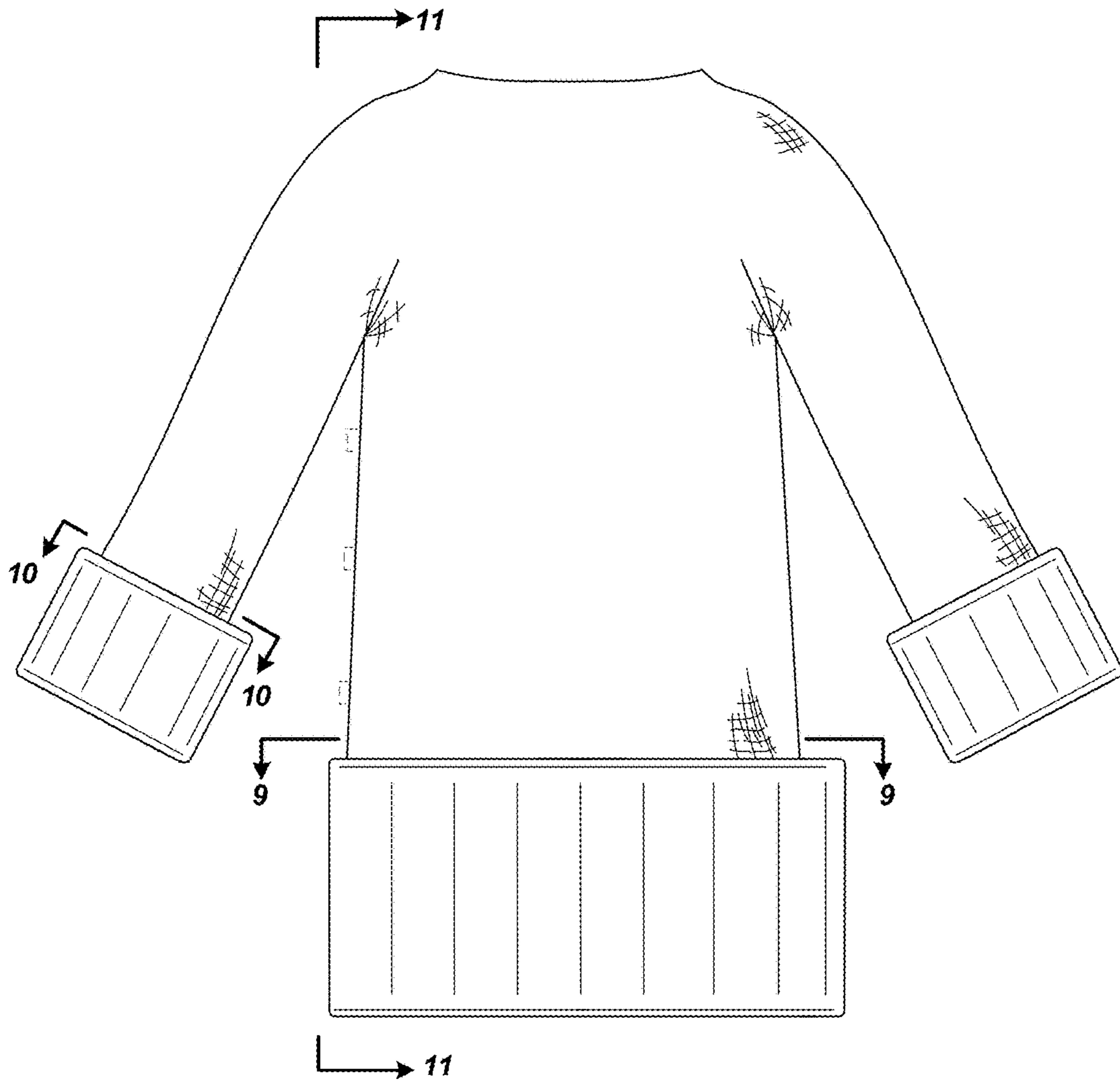

FIG. 4

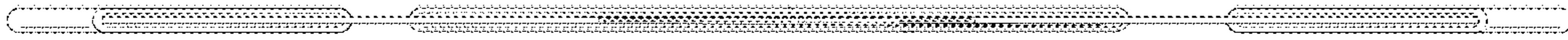

FIG. 5

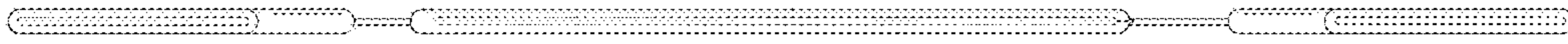

FIG. 6

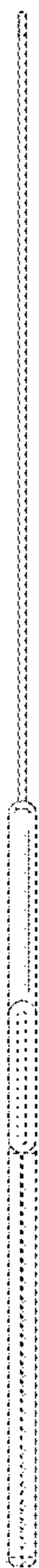

FIG. 7



FIG. 8

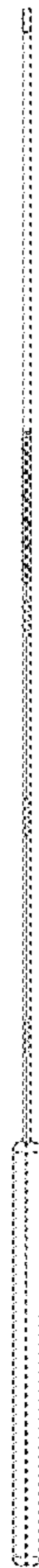

FIG. 11

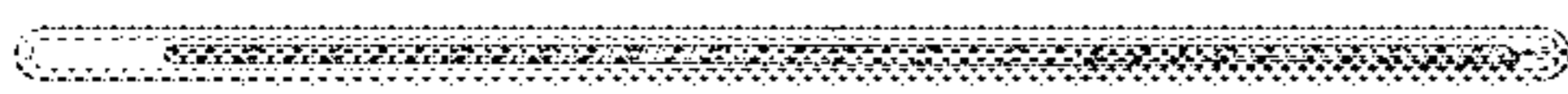

FIG. 9

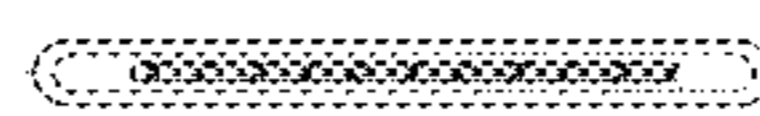

FIG. 10