



US00D825893S

(12) **United States Design Patent**
Morisch et al.

(10) **Patent No.:** **US D825,893 S**

(45) **Date of Patent:** **** Aug. 21, 2018**

- (54) **SHIRT COLLAR**
- (71) Applicants: **Amy Morisch**, Newport Beach, CA
(US); **Tom Hurst**, Newport Beach, CA
(US)
- (72) Inventors: **Amy Morisch**, Newport Beach, CA
(US); **Tom Hurst**, Newport Beach, CA
(US)
- (**) Term: **15 Years**
- (21) Appl. No.: **29/585,307**
- (22) Filed: **Nov. 22, 2016**
- (51) **LOC (11) Cl.** **02-02**
- (52) **U.S. Cl.**
USPC **D2/849**
- (58) **Field of Classification Search**
USPC D2/602, 717, 728, 750, 840, 841, 849;
D27/148
CPC A41B 1/00; A41B 1/02; A41B 1/04; A41B
1/08; A41B 3/00; A41B 3/02; A41B 3/06;
A41B 5/00; A41B 9/06; A41D 13/0012;
A41D 13/0015; A41D 27/16; A41D
27/24; B65D 85/182
See application file for complete search history.

(56) **References Cited**

U.S. PATENT DOCUMENTS

- 1,716,042 A * 6/1929 Goldberg A41B 3/00
2/116
- 1,941,185 A * 12/1933 O'shea B65D 85/182
223/83
- D98,566 S * 2/1936 Helfgott D2/750
- 2,243,230 A * 5/1941 Vandermade B65D 85/182
223/71
- 2,265,808 A * 12/1941 Jacobi A41B 3/00
2/116
- 2,444,381 A * 6/1948 Sperber A41B 3/00
2/143

- 2,585,690 A * 2/1952 Schafer A41B 3/02
2/127
- 2,633,576 A * 4/1953 Powers A41D 27/16
2/129
- 2,651,042 A * 9/1953 Lombardi A41B 1/00
2/108
- 2,668,295 A * 2/1954 Garrido A41B 3/00
2/132
- D174,186 S * 3/1955 London D2/849
- 2,710,969 A * 6/1955 Renzi A41B 3/00
2/116
- D179,802 S * 3/1957 Gayla D2/849
- 4,100,622 A * 7/1978 Juelg, Jr. A41B 1/08
2/115
- D306,792 S * 3/1990 Gates D2/849
- 5,090,060 A * 2/1992 Gates A41D 13/0015
2/115
- 5,758,363 A * 6/1998 Winfree A41D 1/04
2/108

(Continued)

Primary Examiner — Kevin K Rudzinski
Assistant Examiner — Paul D Bohannon
(74) *Attorney, Agent, or Firm* — Kenny Nguyen, Esq.;
Eastman & McCartney LLP

(57) **CLAIM**

The ornamental design for a shirt collar, as shown and described.

DESCRIPTION

FIG. 1 is a front-right-top perspective view of a shirt collar showing my new design;
FIG. 2 is a back-left-top perspective view thereof;
FIG. 3 is a front elevational view thereof;
FIG. 4 is a back elevation view thereof;
FIG. 5 is a right elevational view thereof; and,
FIG. 6 is a left elevational view thereof.
The broken line showing of the shirt in all views is for illustrative purposes only and forms no part of the claimed design.

1 Claim, 6 Drawing Sheets

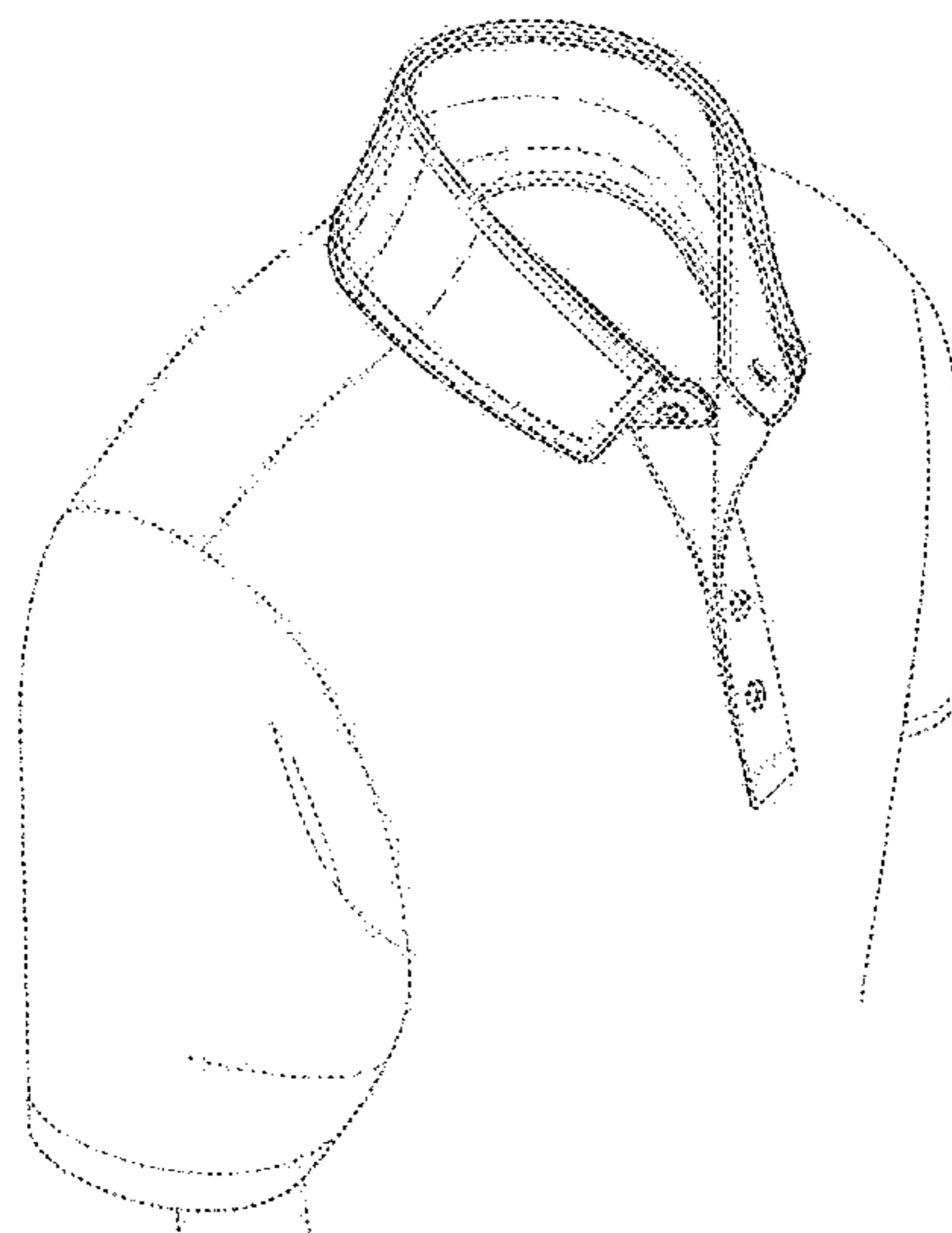

(56)

References Cited

U.S. PATENT DOCUMENTS

D398,138 S * 9/1998 Glennie D2/602
D399,638 S * 10/1998 Watson D2/728
5,875,653 A * 3/1999 Pedersen A41B 1/00
2/116
D432,289 S * 10/2000 Randolph D2/602
D491,713 S * 6/2004 Wilson, II D2/849
7,043,765 B1 * 5/2006 Otsubo A41B 1/00
2/115
D530,853 S * 10/2006 Chen D27/148
D624,278 S * 9/2010 Smith D2/717
D625,899 S * 10/2010 Reis D2/717
D632,872 S * 2/2011 Isler D2/841
D674,579 S * 1/2013 Grabowski D2/849
D709,269 S * 7/2014 Kenney D2/717
D728,895 S * 5/2015 Levinas D2/602
9,204,671 B1 * 12/2015 Kessler, III A41B 1/08
D755,479 S * 5/2016 Darmour D2/849
D780,409 S * 3/2017 Drew D2/840
9,603,400 B2 * 3/2017 Kenney A41D 27/24
D795,535 S * 8/2017 Azoulay D2/840
D796,155 S * 9/2017 Hartley D2/849
D798,030 S * 9/2017 Ketcham D2/840
2009/0282604 A1 * 11/2009 Litt A41B 5/00
2/116
2011/0126341 A1 * 6/2011 Soriano A41B 1/02
2/113
2011/0277208 A1 * 11/2011 Wortman A41D 13/0015
2/69
2012/0266353 A1 * 10/2012 Ferre A41D 13/0012
2/125
2015/0313289 A1 * 11/2015 Lester A41B 3/06
223/2
2016/0183600 A1 * 6/2016 Patterson A41B 9/06
2/128
2017/0143052 A1 * 5/2017 Kenney A41D 13/0015

* cited by examiner

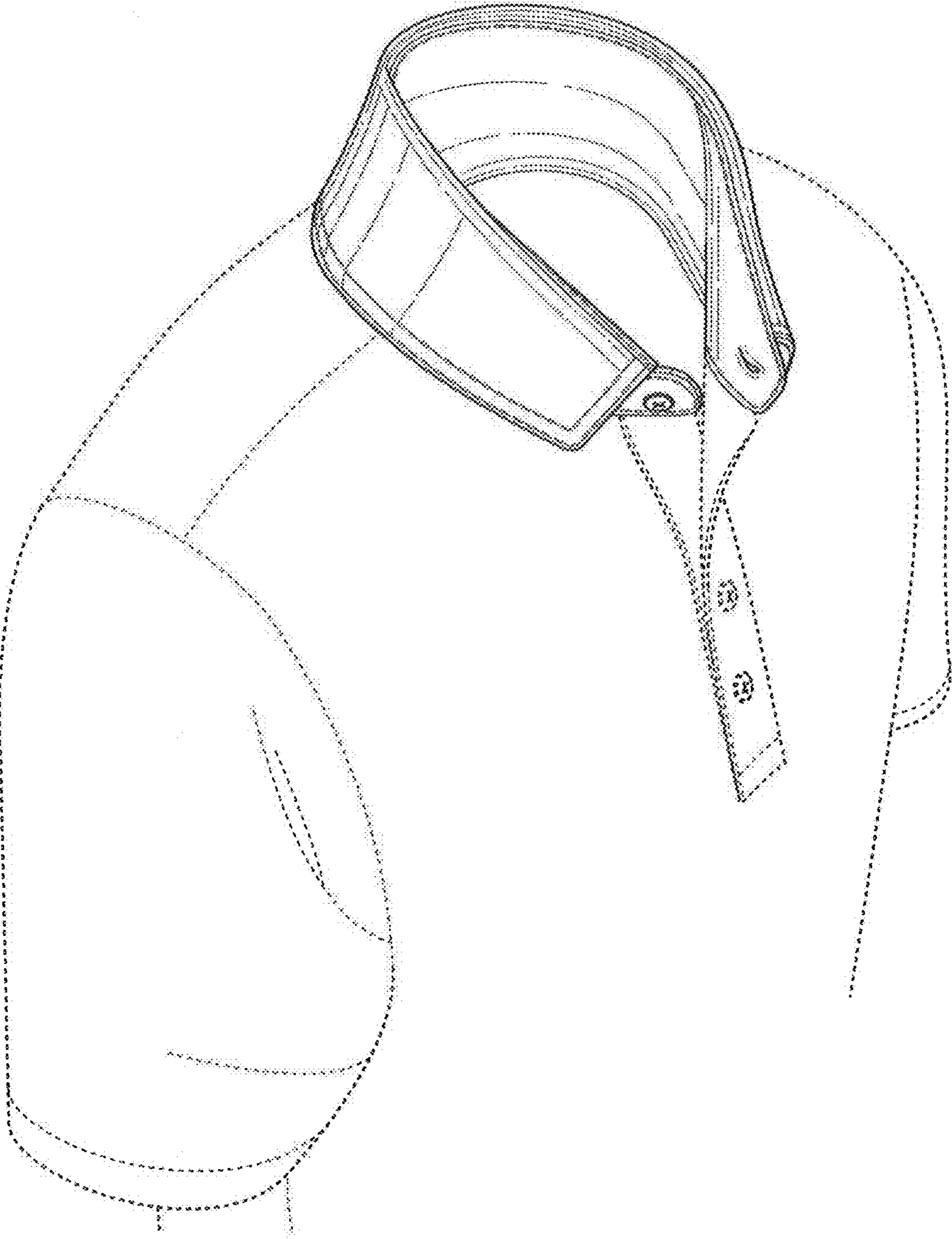

FIG. 1

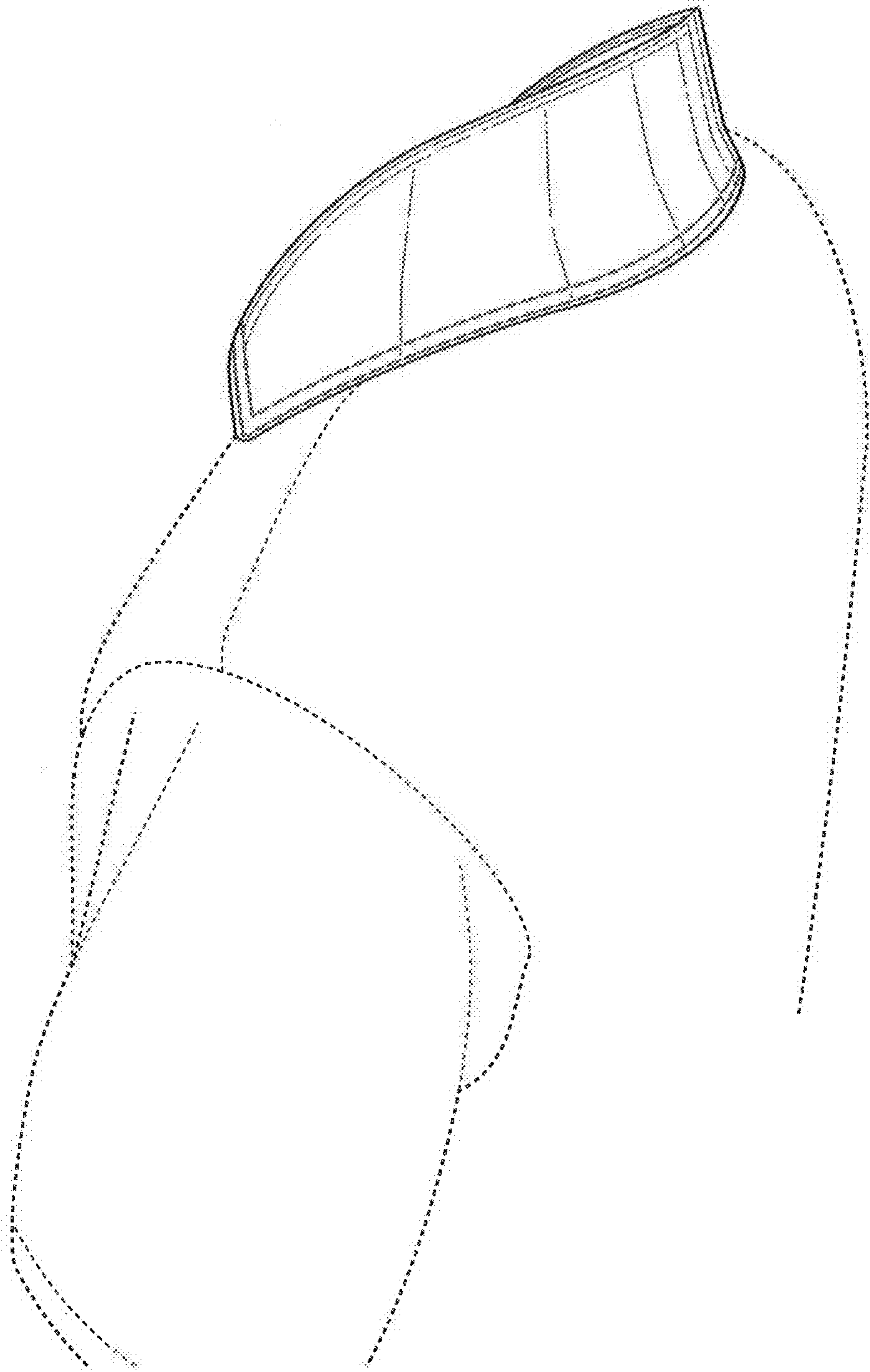

FIG. 2

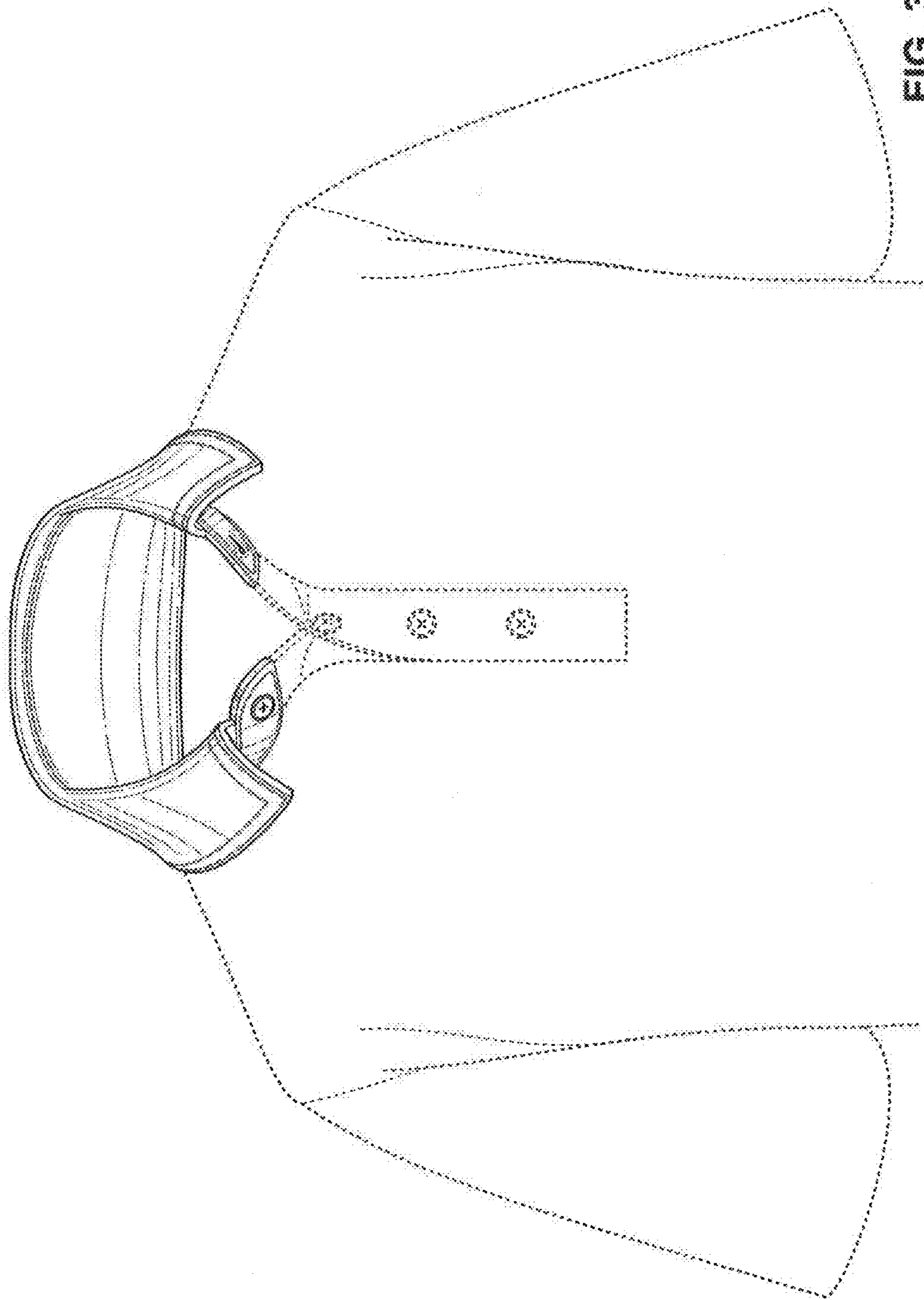

FIG. 3

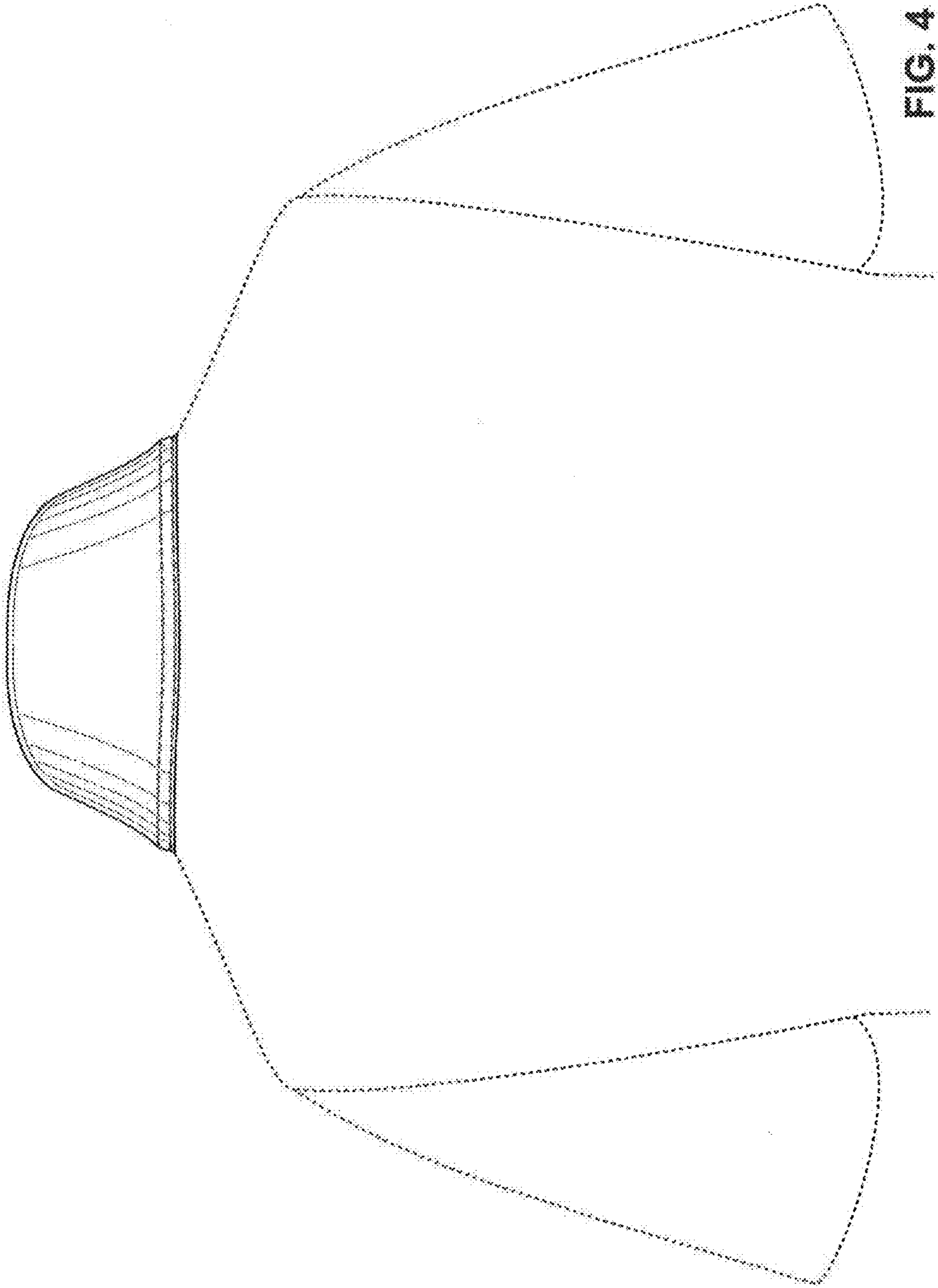

FIG. 4

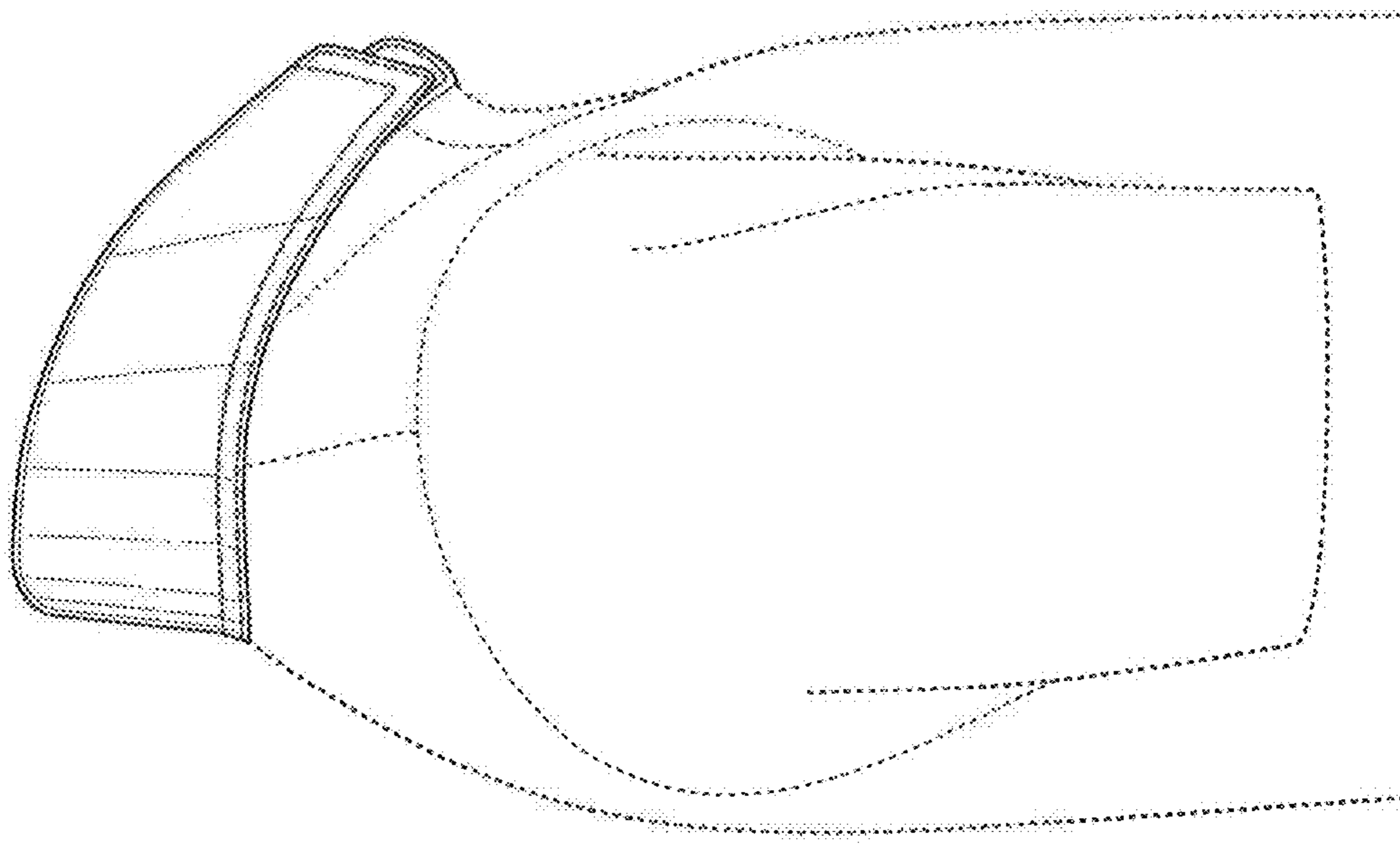

FIG. 5

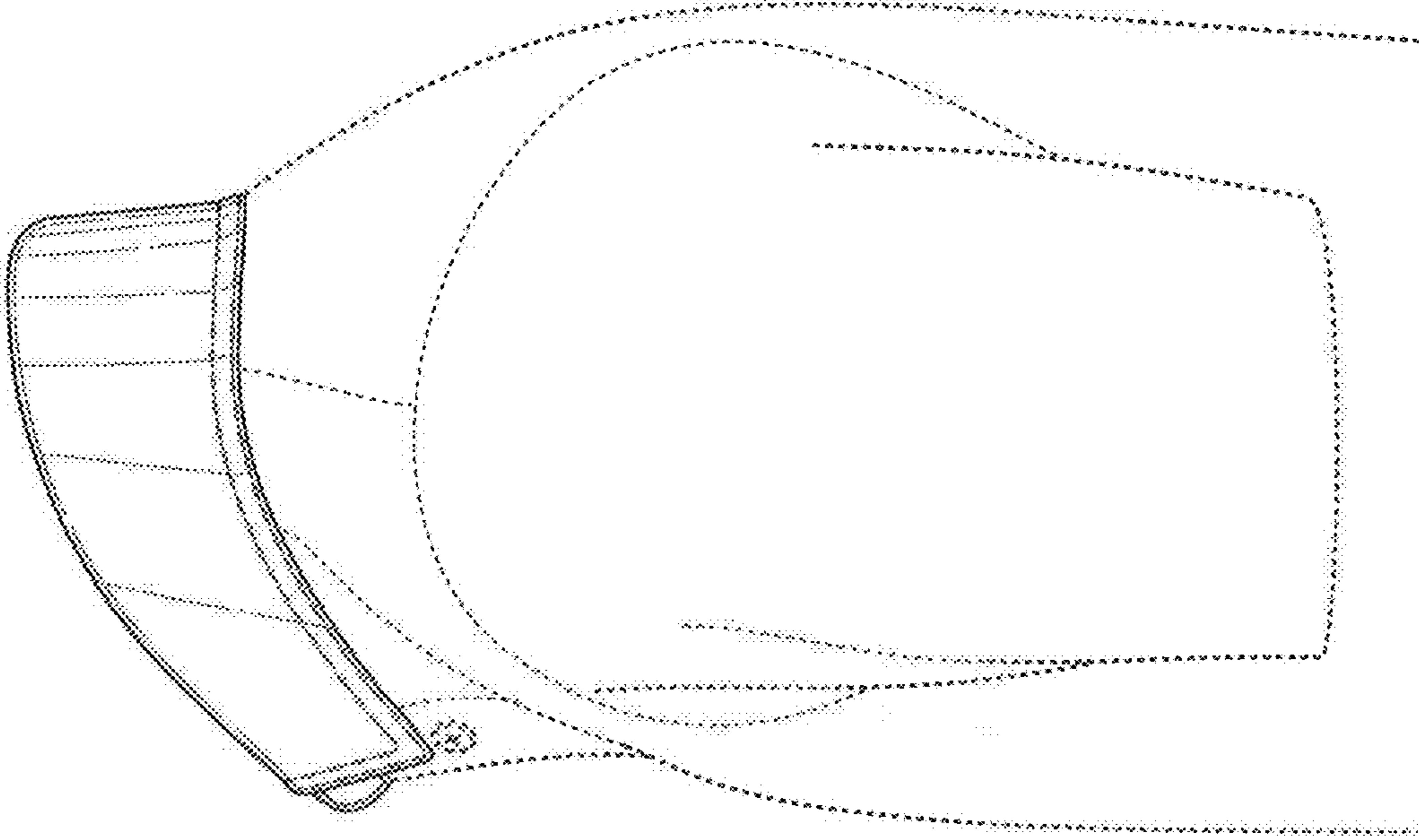

FIG. 6