



US00D825881S

(12) **United States Design Patent** (10) **Patent No.:** **US D825,881 S**  
**Cope et al.** (45) **Date of Patent:** **\*\* Aug. 14, 2018**

(54) **WHEELED QUARTER DOLLY**  
(71) Applicant: **CHEP Technology Pty Limited**,  
Sydney, New South Wales (AU)  
(72) Inventors: **Andy Cope**, Leopoldsburg (BE); **Sanjiv Takyar**, Weybridge (GB); **Karl Michael Wesson**, Weybridge (GB)  
(73) Assignee: **CHEP Technology Pty Limited**,  
Sydney (AU)  
(\*\*) Term: **15 Years**  
(21) Appl. No.: **29/572,344**  
(22) Filed: **Jul. 27, 2016**  
(30) **Foreign Application Priority Data**

Jan. 28, 2016 (EM) ..... 002962951

(51) **LOC (11) Cl.** ..... **12-02**  
(52) **U.S. Cl.**  
USPC ..... **D34/23**  
(58) **Field of Classification Search**  
USPC ..... D34/12, 13, 14, 15, 16, 17, 18, 19, 20,  
D34/21, 22, 23, 24, 25, 26, 27;  
280/47.34, 47.35, 79.11, 79.5, 79.3, 79.6,  
280/651, 79.2, 79.4; 29/426.2, 428;  
248/129, 346.01; 108/53.3  
CPC ..... B62B 2202/90; B62B 3/1476; B62B 3/16  
See application file for complete search history.

(56) **References Cited**

**U.S. PATENT DOCUMENTS**

D390,314 S \* 2/1998 Chen ..... D34/23  
D420,188 S \* 2/2000 Betcher ..... D34/23  
D437,669 S \* 2/2001 Blason ..... D34/23  
D456,972 S \* 5/2002 Blason ..... D34/23  
7,036,833 B1 \* 5/2006 Berna ..... B62B 3/04  
280/166  
D711,614 S \* 8/2014 Shitrit ..... D34/23  
2002/0153682 A1 \* 10/2002 Gruber ..... B62B 3/006  
280/79.11

2012/0018966 A1 \* 1/2012 Moore ..... B62B 3/002  
280/79.11  
2013/0154218 A1 \* 6/2013 Tiilikainen ..... B62B 3/16  
280/79.11  
2015/0135999 A1 \* 5/2015 Takyar ..... B65D 19/0018  
108/53.3

**OTHER PUBLICATIONS**

Chep. "Plastic Dolly", <http://www.chep.com/Pallets/Plastic-Dolly-600-x-400-mm-06040/de-AT/#>. Apr. 11, 2017. shown in p. 1. (Year: 2017).\*  
Amazon. "DeVault Enterprises . . ." [https://www.amazon.com/DeVault-Enterprises-DEV4000-04GB-Multi-Purpose/dp/B00Q721W6G/ref=pd\\_sim\\_328\\_2?encoding=UTF8&pd\\_rd\\_i=B00Q721W6G&pd\\_rd\\_r=ACBPCM7NPQE5MABVS5Q7&pd\\_rd\\_w=fhH4s&pd\\_rd\\_wg=az5JY&psc=1&refRID=ACBPCM7NPQE5MABVS5Q7](https://www.amazon.com/DeVault-Enterprises-DEV4000-04GB-Multi-Purpose/dp/B00Q721W6G/ref=pd_sim_328_2?encoding=UTF8&pd_rd_i=B00Q721W6G&pd_rd_r=ACBPCM7NPQE5MABVS5Q7&pd_rd_w=fhH4s&pd_rd_wg=az5JY&psc=1&refRID=ACBPCM7NPQE5MABVS5Q7). Apr. 16, 2017. (Year: 2017).\*

\* cited by examiner

*Primary Examiner* — Cynthia Ramirez  
*Assistant Examiner* — Michael A Maharajh  
(74) *Attorney, Agent, or Firm* — Allen, Dyer, Doppelt & Gilchrist, P.A.

(57) **CLAIM**

The ornamental design for a wheeled quarter dolly, as shown and described.

**DESCRIPTION**

FIG. 1 is a top perspective view of a wheeled quarter dolly showing our new design;  
FIG. 2 is a left-side view thereof;  
FIG. 3 is a right-side view thereof;  
FIG. 4 is a front view thereof;  
FIG. 5 is a back view thereof;  
FIG. 6 is a top view thereof; and,  
FIG. 7 is a bottom view thereof.

(Continued)

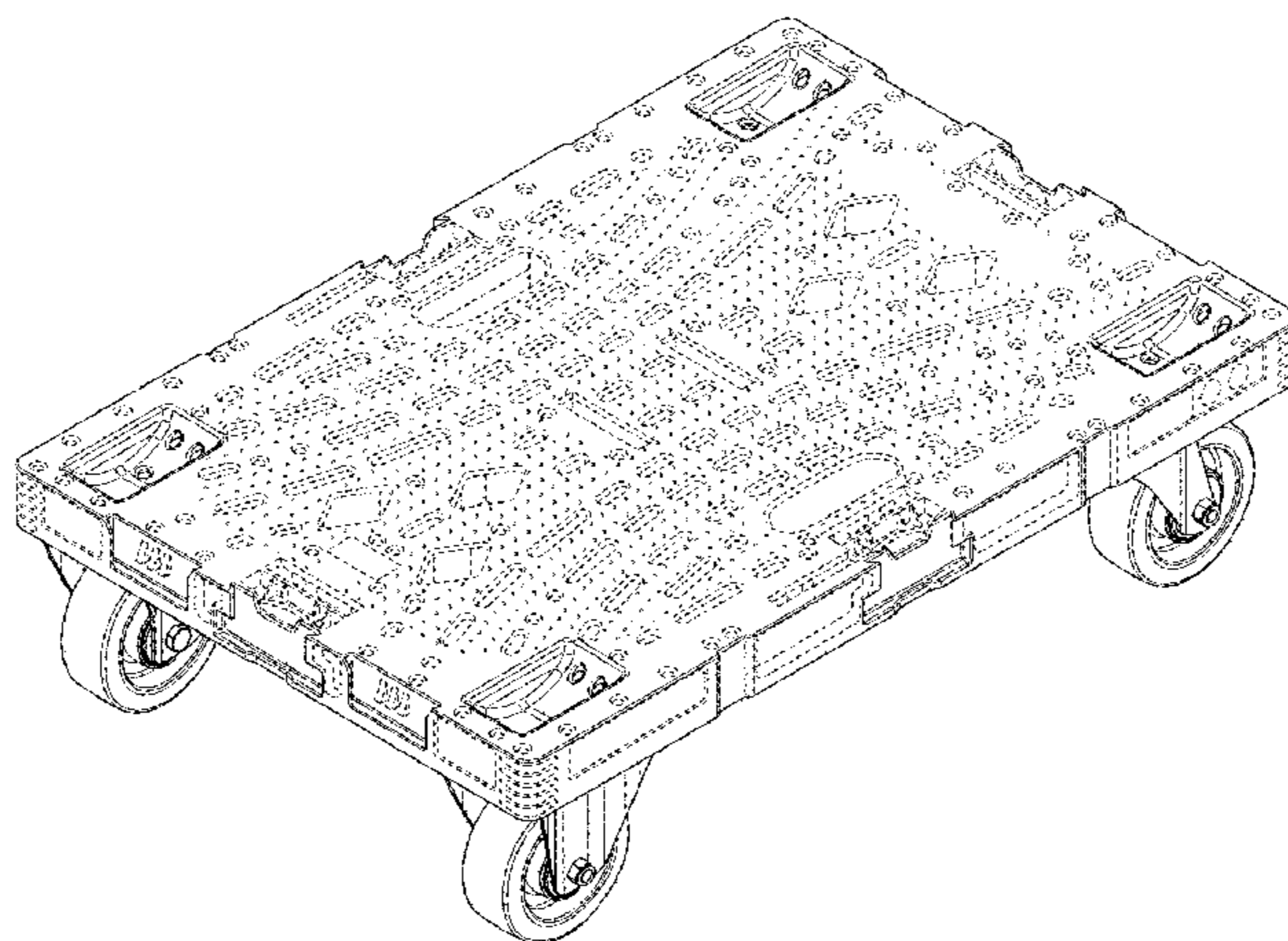

The broken lines shown in the figures are for the purpose of illustrating portions of the wheeled quarter dolly which form no part of the claimed design.

**1 Claim, 7 Drawing Sheets**

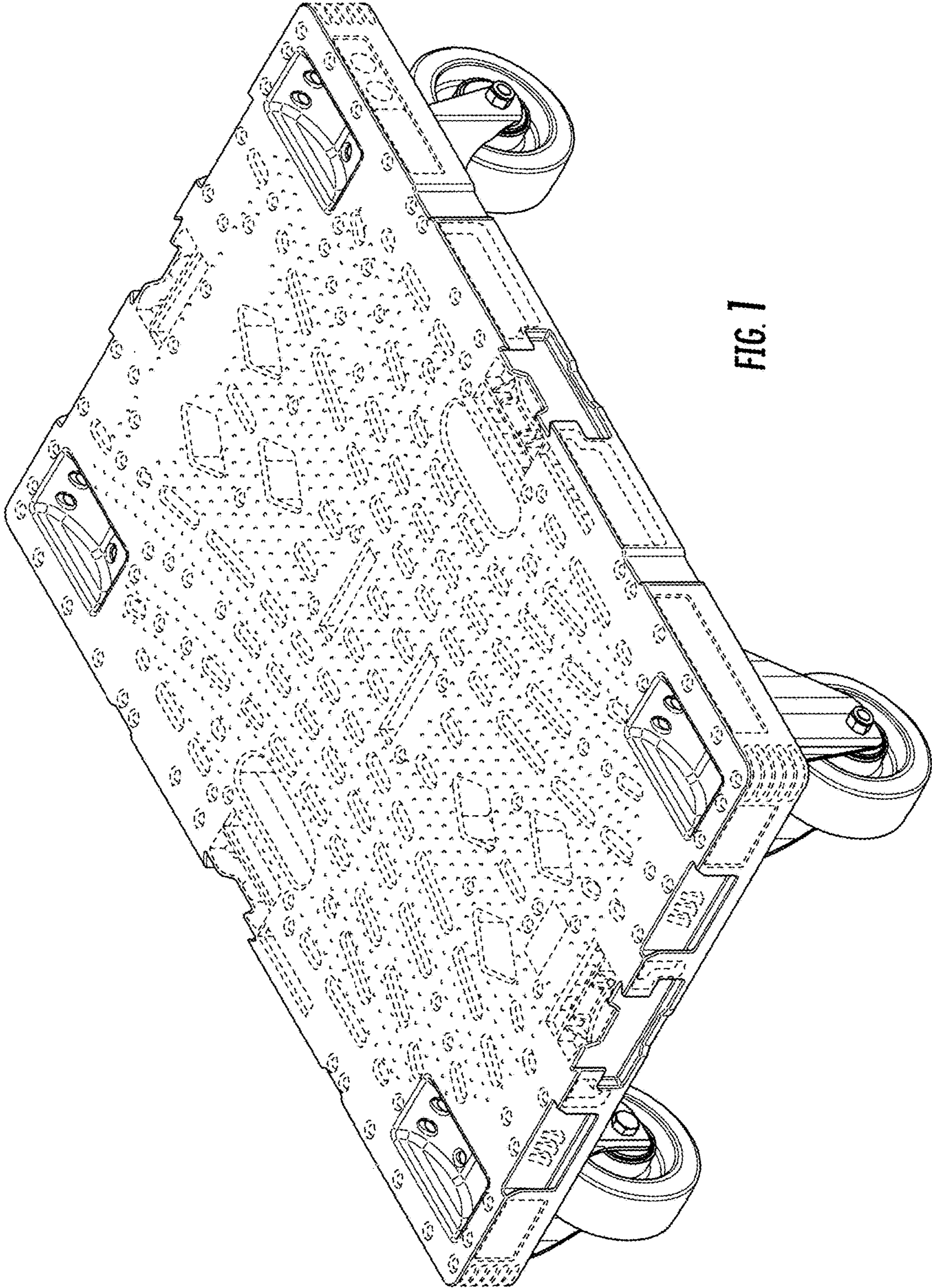

FIG. 1

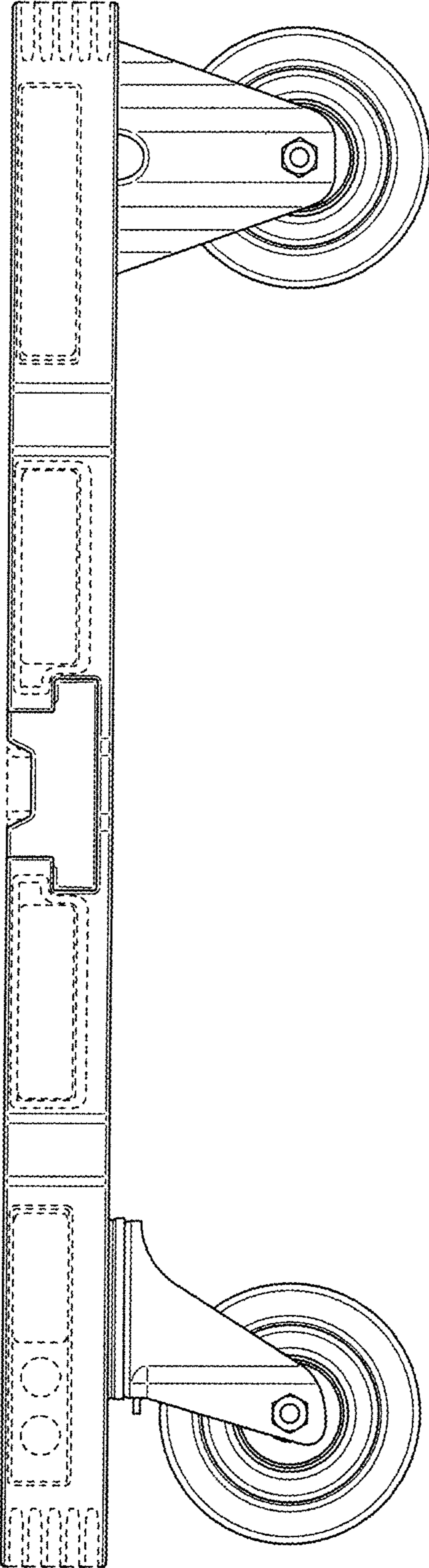

FIG. 2

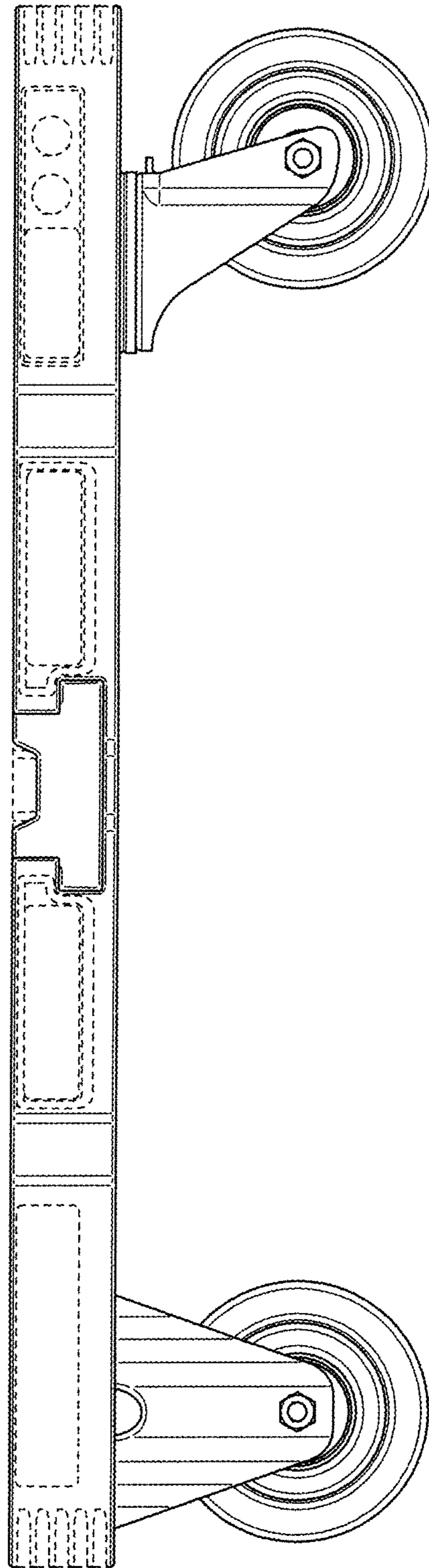

FIG. 3

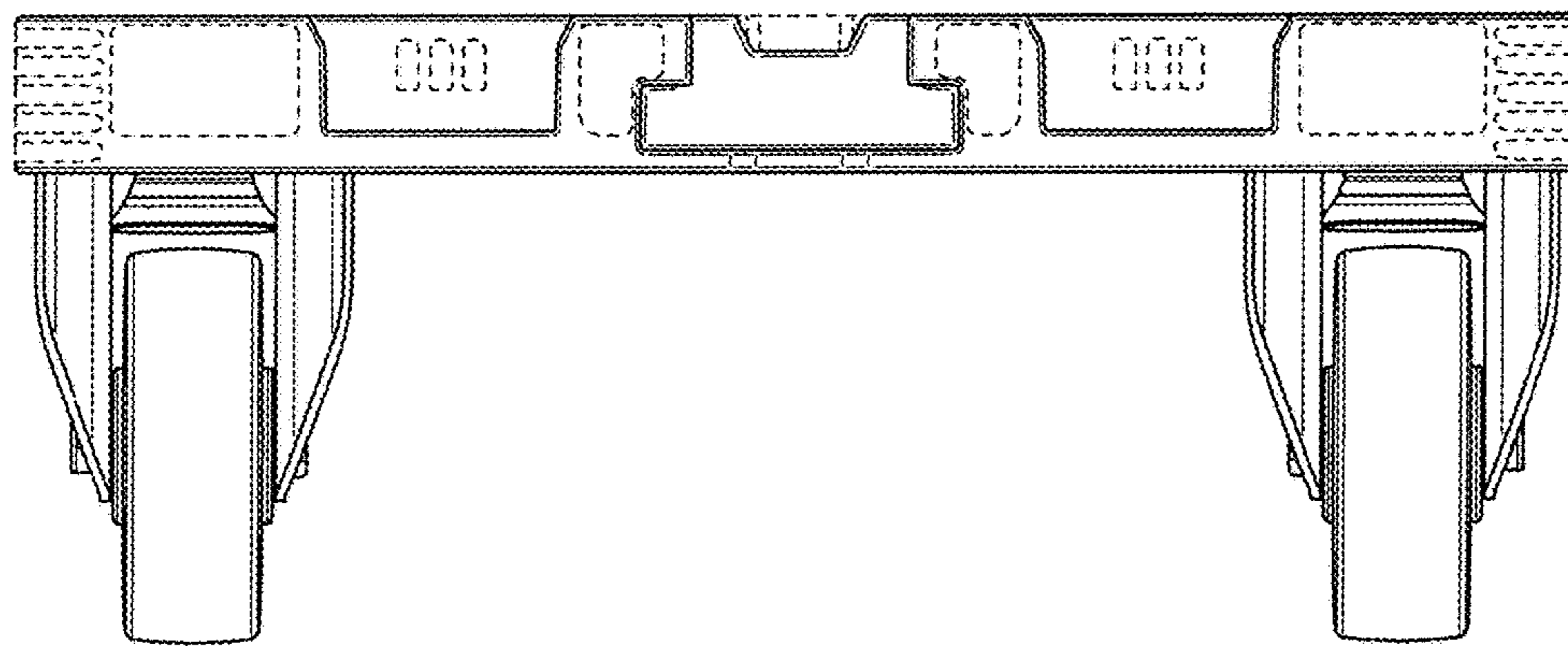

FIG. 4

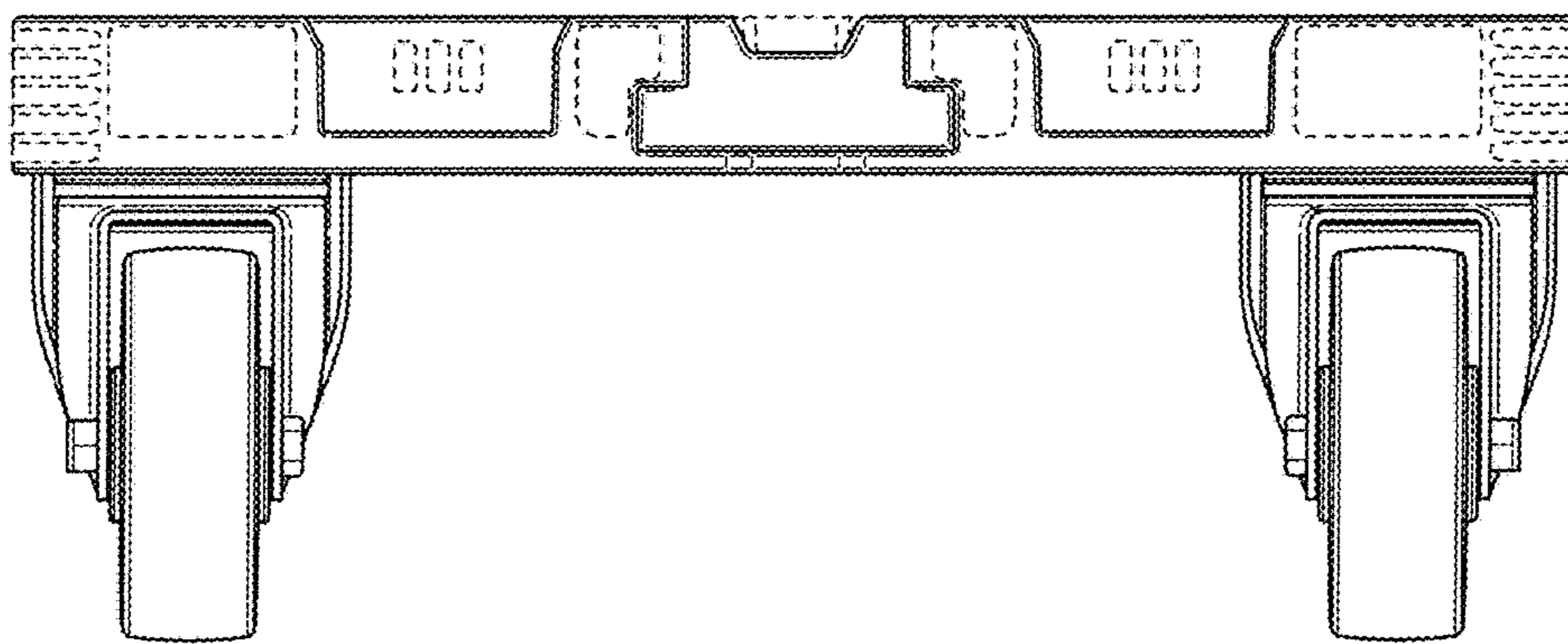

FIG. 5

FIG. 6

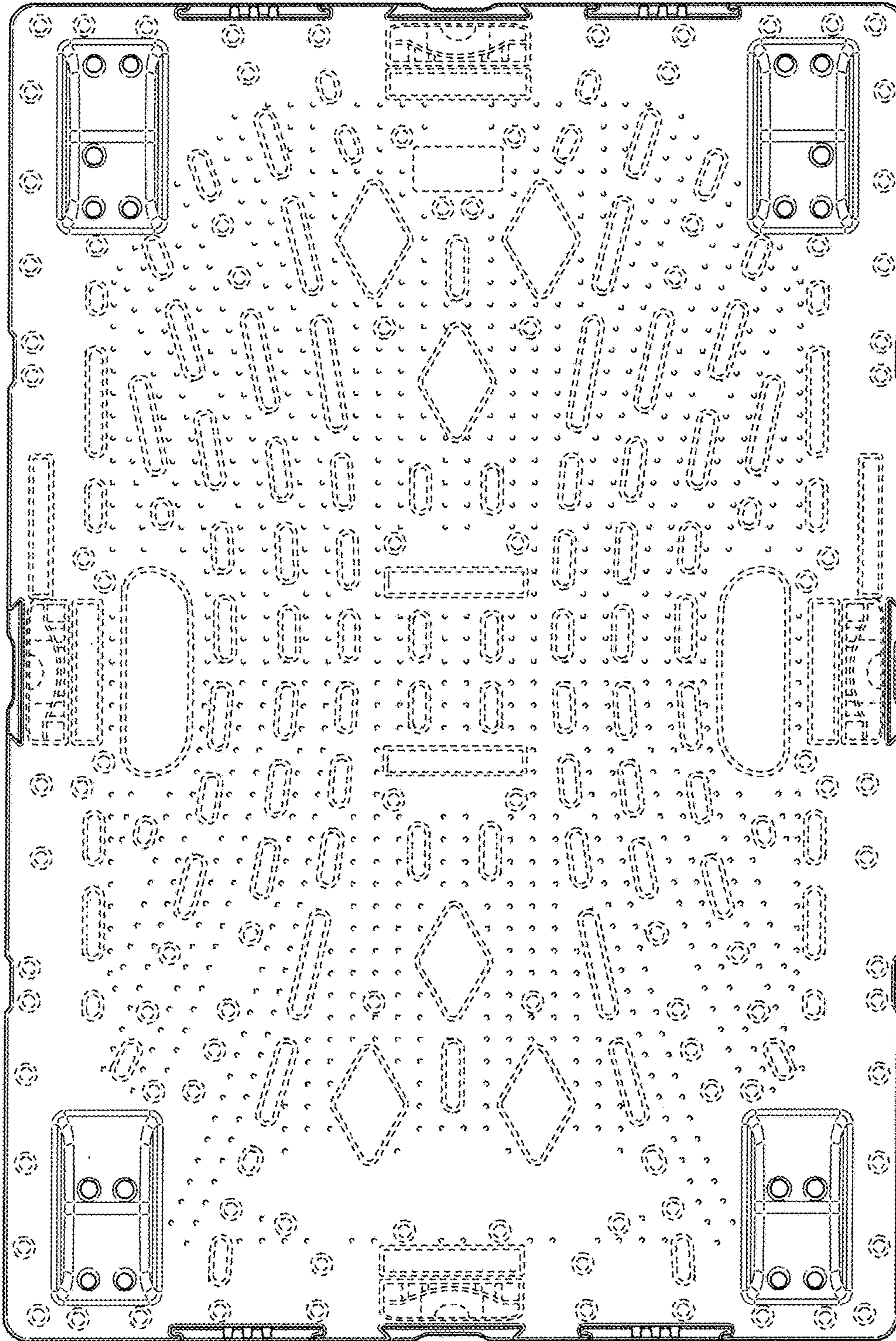



FIG. 7

