



US00D825847S

(12) **United States Design Patent**
Wissmann

(10) **Patent No.:** **US D825,847 S**

(45) **Date of Patent:** **** Aug. 14, 2018**

- (54) **PACKAGING FOR DETERGENT**
- (71) Applicant: **Henkel AG & Co. KGaA**, Duesseldorf (DE)
- (72) Inventor: **Guenter Wissmann**, Schenefeld (DE)
- (73) Assignee: **Henkel AG & Co. KGaA** (DE)
- (**) Term: **15 Years**
- (21) Appl. No.: **29/563,506**
- (22) Filed: **May 5, 2016**
- (30) **Foreign Application Priority Data**

Dec. 3, 2015 (EM) 002888669

- (51) **LOC (11) Cl.** **28-03**
- (52) **U.S. Cl.**
USPC **D28/8.1**
- (58) **Field of Classification Search**
USPC D28/4, 8.1-8.2
CPC . C11D 17/00; C11D 17/0017; C11D 17/0026;
C11D 17/0047-17/0095; C11D 13/18;
C11D 13/20; C11D 17/02
See application file for complete search history.

(56) **References Cited**

U.S. PATENT DOCUMENTS

D359,578 S *	6/1995	Hummel	D28/8.1
D445,673 S *	7/2001	Richardson	D28/8.1
D559,439 S *	1/2008	Schwartz	D28/8.1
D559,440 S *	1/2008	Schwartz	D28/8.1
D565,244 S *	3/2008	Schwartz	D28/8.1
D657,495 S *	4/2012	Davis	D28/8.1
D663,894 S *	7/2012	Davanzo	D28/8.1
D679,863 S *	4/2013	Sunder	D28/8.1
D735,407 S *	7/2015	Gerhards	D28/8.1

D777,373 S *	1/2017	Sunder	D28/8.1
D779,118 S *	2/2017	Johnson	D28/8.1
D779,119 S *	2/2017	Johnson	D28/8.1
D789,603 S *	6/2017	Rigobert	D28/8.1
2005/0227885 A1 *	10/2005	Maric	C11D 17/0095 510/141
2017/0057716 A1 *	3/2017	Fowler	B65D 65/46

* cited by examiner

Primary Examiner — Jennifer Rivard

(74) *Attorney, Agent, or Firm* — Thomas G. Krivulka

(57) **CLAIM**

I claim the ornamental design for packaging for detergent, as shown and described.

DESCRIPTION

FIG. 1 is a front perspective view of the first embodiment of packaging for detergent embodying my new design;
 FIG. 2 is a front side elevation view thereof;
 FIG. 3 is a rear side elevation view thereof;
 FIG. 4 is a right side elevation view thereof;
 FIG. 5 is a left side elevation view thereof;
 FIG. 6 is a top plan view thereof;
 FIG. 7 is a bottom plan view thereof;
 FIG. 8 is a front perspective view of the second embodiment of packaging for detergent embodying my new design;
 FIG. 9 is a front side elevation view thereof;
 FIG. 10 is a rear side elevation view thereof;
 FIG. 11 is a right side elevation view thereof;
 FIG. 12 is a left side elevation view thereof;
 FIG. 13 is a top plan view thereof; and,
 FIG. 14 is a bottom plan view thereof.
 The broken lines illustrate portions of the packaging for detergent and form no part of the claimed design.

1 Claim, 8 Drawing Sheets

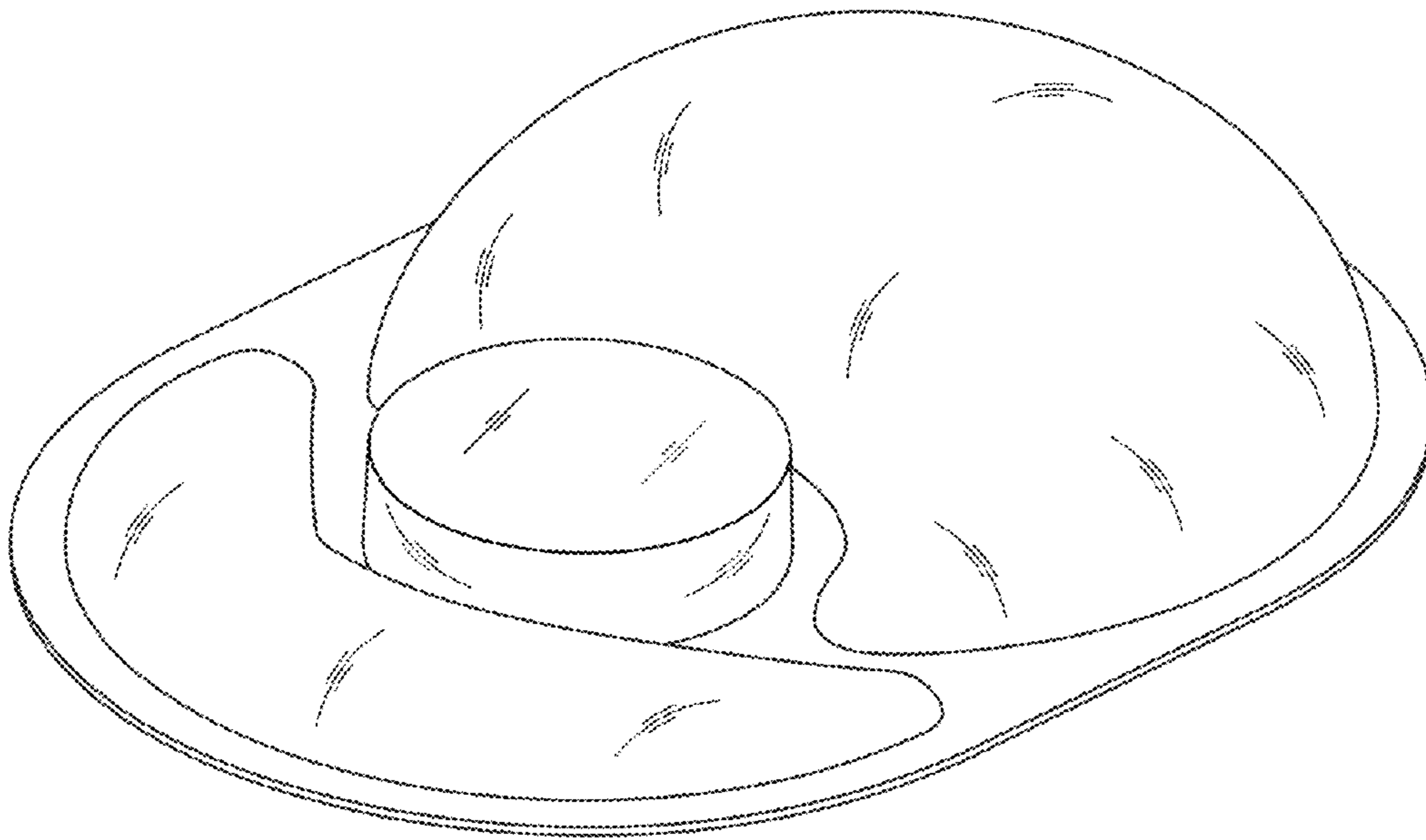

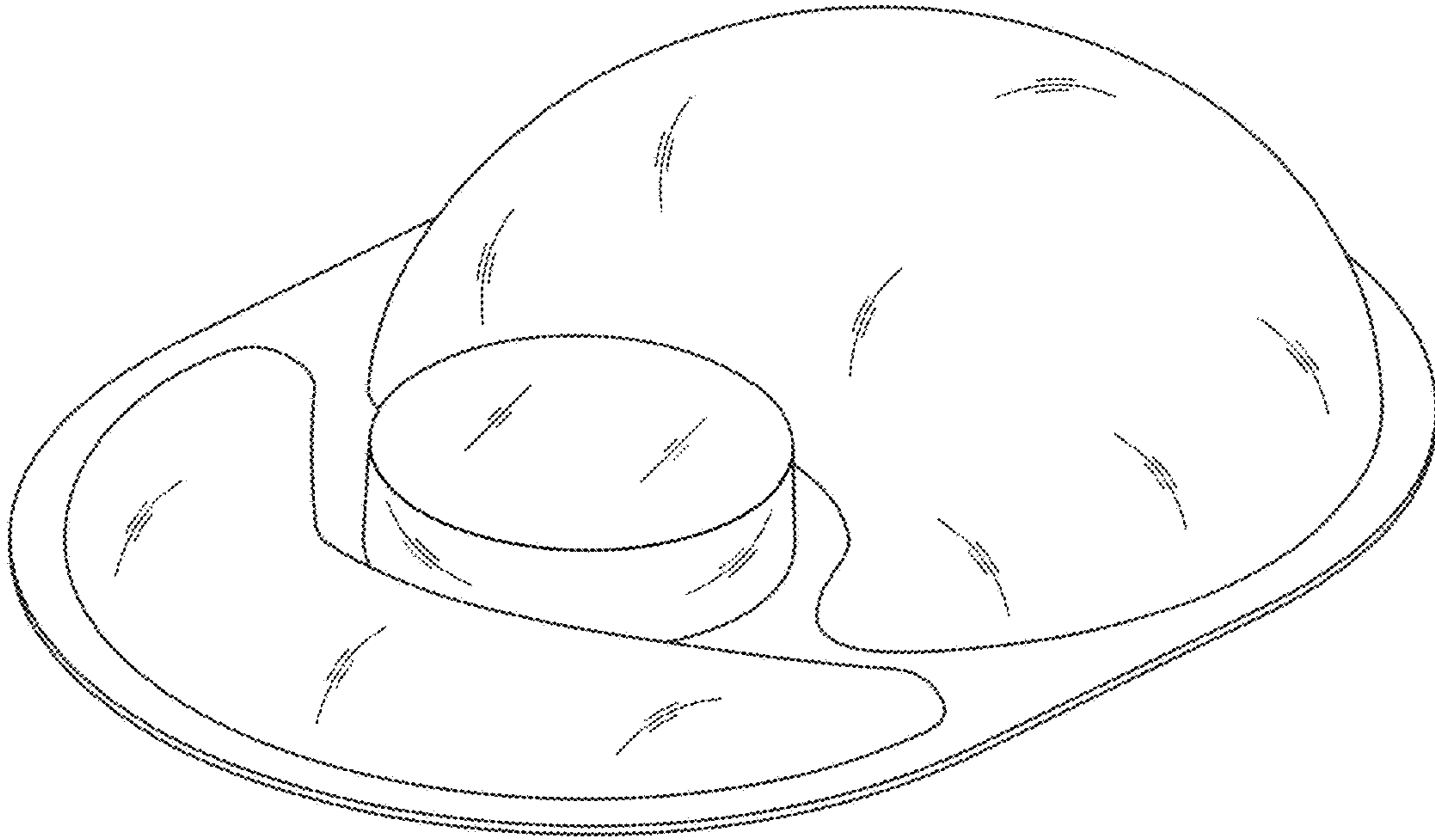

FIG. 1

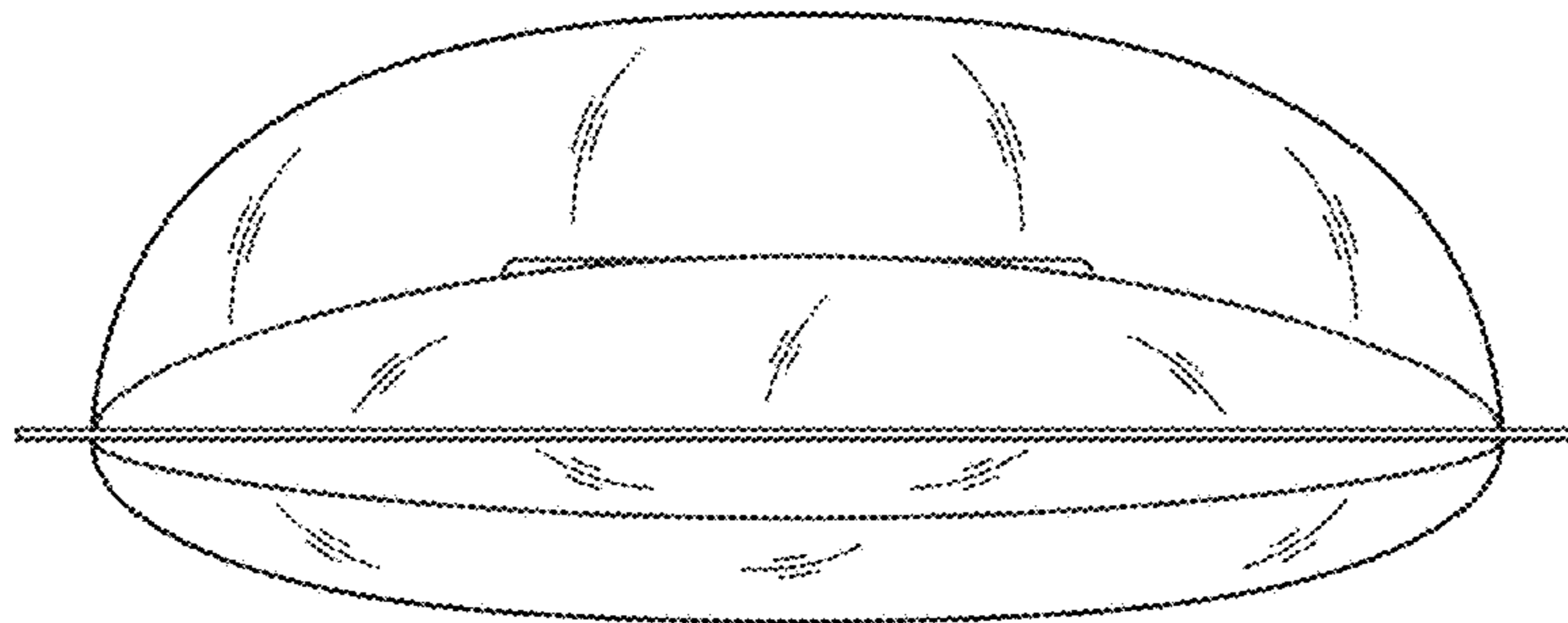

FIG. 2

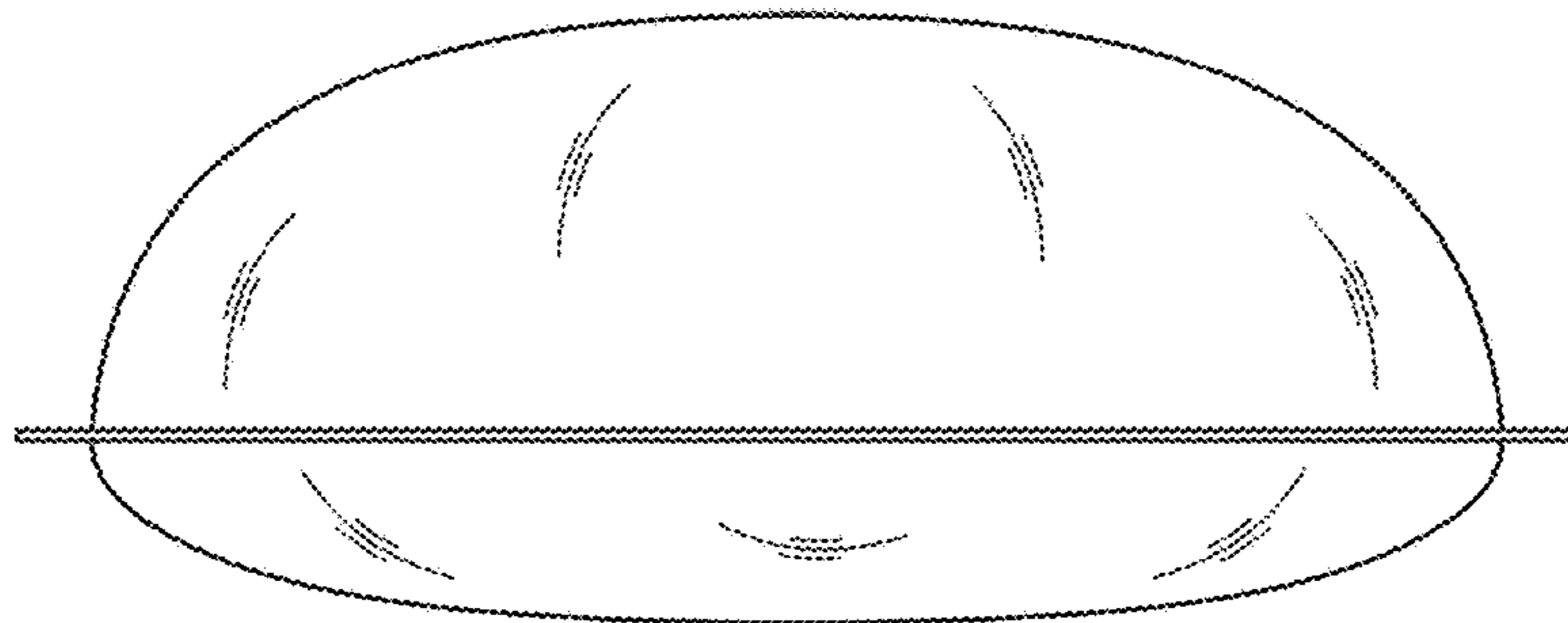

FIG. 3

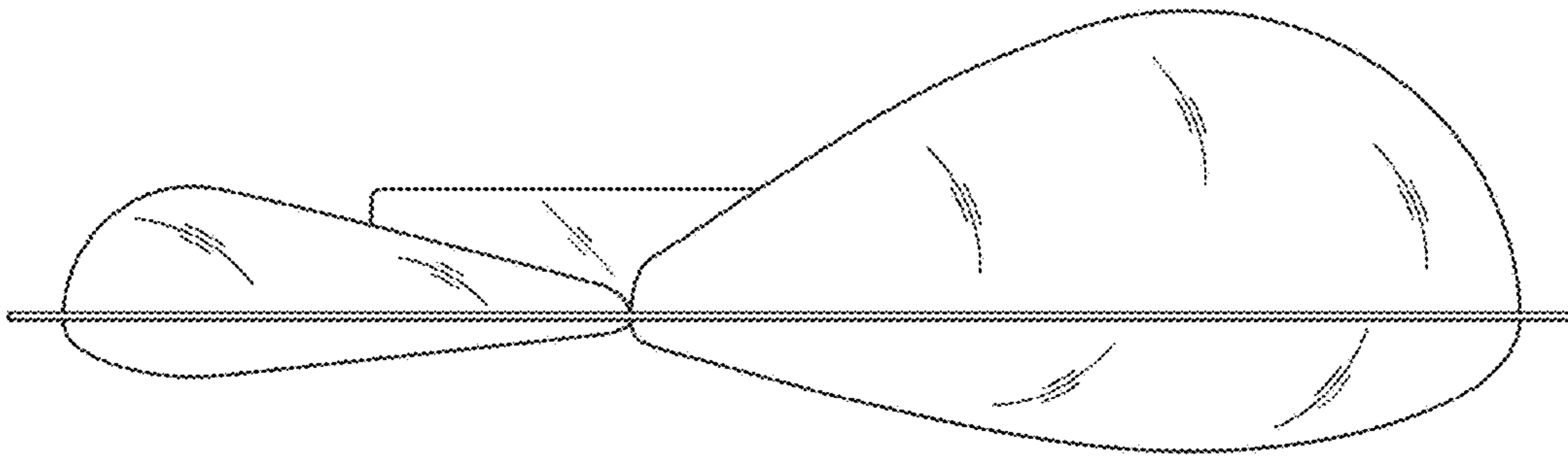

FIG. 4

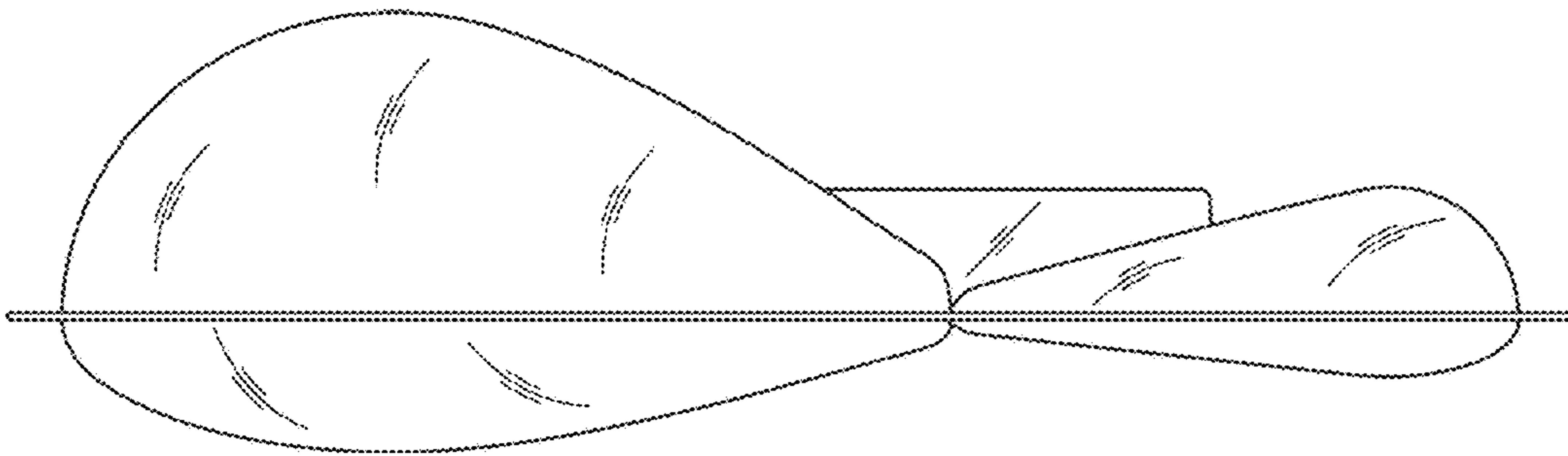

FIG. 5

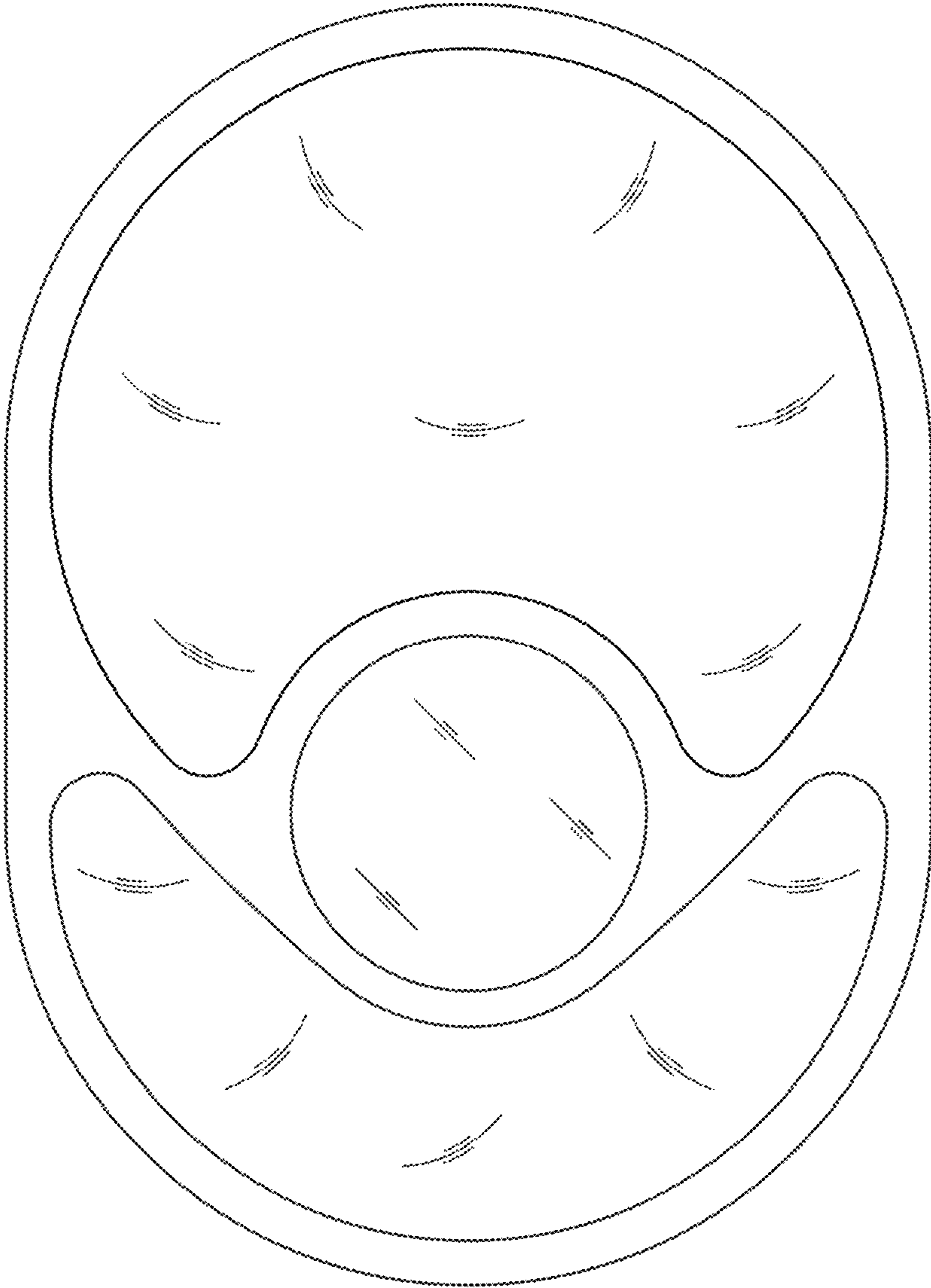

FIG. 6

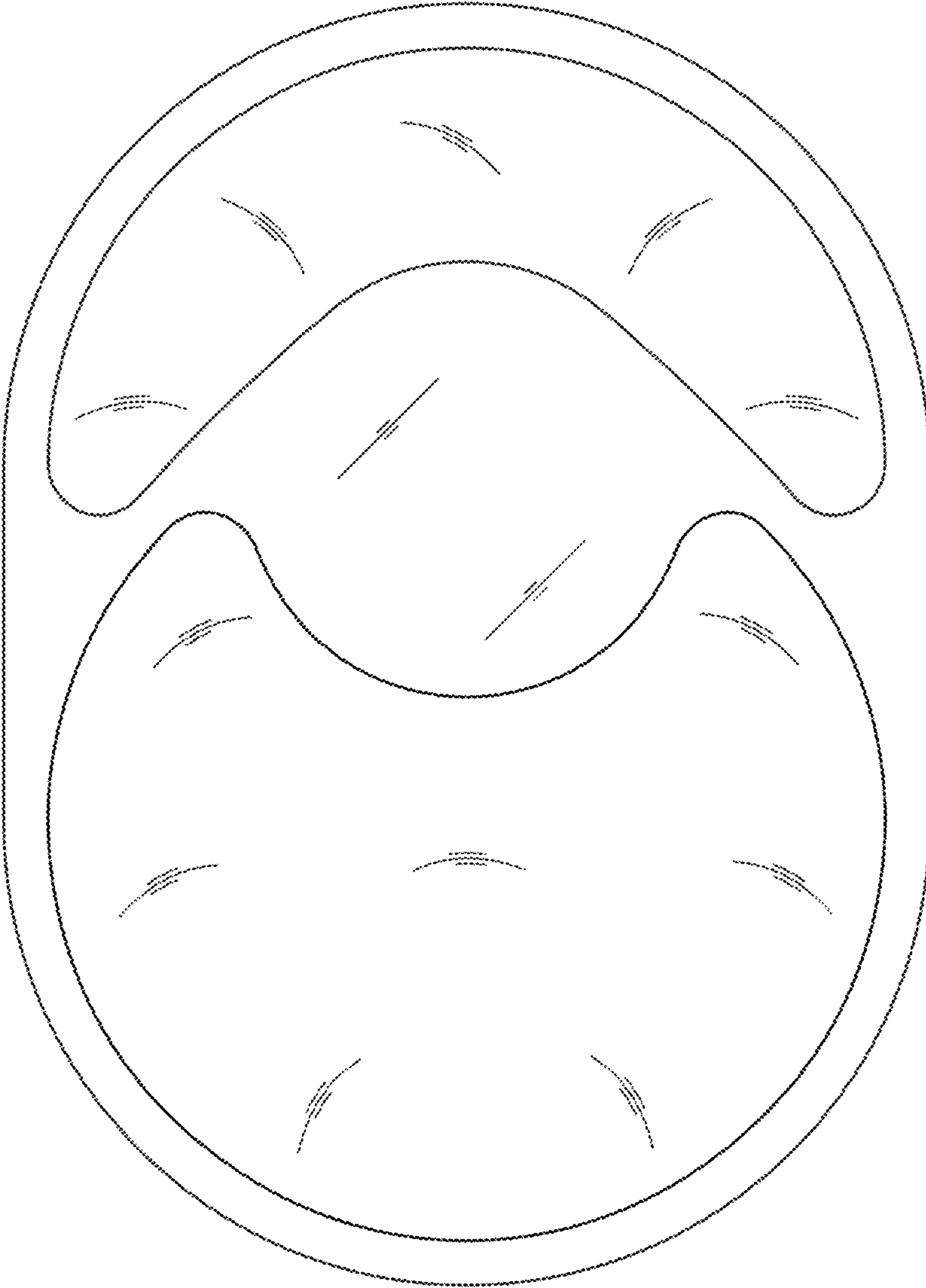

FIG. 7

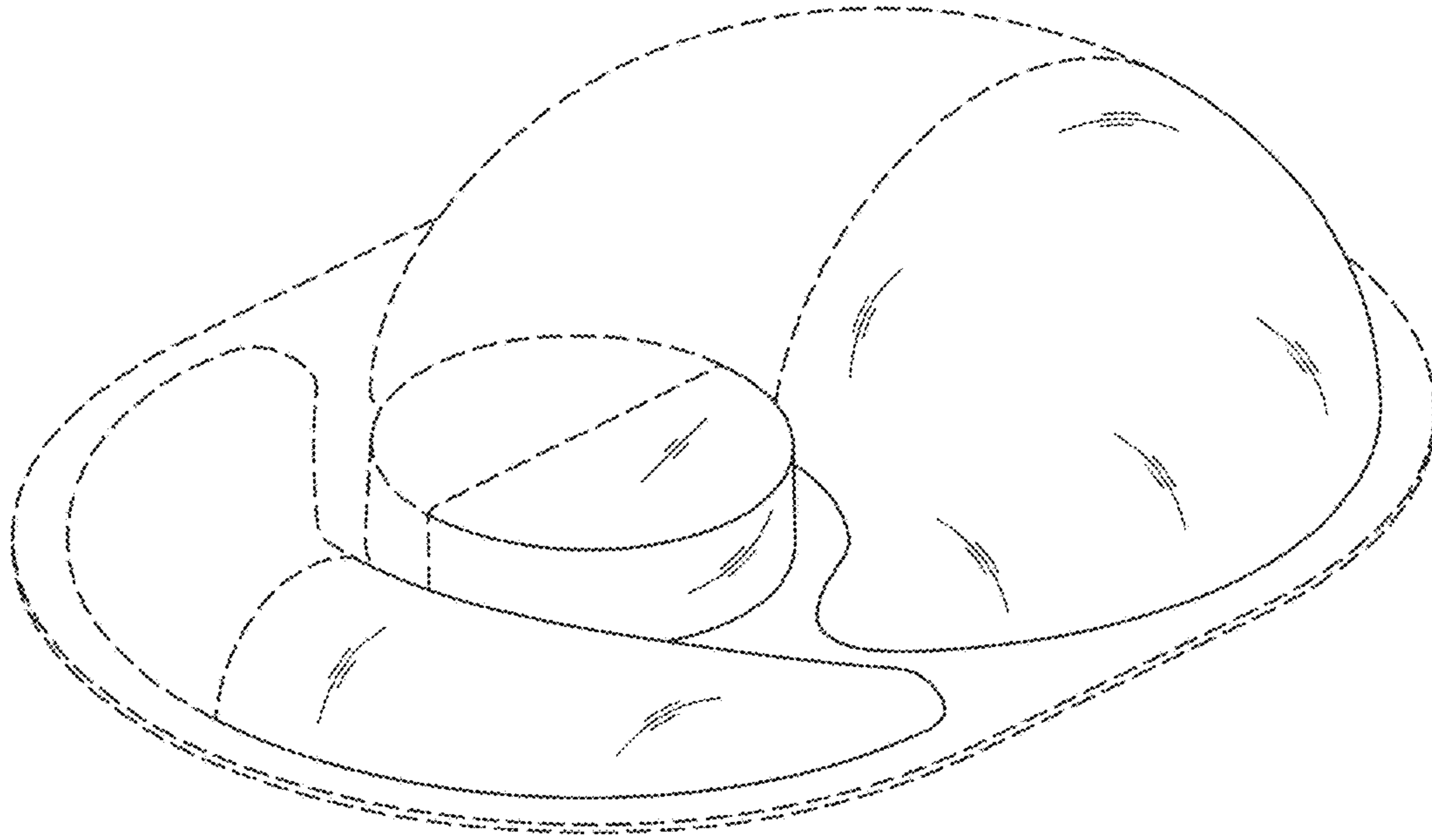

FIG. 8

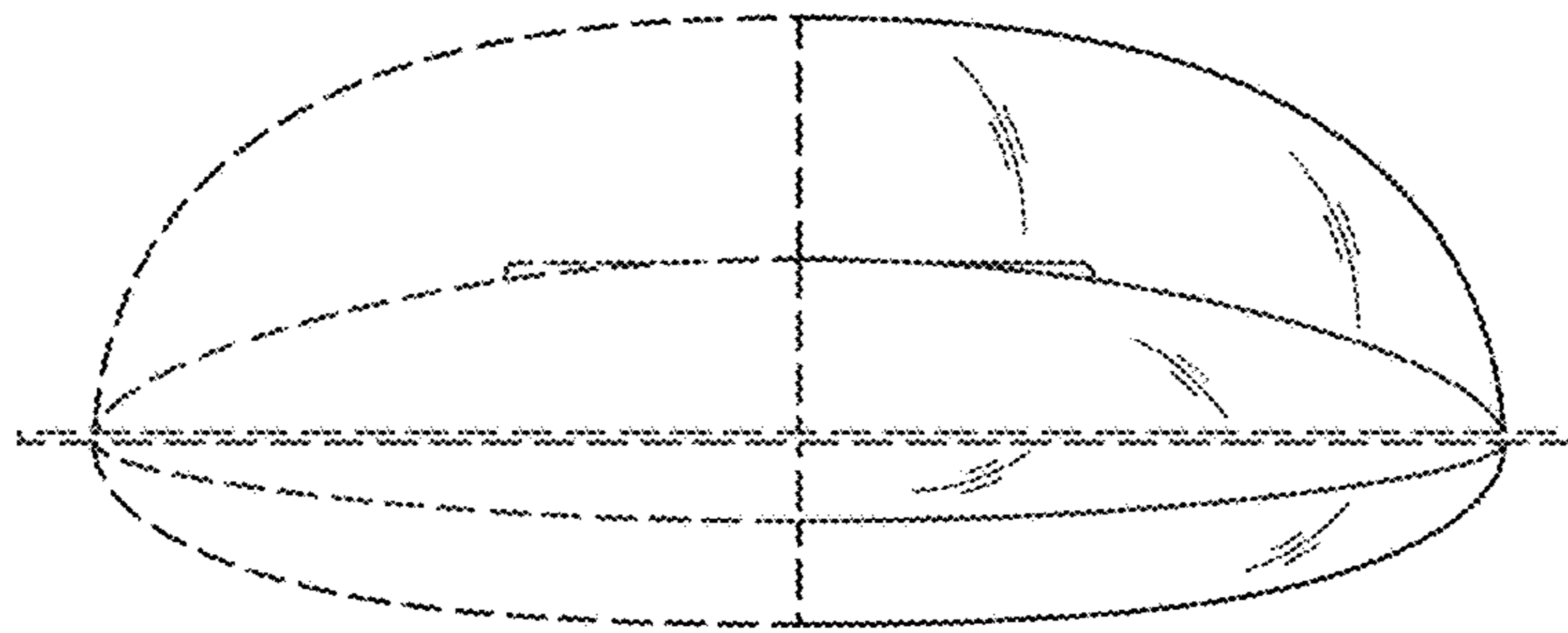

FIG. 9

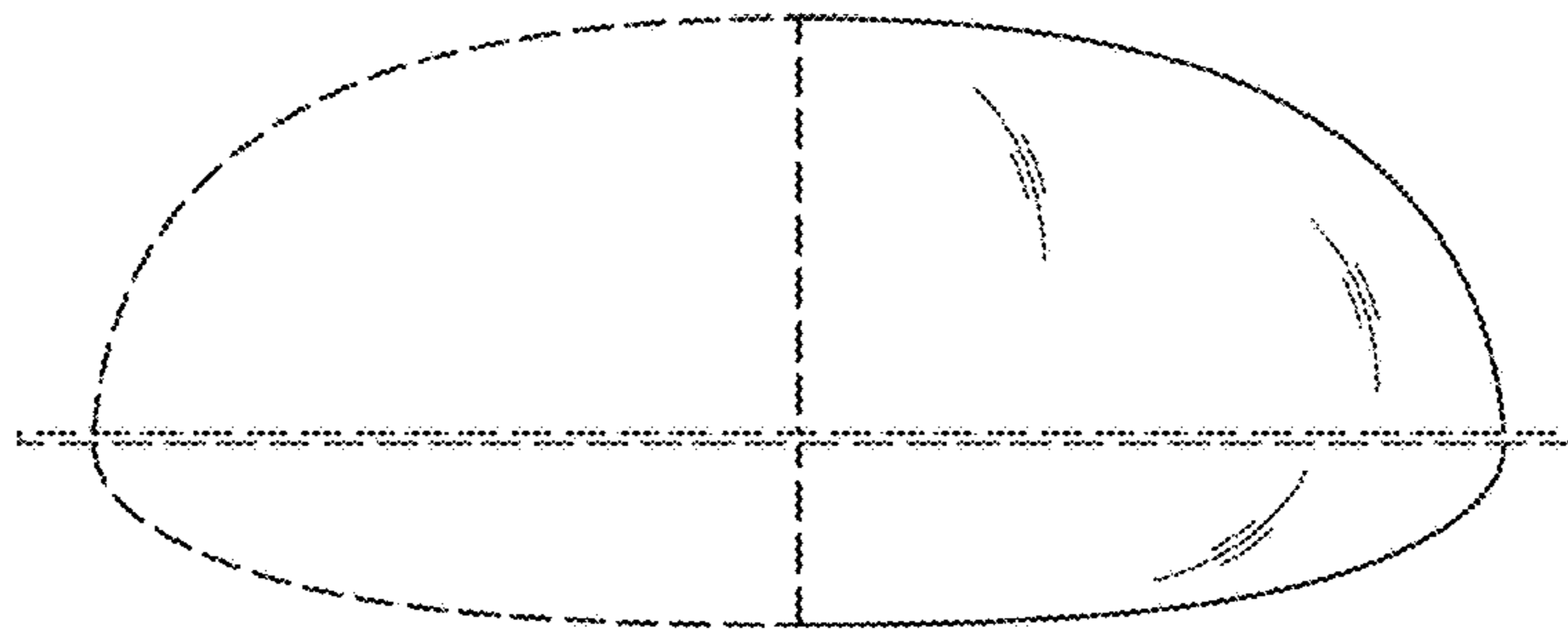

FIG. 10

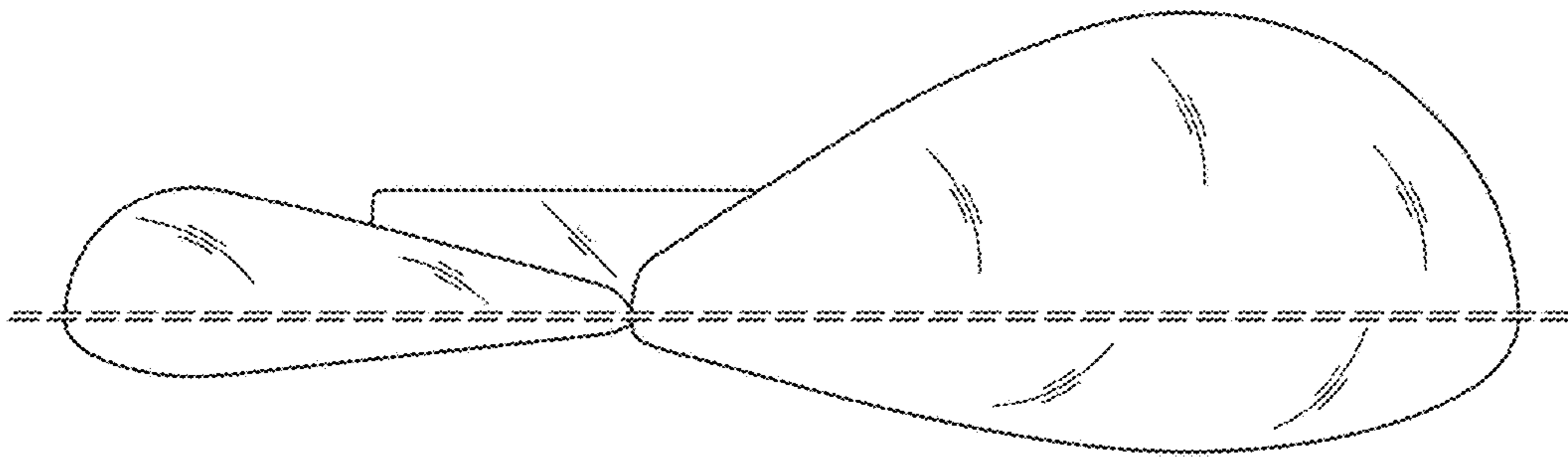

FIG. 11

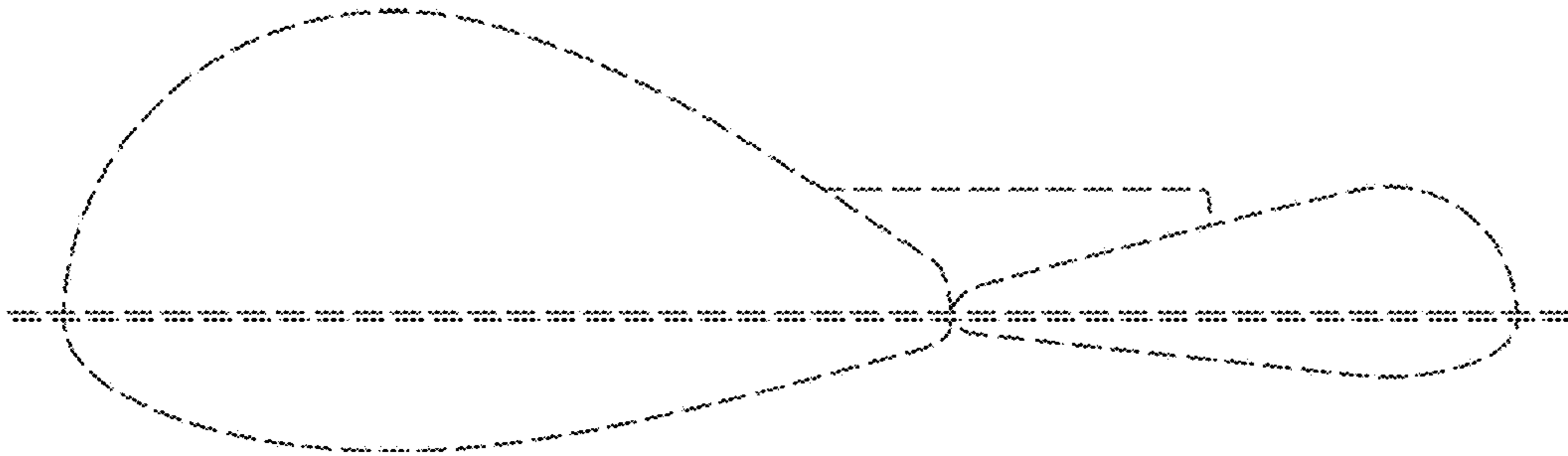

FIG. 12

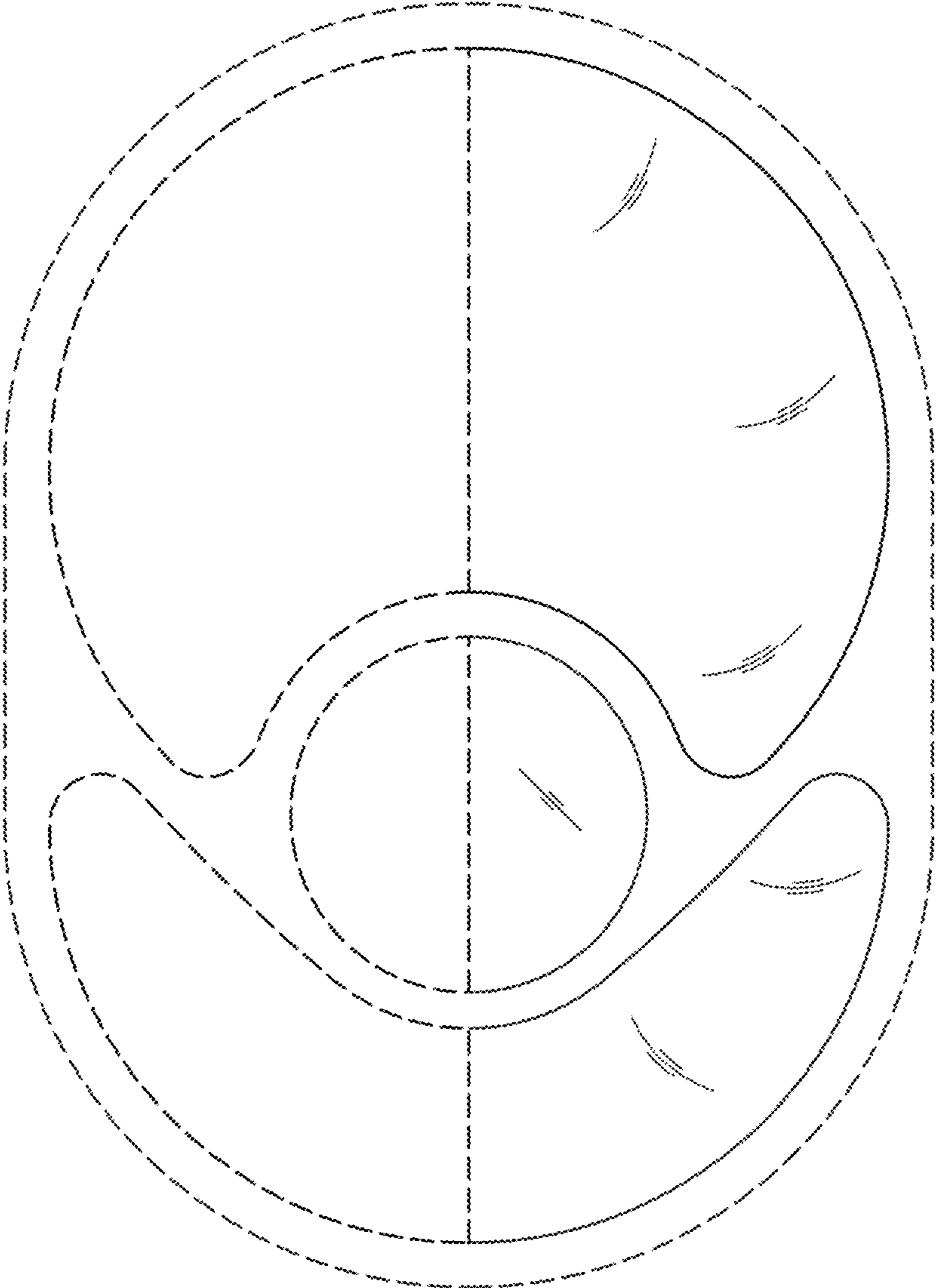

FIG. 13

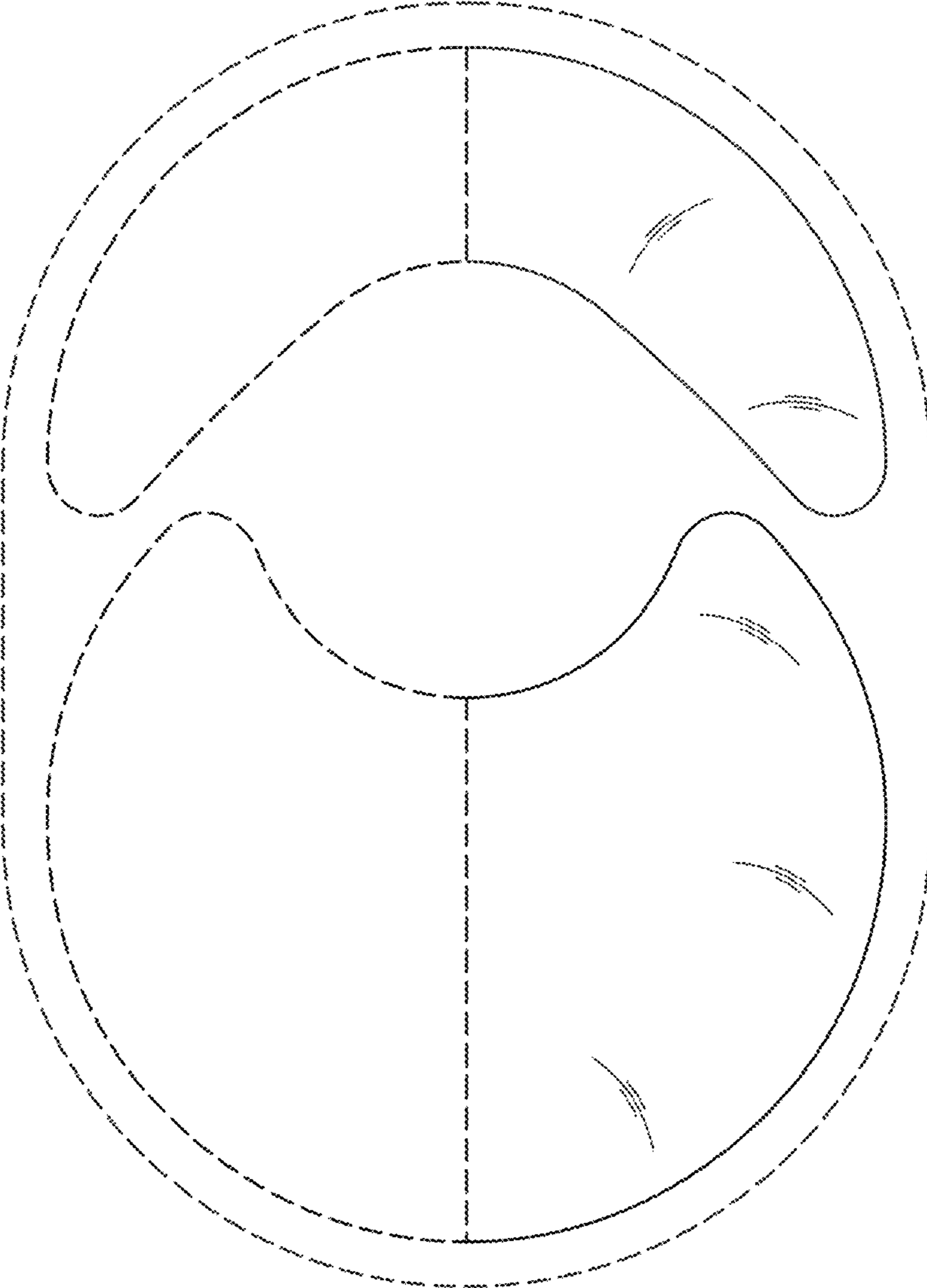

FIG. 14