



US00D825819S

(12) **United States Design Patent** (10) **Patent No.:** **US D825,819 S**
Sonneman (45) **Date of Patent:** **** Aug. 14, 2018**

(54) **LIGHT FIXTURE**

(71) Applicant: **Robert A. Sonneman**, Mamaroneck, NY (US)

(72) Inventor: **Robert A. Sonneman**, Mamaroneck, NY (US)

(73) Assignee: **Contemporary Visions, LLC**, Larchmont, NY (US)

(**) Term: **15 Years**

(21) Appl. No.: **29/629,589**

(22) Filed: **Dec. 14, 2017**

(51) **LOC (11) Cl.** **26-03**

(52) **U.S. Cl.**
USPC **D26/90**

(58) **Field of Classification Search**
USPC ... D26/3, 26, 72, 75, 76, 78, 80, 81, 82, 84, D26/86, 88, 90, 91, 113
CPC .. F21S 2/005; F21S 4/002; F21S 4/008; F21S 8/031; F21S 8/038; F21S 8/04; F21S 8/043; F21S 8/046; F21S 8/06; F21S 8/061; F21S 8/063; F21S 8/065; F21S 8/066; F21S 8/068

See application file for complete search history.

(56) **References Cited**

U.S. PATENT DOCUMENTS

D500,878 S *	1/2005	Lewis	D26/76
D664,282 S *	7/2012	Santoro	D26/76
D669,209 S *	10/2012	Choi	D26/90
D669,625 S *	10/2012	Herremans	D26/90
D700,989 S *	3/2014	Rampolla	D26/88
D776,855 S *	1/2017	Rashid	D26/76

D777,366 S *	1/2017	Kitts	D26/88
D786,483 S	5/2017	Sonneman	
D806,927 S *	1/2018	Rashid	D26/76
D810,966 S *	2/2018	Zhou	D26/3
2013/0107519 A1*	5/2013	Kim	F21V 3/0625 362/235
2017/0074495 A1*	3/2017	Skergeth	F21V 15/01

* cited by examiner

Primary Examiner — Clare E Heflin

(74) *Attorney, Agent, or Firm* — Gottlieb, Rackman & Reisman, P.C.

(57) **CLAIM**

The ornamental design for a light fixture, as shown and described.

DESCRIPTION

FIG. 1 is a perspective view of a light fixture showing my new design;
FIG. 2 is a front elevational view thereof;
FIG. 3 is a rear elevational view thereof;
FIG. 4 is a right side elevational view thereof;
FIG. 5 is a left side elevational view thereof;
FIG. 6 is a top plan view thereof;
FIG. 7 is a bottom plan view thereof;
FIG. 8 is an enlarged perspective view thereof;
FIG. 9 is a front elevational view of FIG. 8;
FIG. 10 is a rear elevational view of FIG. 8;
FIG. 11 is a right side elevational view of FIG. 8;
FIG. 12 is a left side elevational view of FIG. 8;
FIG. 13 is a top plan view of FIG. 8; and,
FIG. 14 is a bottom plan view of FIG. 8.

The broken lines shown in the drawings are included for the purpose of illustrating portions of the light fixture that form no part of the claimed design.

1 Claim, 9 Drawing Sheets

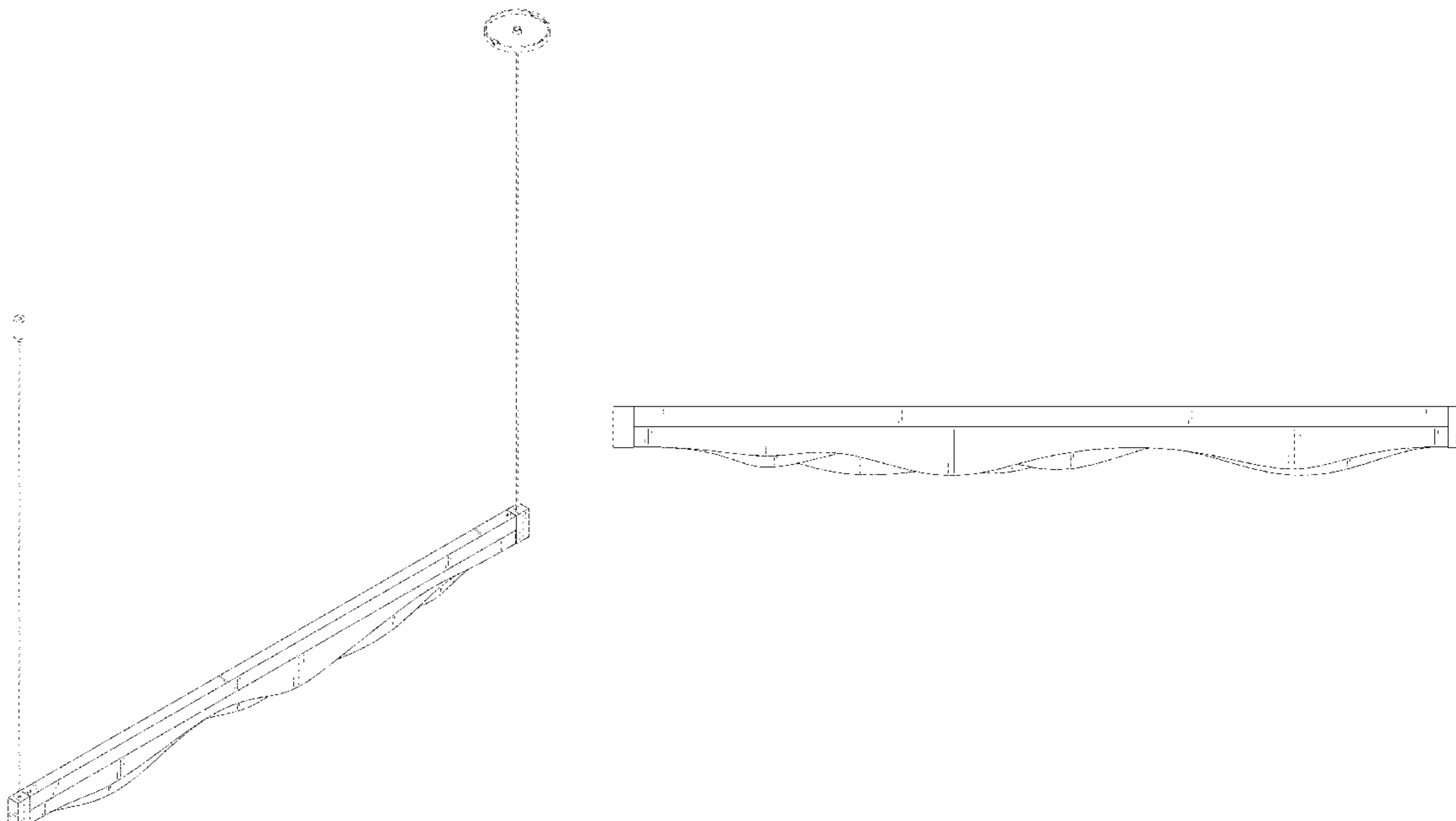

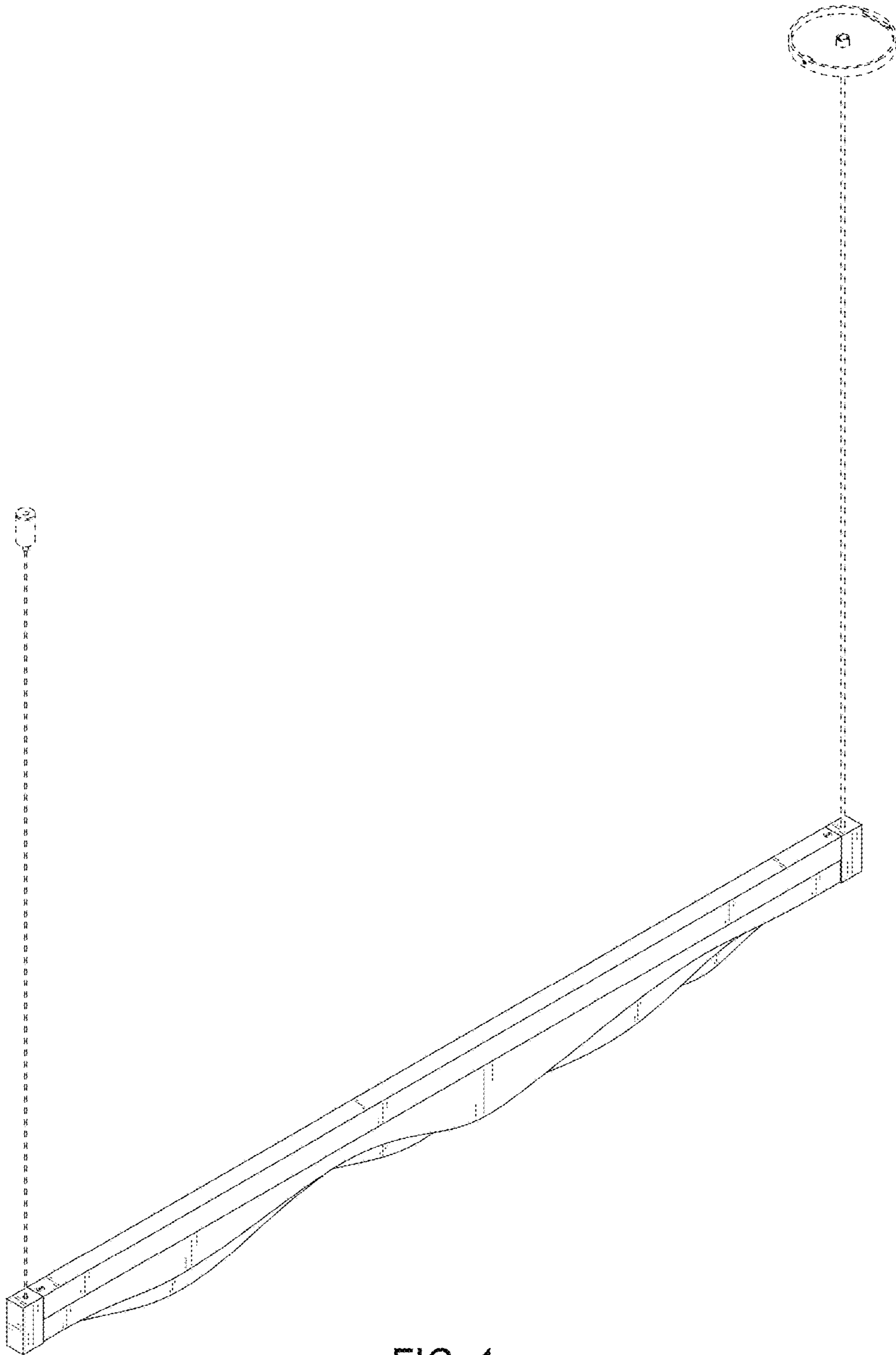
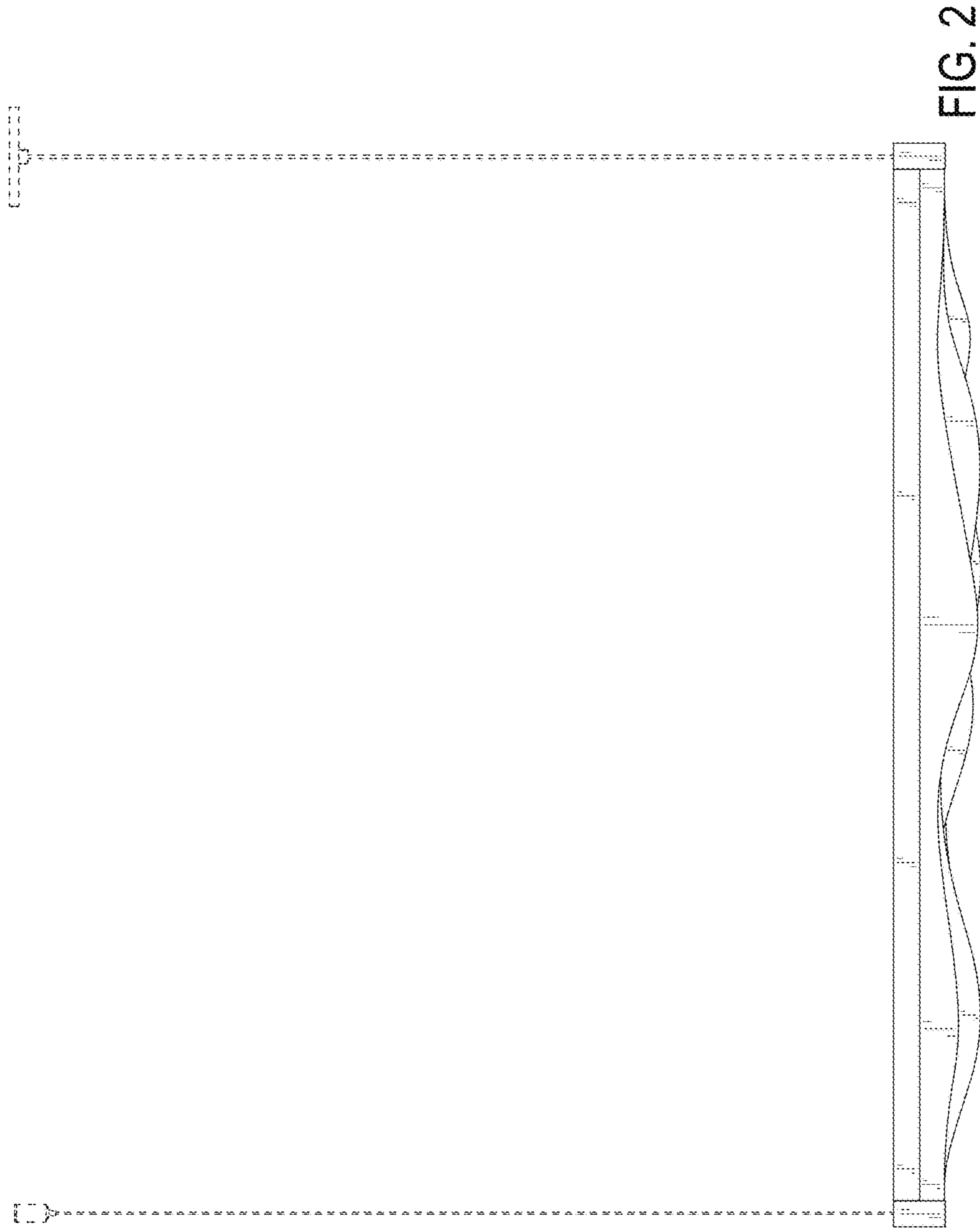
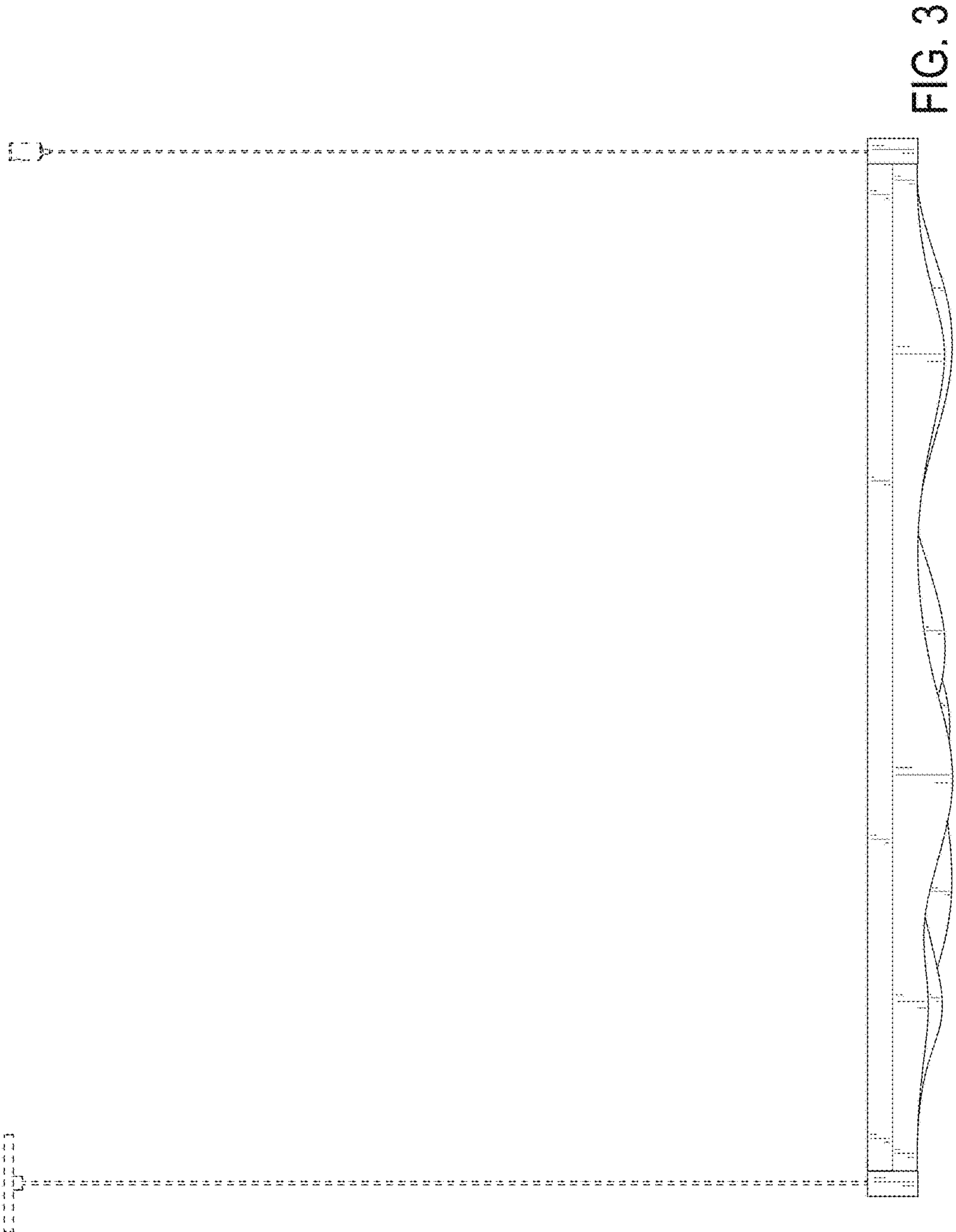

FIG. 1





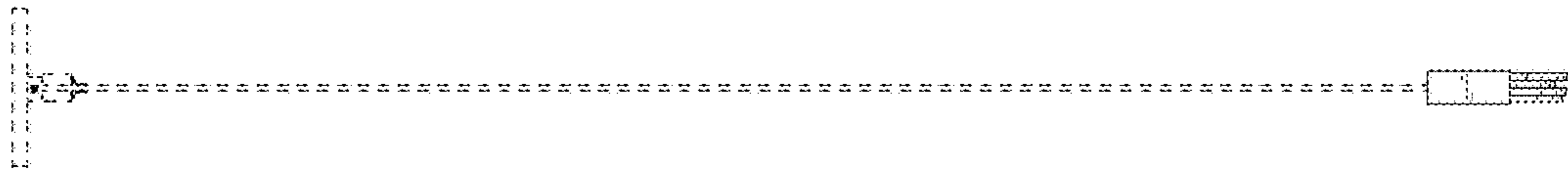

FIG. 5

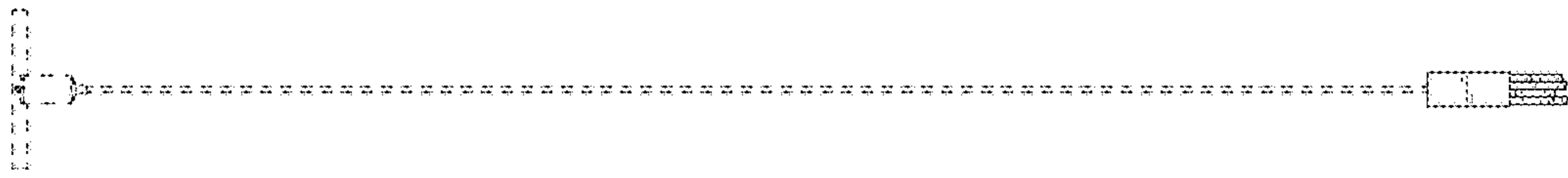

FIG. 4



FIG. 6



FIG. 7



FIG. 8

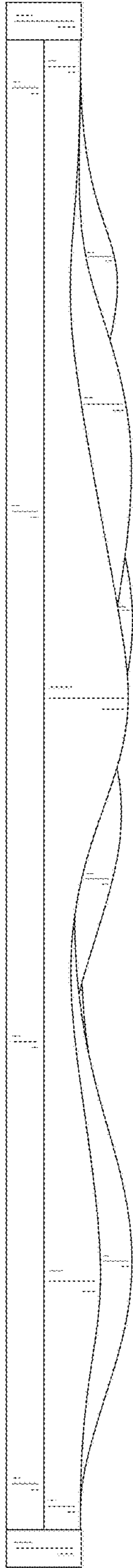

FIG. 9

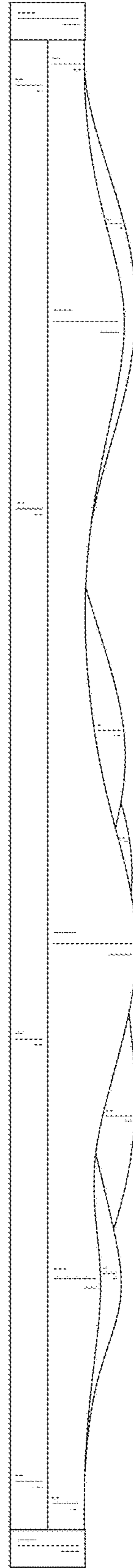

FIG. 10

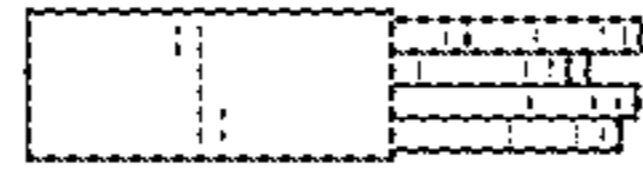

FIG. 11

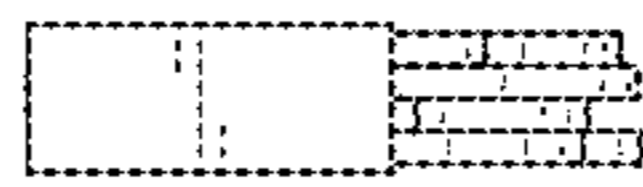

FIG. 12



FIG. 13

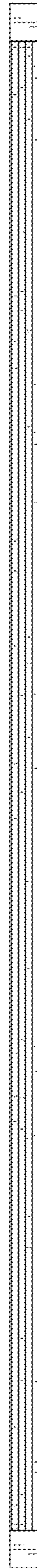

FIG. 14