



US00D825738S

(12) **United States Design Patent** (10) **Patent No.:** **US D825,738 S**
Mitchell (45) **Date of Patent:** **** Aug. 14, 2018**

(54) **HANDHELD RESPIRATORY DEVICE**

(56) **References Cited**

(71) Applicant: **KONINKLIJKE PHILIPS N.V.**,
Eindhoven (NL)

U.S. PATENT DOCUMENTS

(72) Inventor: **Andrew Mitchell**, Eindhoven (NL)

D207,143 S *	3/1967	Goodwin	D24/110
D461,239 S *	8/2002	Cassidy	D24/110
D479,745 S *	9/2003	Albulet	D24/110
D620,588 S *	7/2010	Nielsen	D24/110
D635,242 S *	3/2011	Adamo	D24/110
D681,804 S *	5/2013	Sheehy	D24/110
D783,806 S *	4/2017	Milton-Edwards	D24/110
D783,807 S *	4/2017	Fosbury	D24/110

(73) Assignee: **KONINKLIJKE PHILIPS N.V.**,
Eindhoven (NL)

(**) Term: **15 Years**

* cited by examiner

(21) Appl. No.: **35/501,770**

Primary Examiner — Manpreet S Matharu

(22) Filed: **Apr. 27, 2016**

Assistant Examiner — Eliza Z Bennett-Hattan

(80) **Hague Agreement Data**

(57) **CLAIM**

Int. Filing Date: **Apr. 27, 2016**

The ornamental design for a handheld respiratory device, as shown and described.

Int. Reg. No.: **DM/090489**

Int. Reg. Date: **Apr. 27, 2016**

Int. Reg. Pub. Date: **Oct. 28, 2016**

DESCRIPTION

(30) **Foreign Application Priority Data**

Nov. 19, 2015 (EM) 002870089-0001

(51) **LOC (11) Cl.** **29-02**

(52) **U.S. Cl.**
USPC **D24/110**

(58) **Field of Classification Search**
USPC D24/110, 133, 137, 138, 110.5, 110.6
CPC A61M 15/009; A61M 2202/0007; A61M
15/0065; A61M 15/0091; A61M 11/00;
A61M 15/0086; A61M 2205/586; A61M
15/002; A61M 2205/3331

- 1. Handheld respiratory device
- 1.1 is a perspective view showing the handheld respiratory device of my design.
- 1.2 is a front elevational view thereof;
- 1.3 is a rear elevational view thereof;
- 1.4 is a left side elevational view thereof;
- 1.5 is a right side elevational view thereof;
- 1.6 is a top plan view thereof; and,
- 1.7 is a bottom plan view thereof.

The portions of the handheld respiratory device shown in broken lines are included for the purpose of illustrating unclaimed portions of the handheld respiratory device and form no part of the claimed design.

The unshaded surfaces form no part of the claim.

See application file for complete search history.

1 Claim, 6 Drawing Sheets

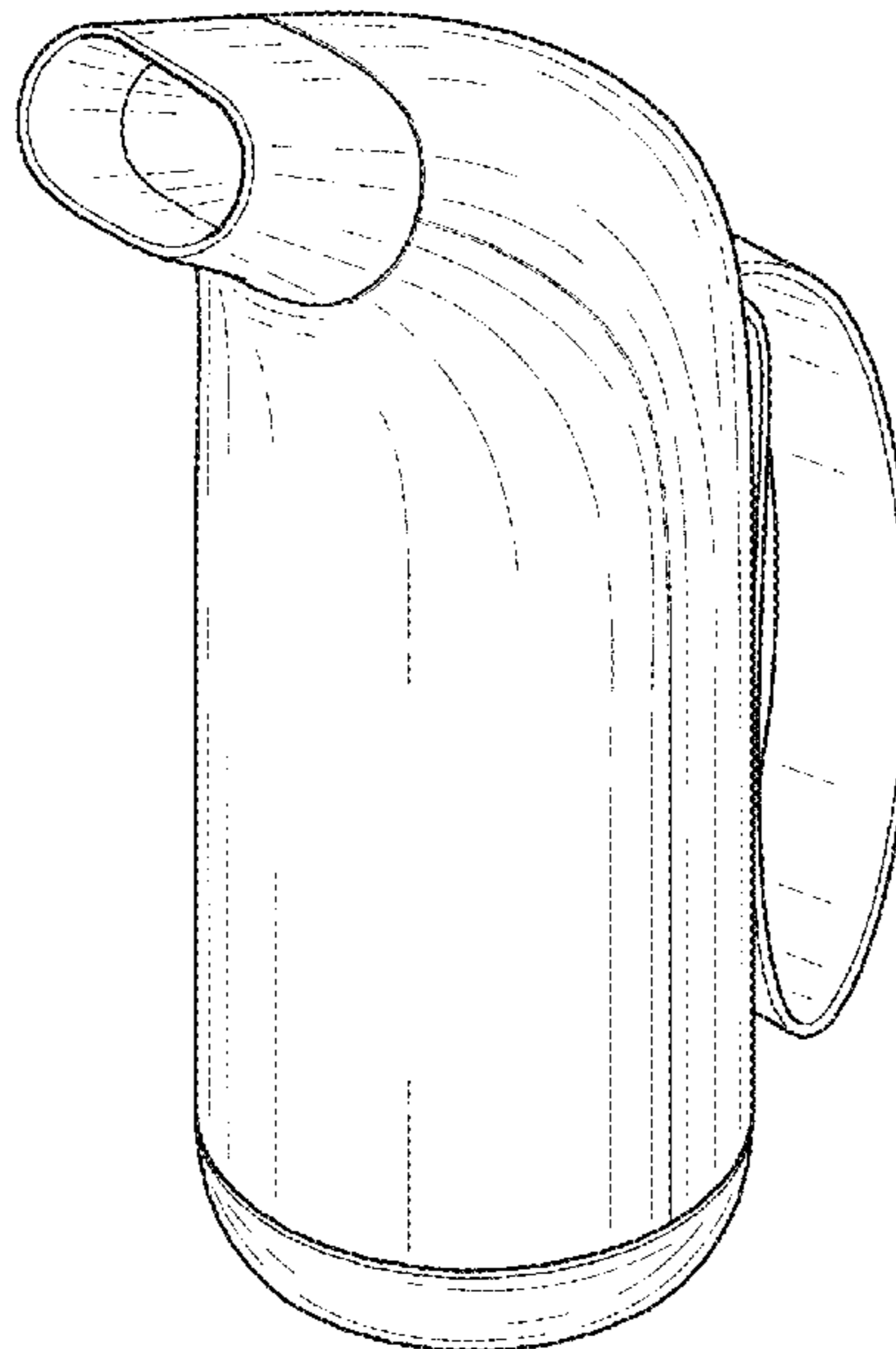

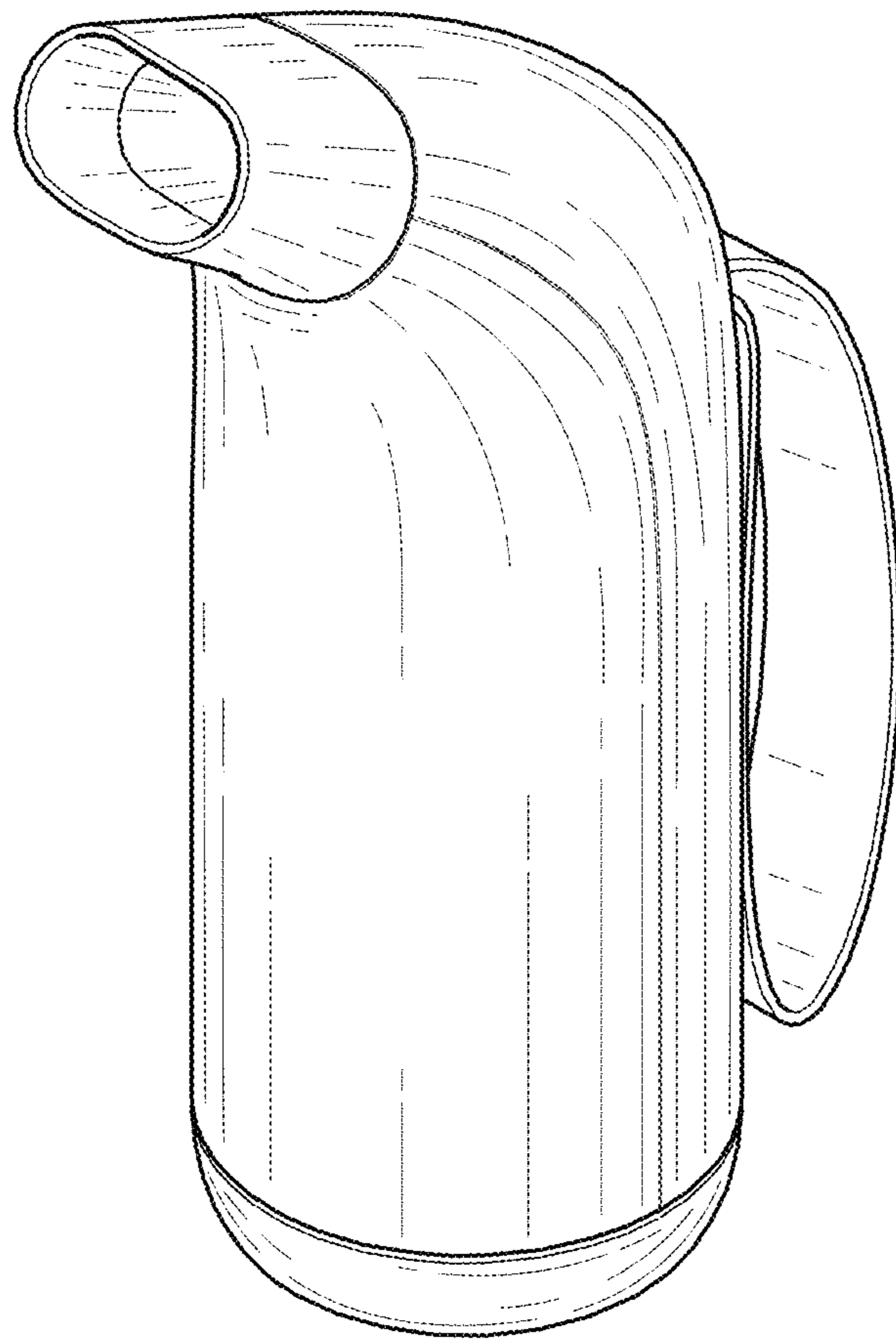

1.1

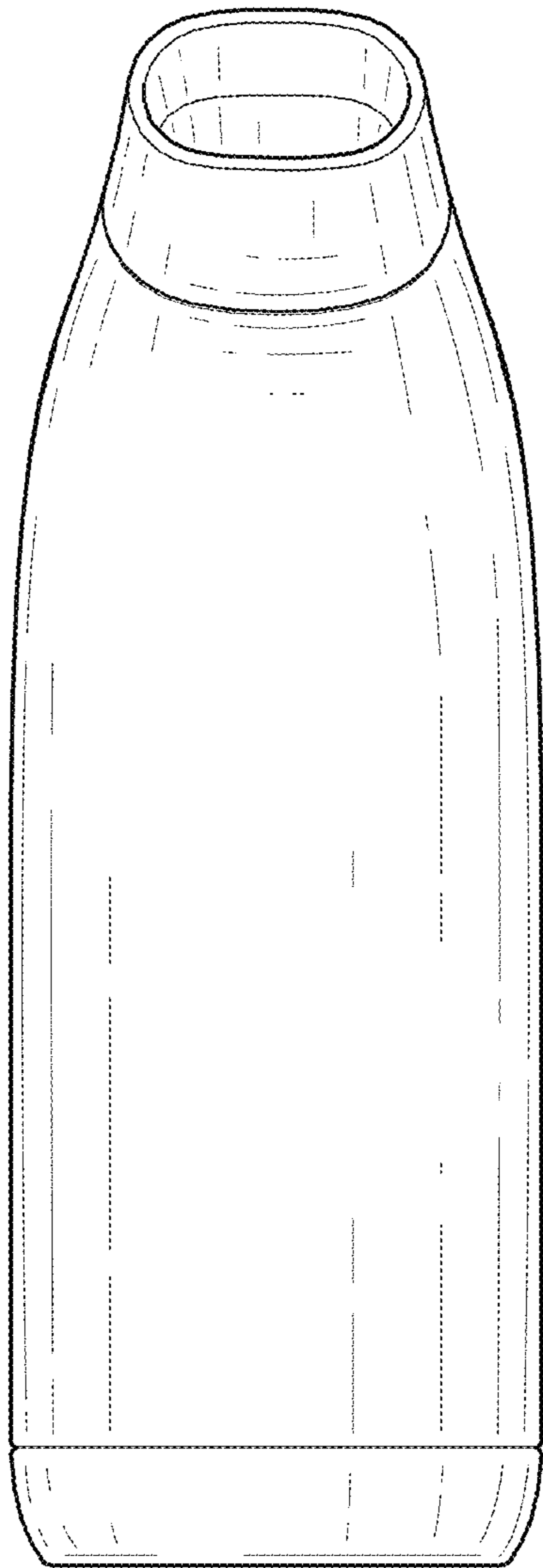

1.2

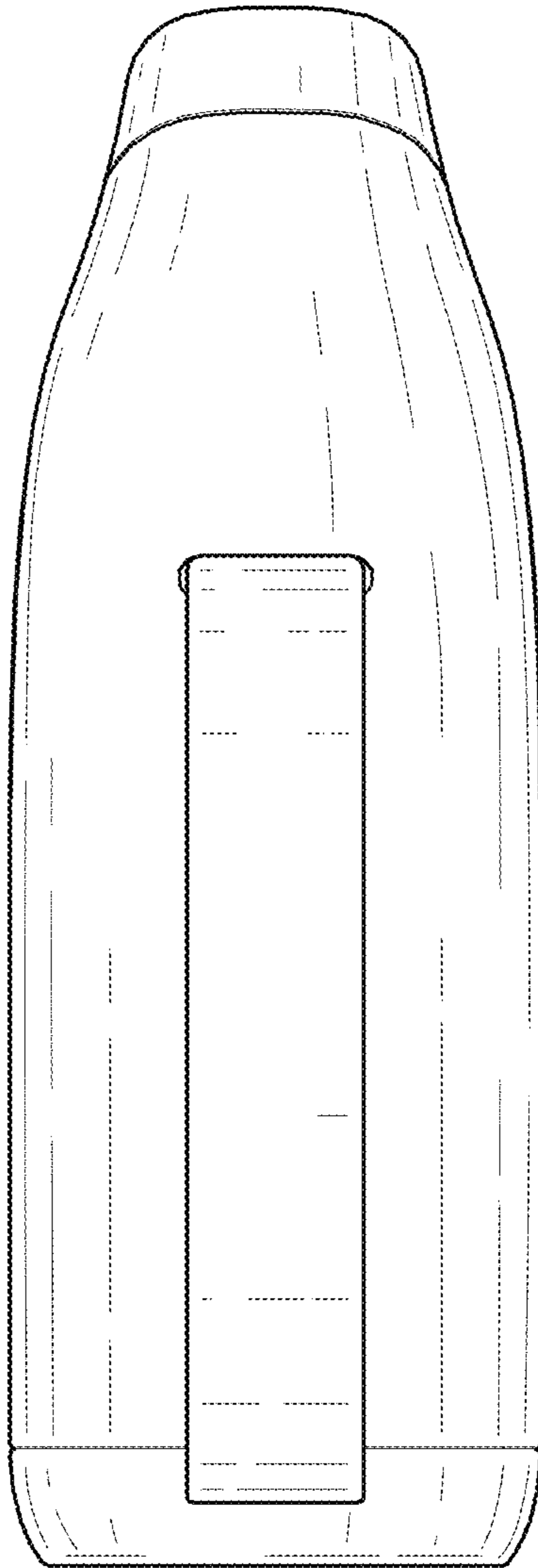

1.3

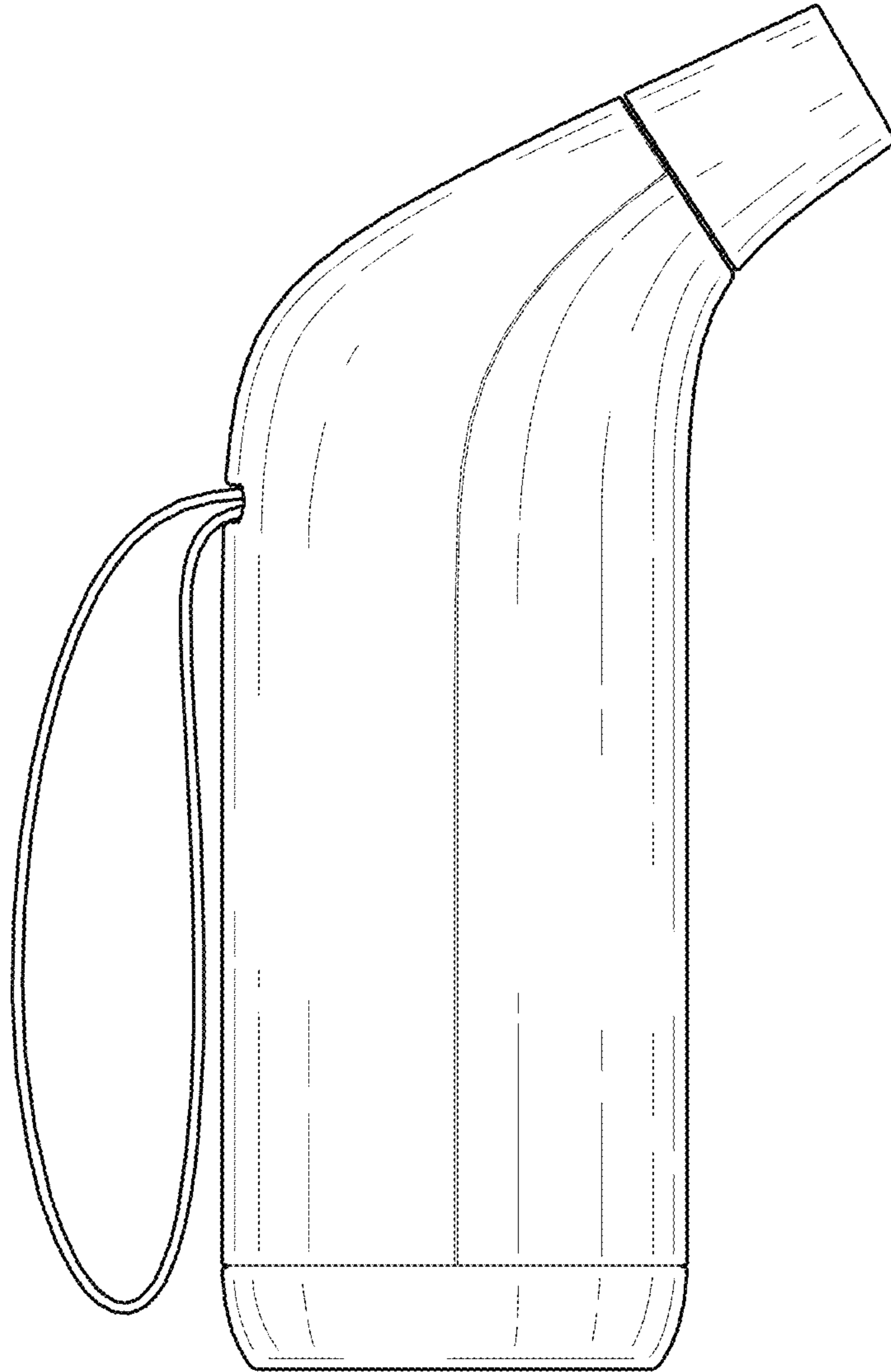

1.4

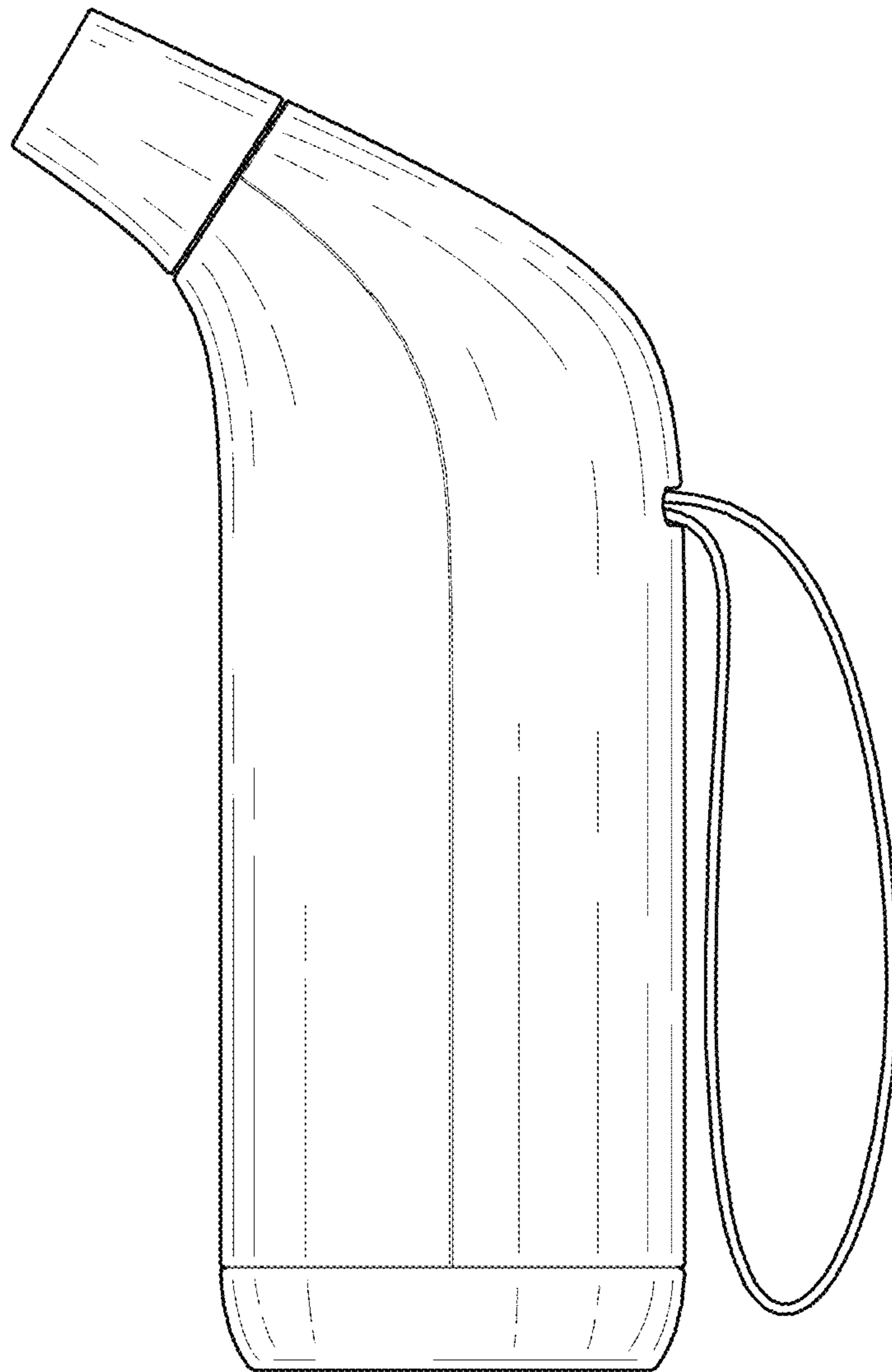

1.5

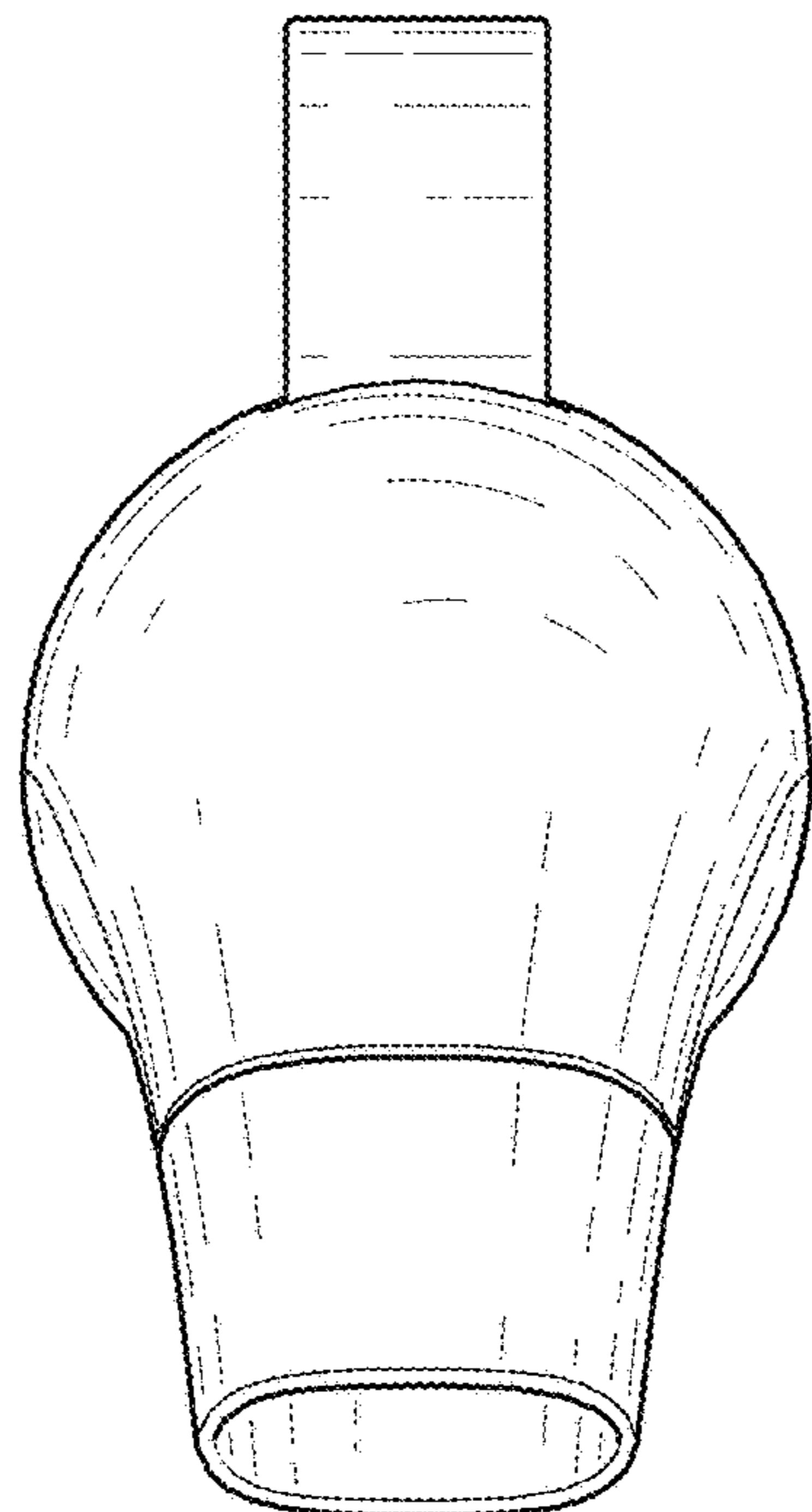

1.6

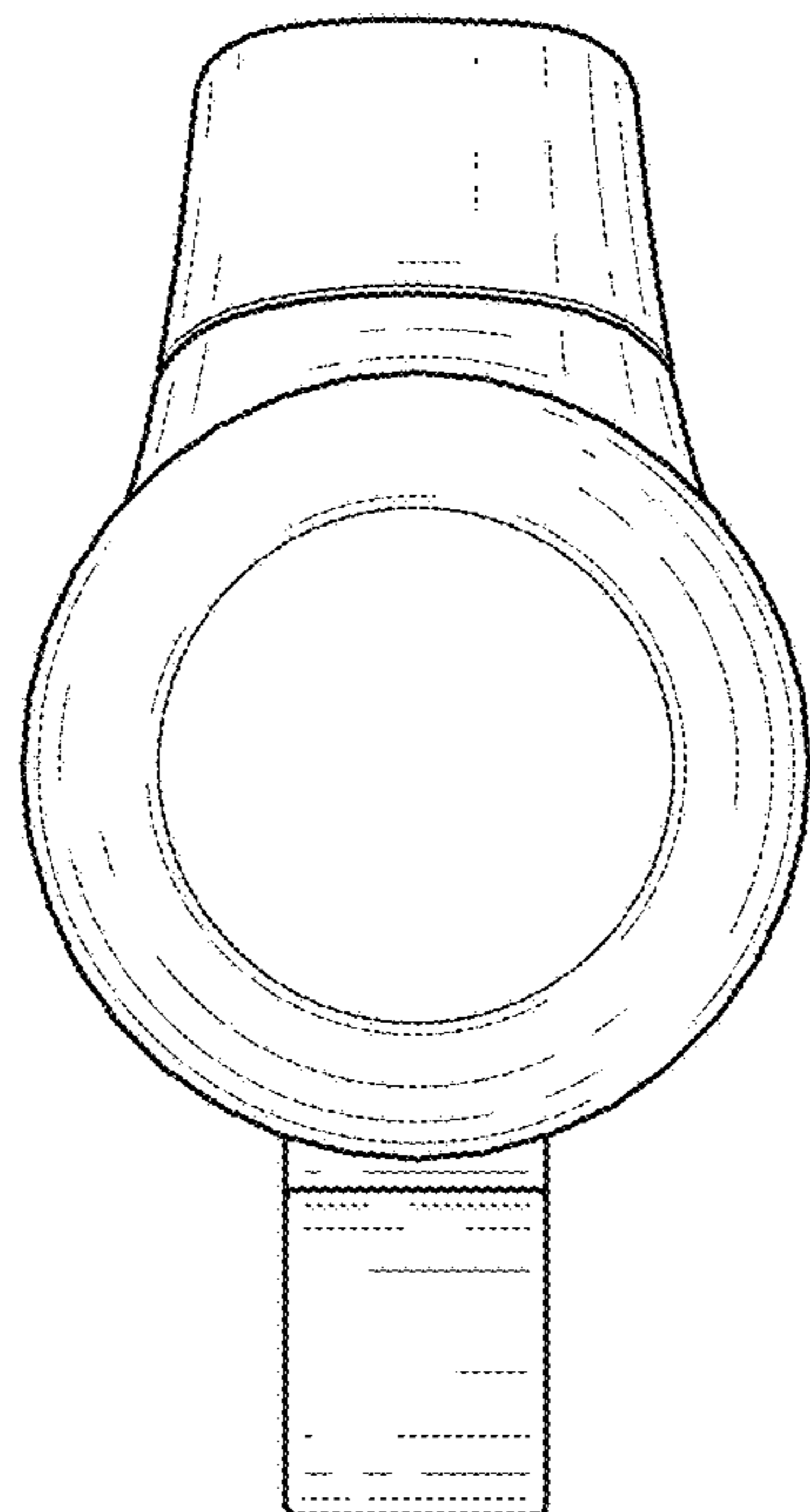

1.7