



US00D825731S

(12) **United States Design Patent** (10) **Patent No.:** **US D825,731 S**  
**Hou** (45) **Date of Patent:** **\*\* Aug. 14, 2018**

(54) **AROMA HUMIDIFIER**

(71) Applicant: **Neng Hou**, Shenzhen (CN)

(72) Inventor: **Neng Hou**, Shenzhen (CN)

(\*\*) Term: **15 Years**

(21) Appl. No.: **29/605,756**

(22) Filed: **May 30, 2017**

(51) **LOC (11) Cl.** ..... **23-04**

(52) **U.S. Cl.**  
USPC ..... **D23/366**

(58) **Field of Classification Search**  
USPC ..... D23/314, 325, 333-336, 355-367,  
D23/386-388

CPC . A61L 9/03; A61L 9/012; A61L 9/015; A61L  
9/037

See application file for complete search history.

(56) **References Cited**

**U.S. PATENT DOCUMENTS**

D611,588 S *	3/2010	Jorgensen	.....	D23/366
D621,495 S *	8/2010	Li	.....	D23/366
D696,763 S *	12/2013	Li	.....	D23/366
D743,527 S *	11/2015	Wang	.....	D23/411
D753,279 S *	4/2016	Li	.....	D23/366
D810,261 S *	2/2018	Chen	.....	D23/366

**OTHER PUBLICATIONS**

Electric Aroma Essential Oil Diffuser found online [Feb. 23, 2018]—<http://www.edaroma.com/electric-essential-oil-aroma-dif-fuser/wood-grain-electric-aroma-essential-oil.html>.\*

\* cited by examiner

*Primary Examiner* — Brandon M Rosati

*Assistant Examiner* — John A Voytek

(74) *Attorney, Agent, or Firm* — Novoclaims Patent Services LLC; Mei Lin Wong

(57) **CLAIM**

The ornamental design for an aroma humidifier, as shown and described.

**DESCRIPTION**

FIG. 1 is a perspective view of an aroma humidifier, showing my new design.

FIG. 2 is a second perspective view thereof.

FIG. 3 is a front elevational view thereof.

FIG. 4 is a rear elevational view thereof.

FIG. 5 is a left side elevational view thereof.

FIG. 6 is a right side elevational view thereof.

FIG. 7 is a top plan view thereof; and,

FIG. 8 is a bottom plan view thereof.

The broken lines in the drawings represent unclaimed subject matter and form no part of the claim.

**1 Claim, 8 Drawing Sheets**

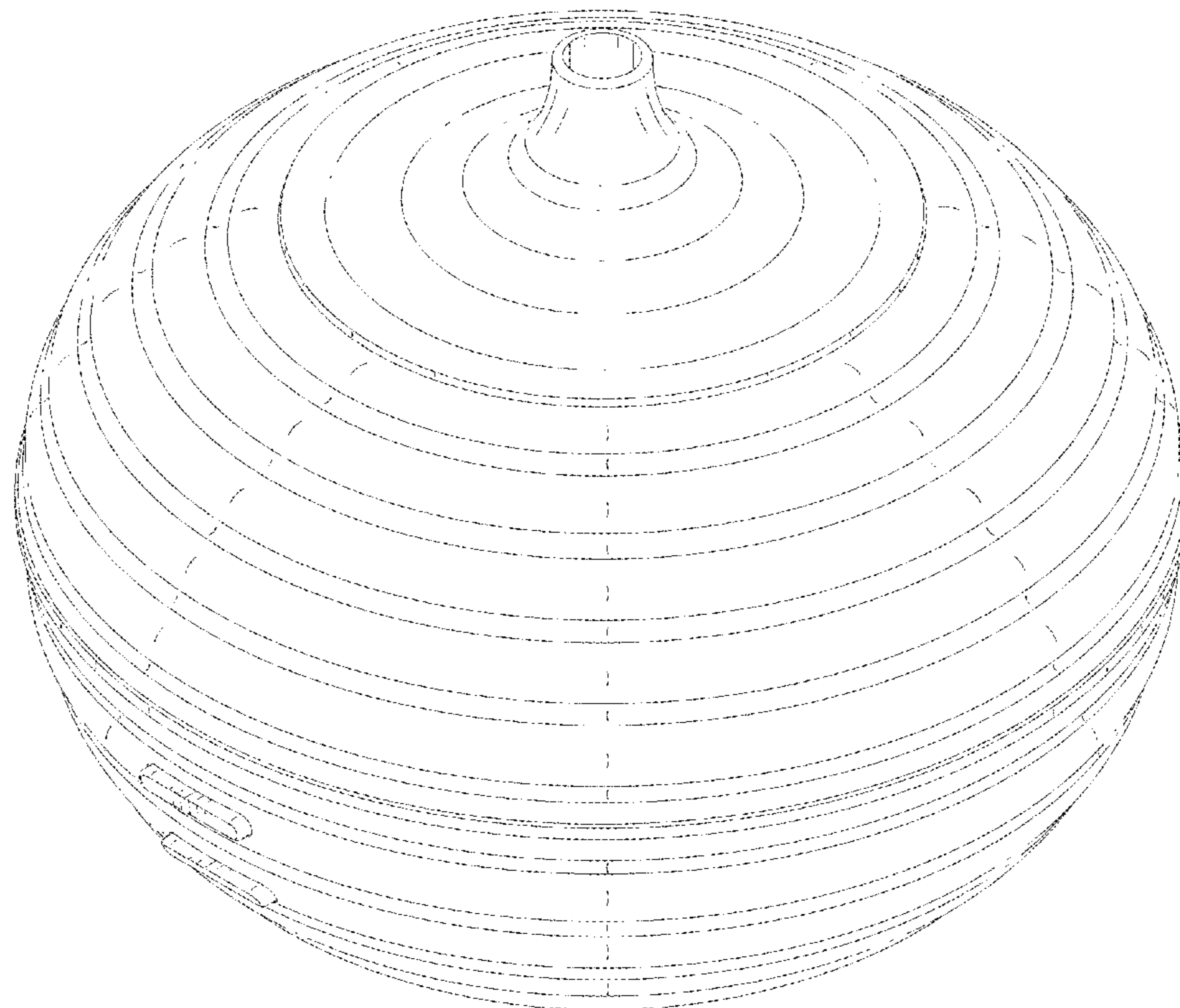

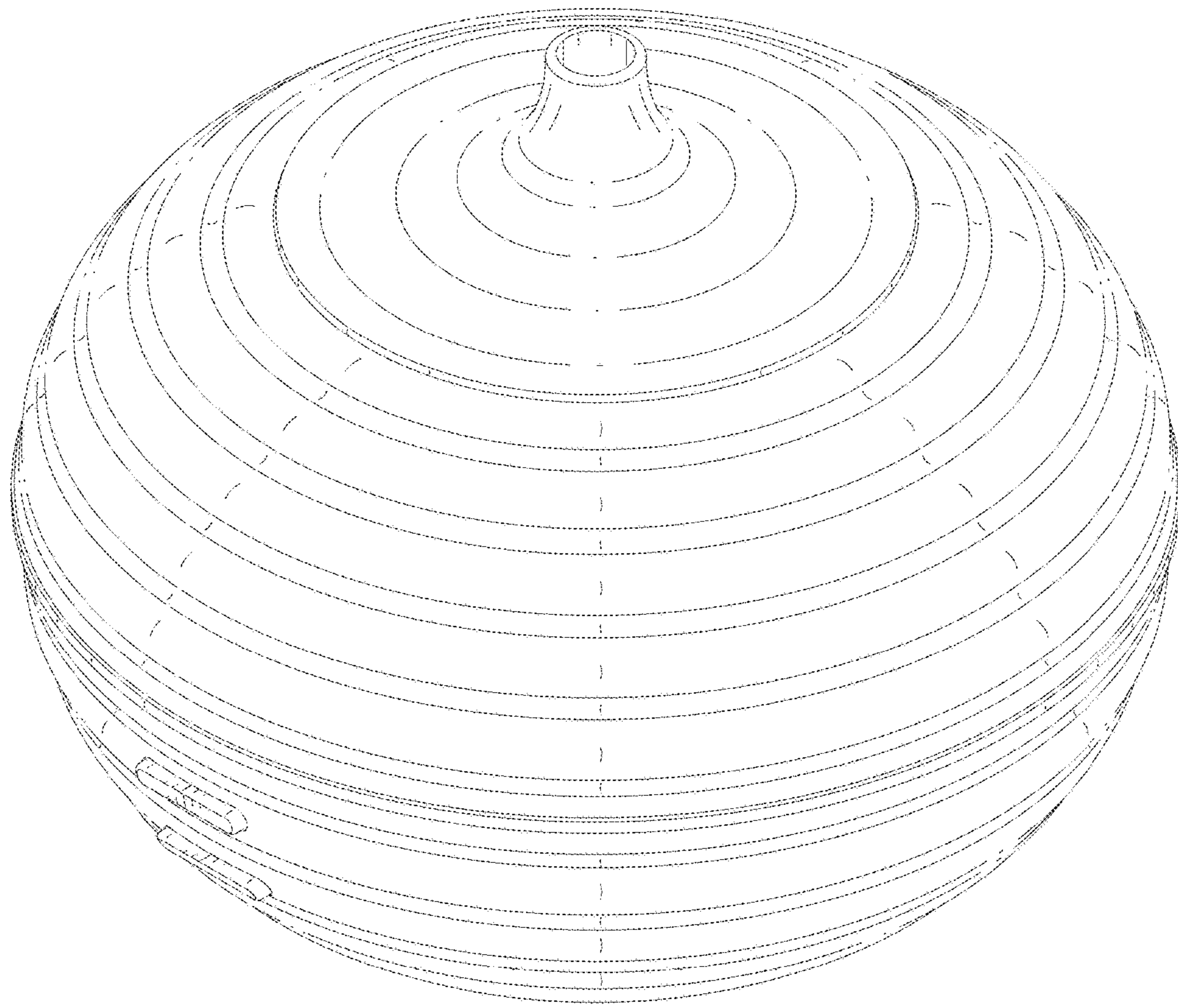

FIG.1

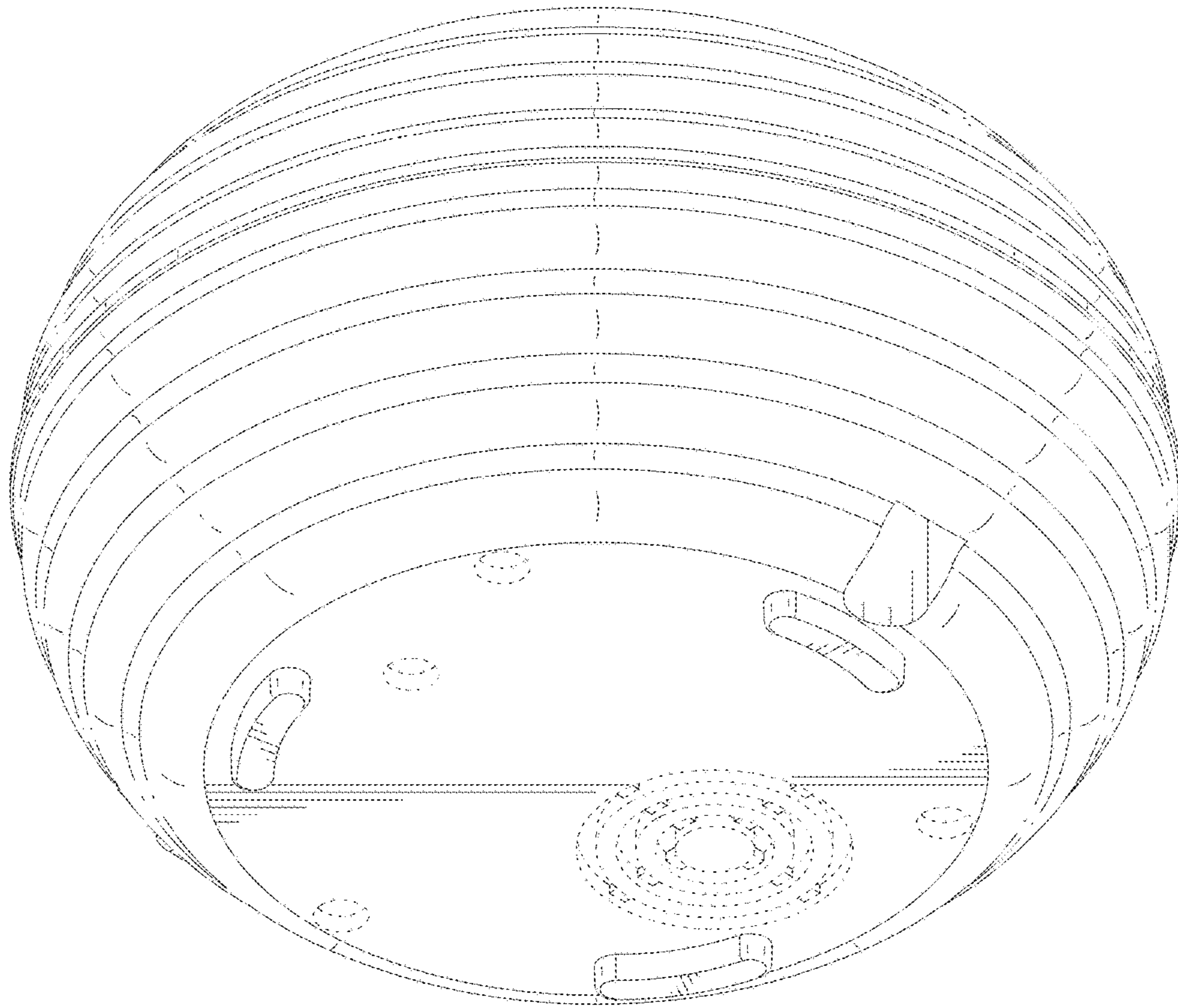

FIG.2

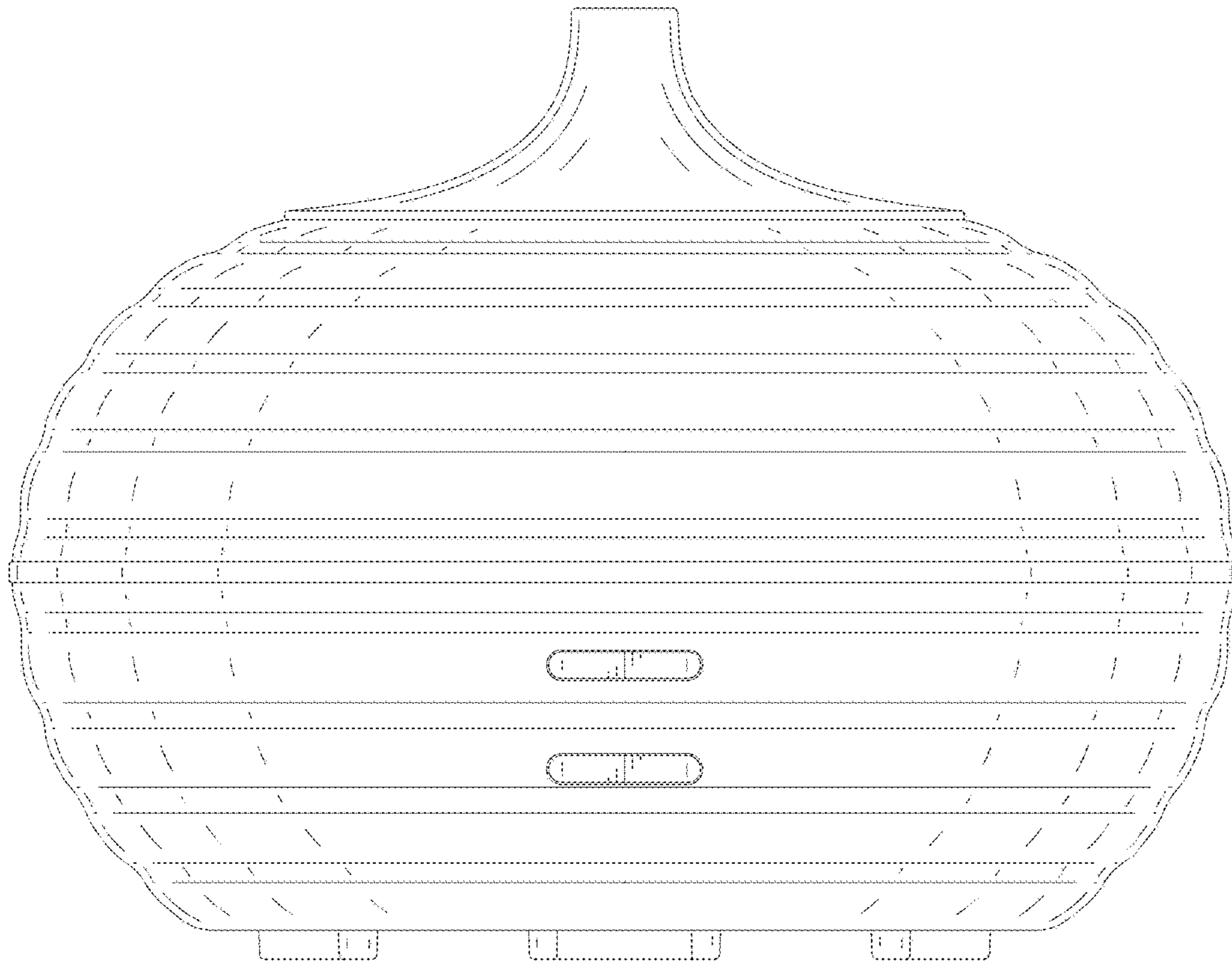

FIG.3



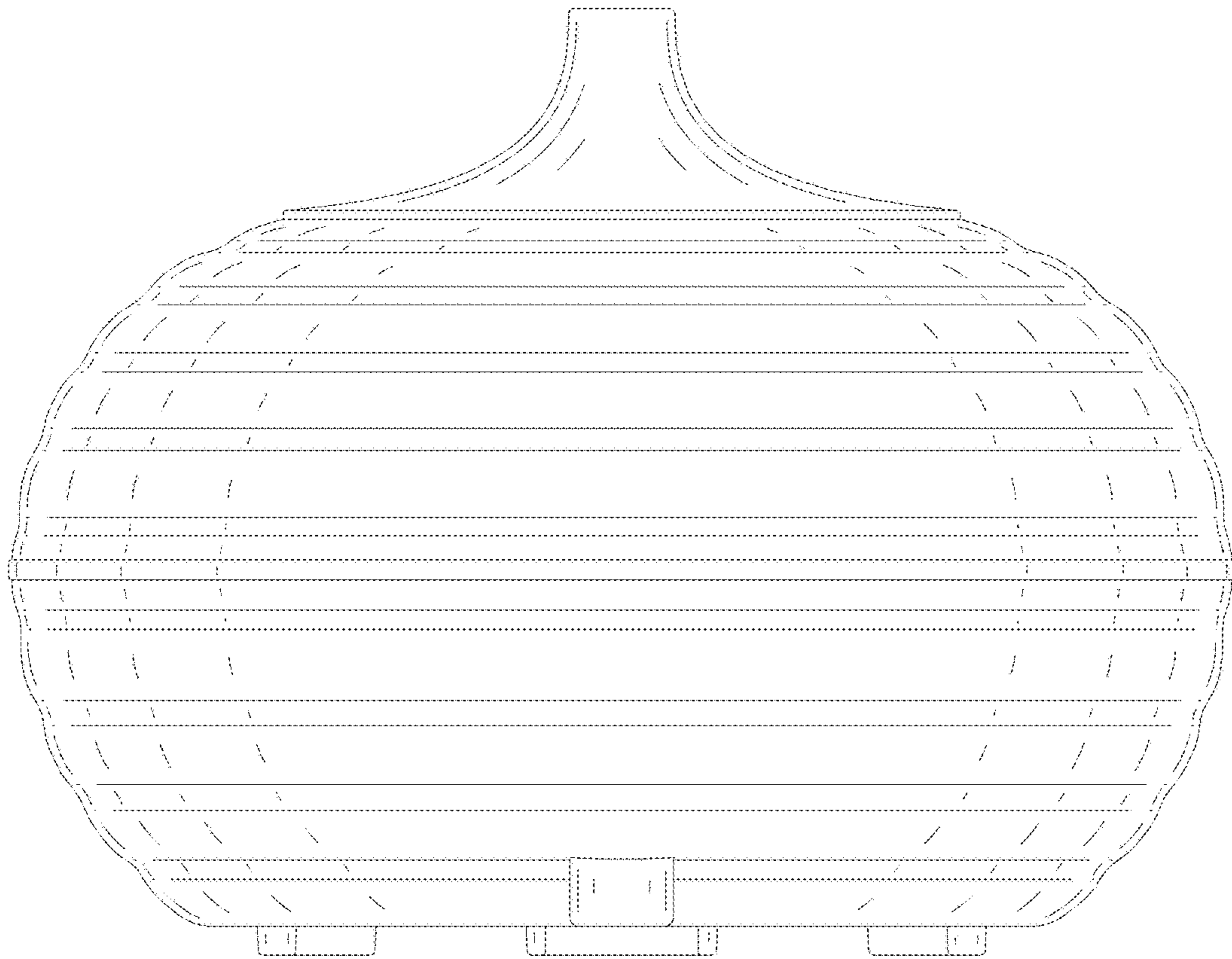

FIG.4

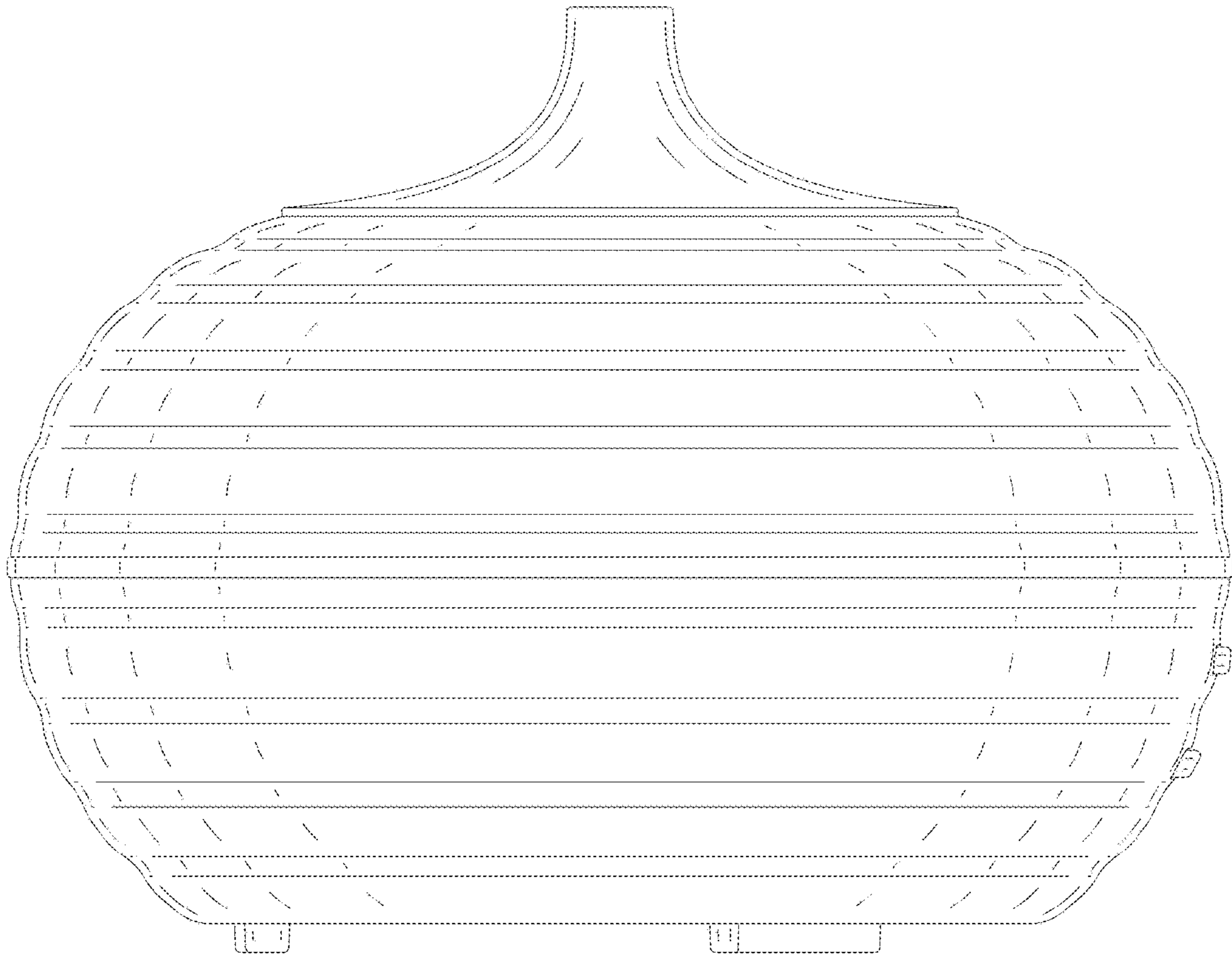

FIG. 5

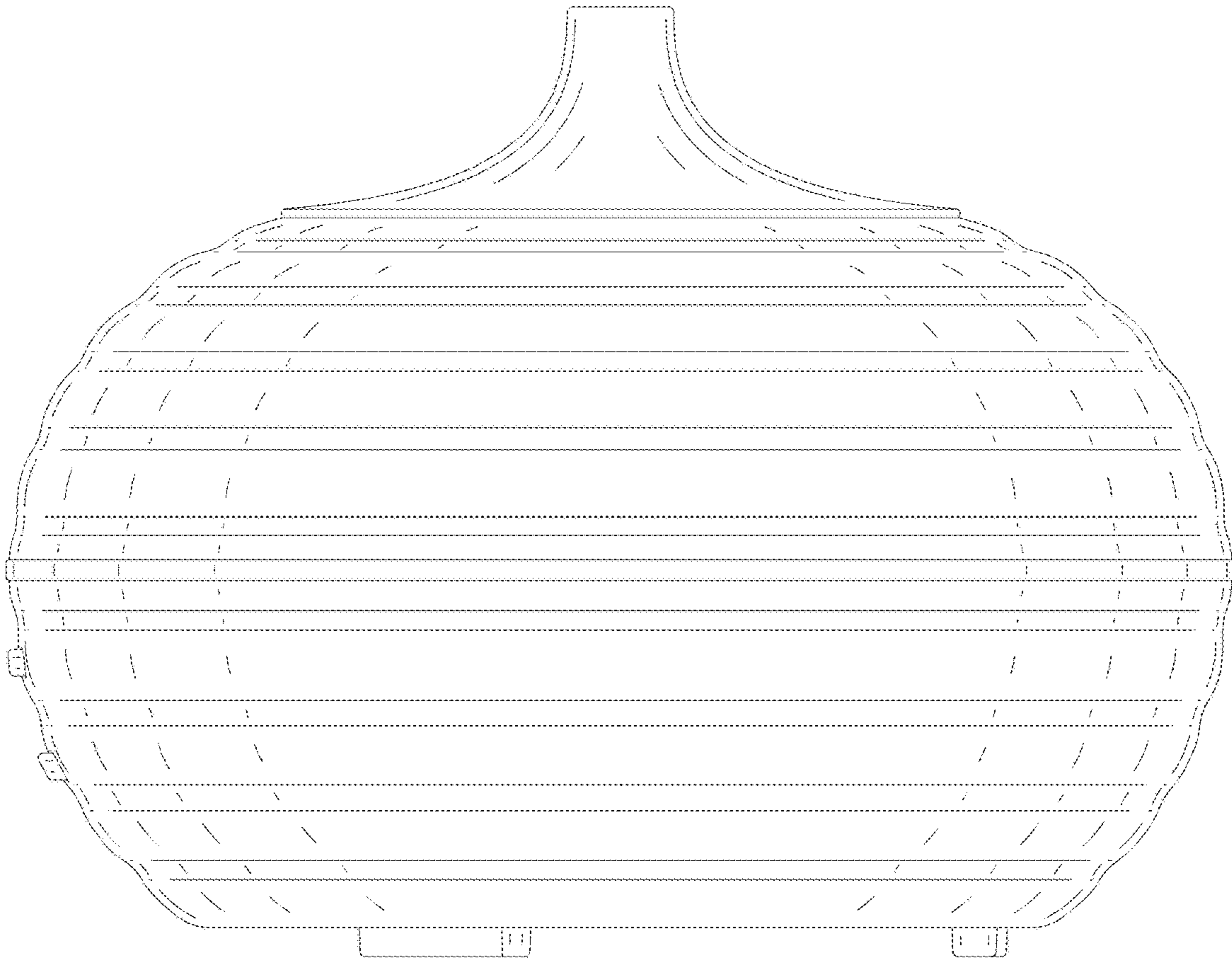

FIG.6

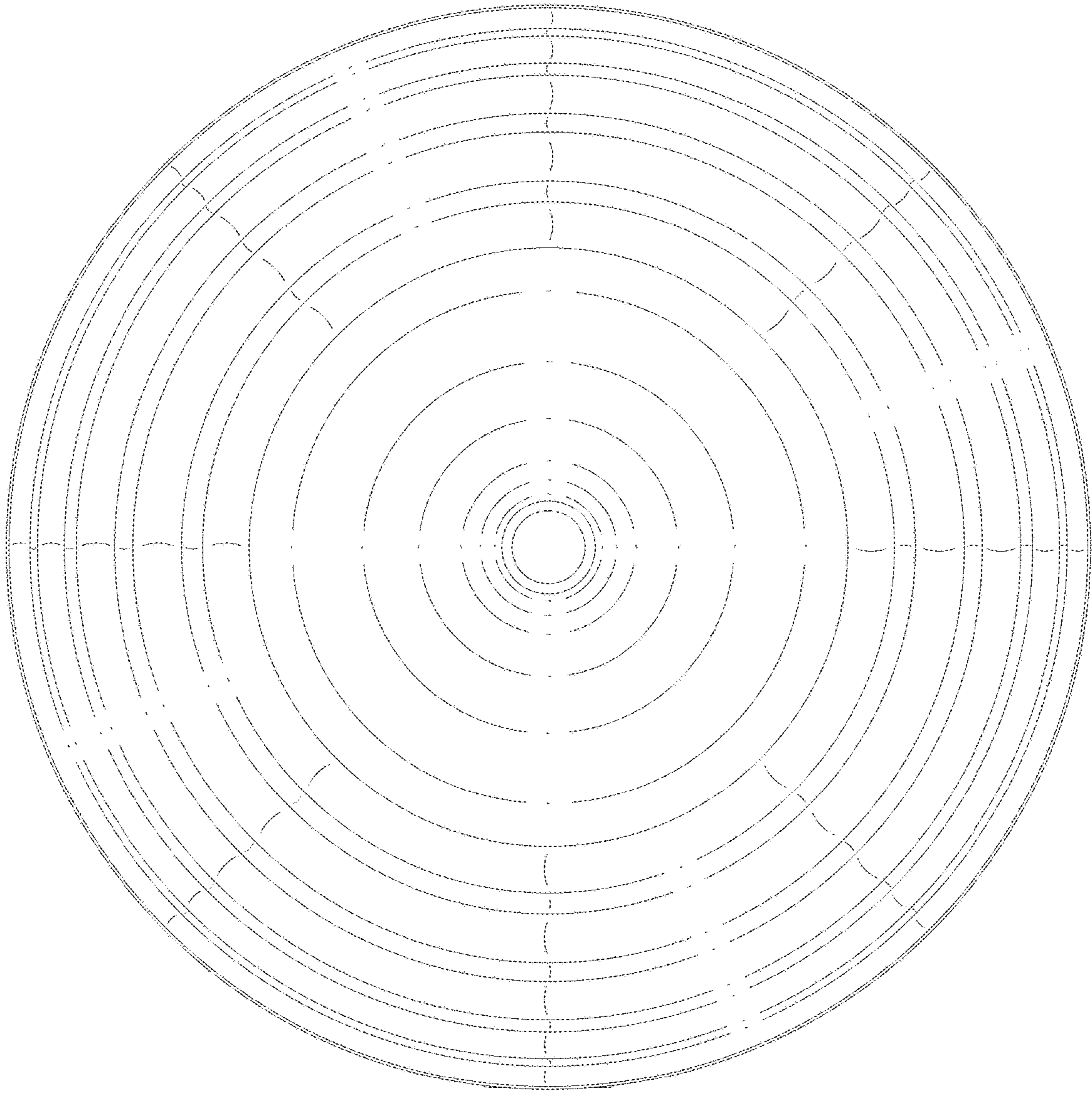

FIG. 7



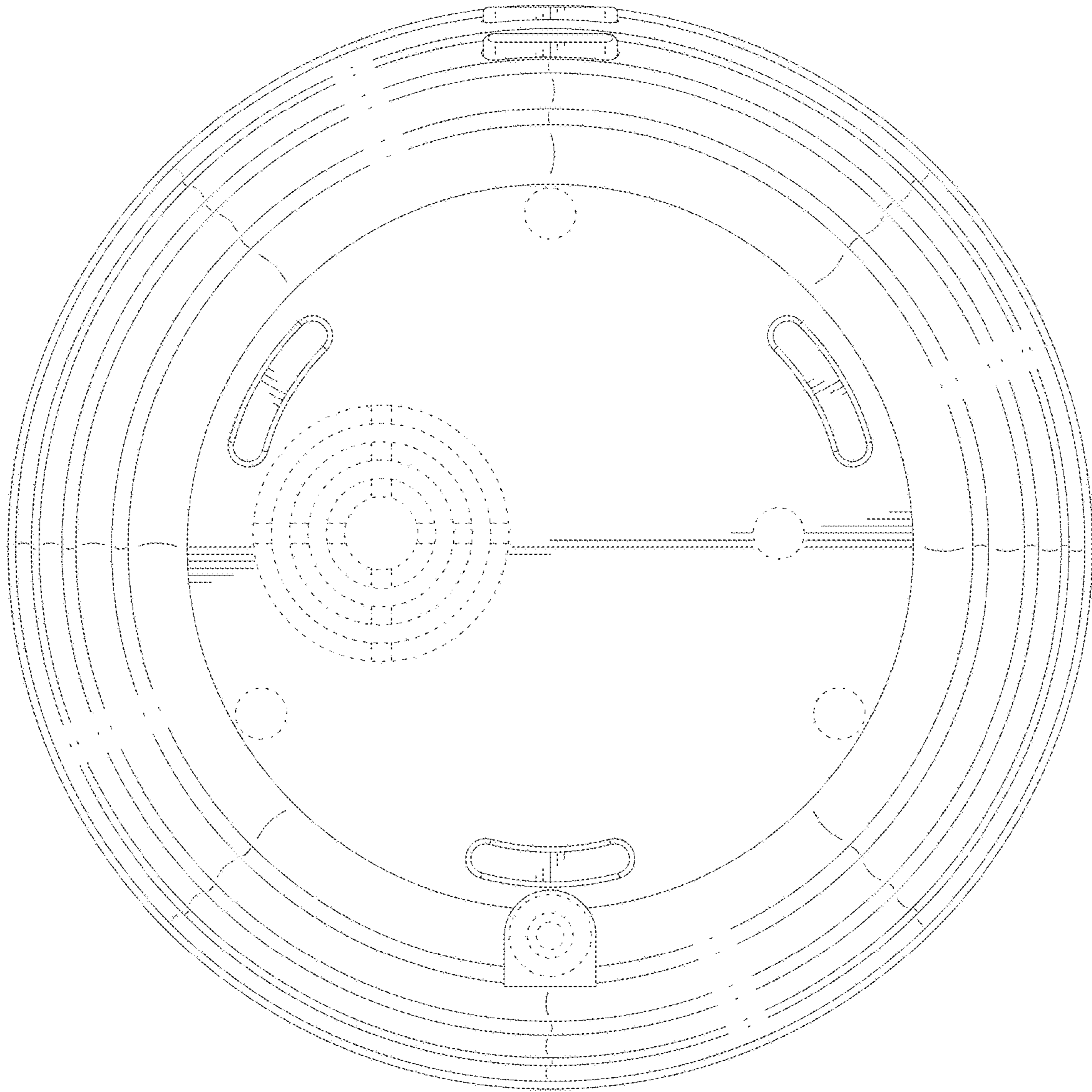

FIG.8