



US00D825577S

(12) **United States Design Patent** (10) **Patent No.:** **US D825,577 S**
Brander et al. (45) **Date of Patent:** **** Aug. 14, 2018**

- (54) **WALL MOUNTED READER**
- (71) Applicant: **QIBLXX AG**, Buchs (CH)
- (72) Inventors: **Dragan Brander**, St. Gallen (CH);
Stefan Baumann, Zürich (CH)
- (73) Assignee: **Qibixx AG**, Buchs (CH)
- (**) Term: **15 Years**
- (21) Appl. No.: **35/501,946**
- (22) Filed: **May 20, 2016**

- (80) **Hague Agreement Data**
 Int. Filing Date: **May 20, 2016**
 Int. Reg. No.: **DM/091793**
 Int. Reg. Date: **May 20, 2016**
 Int. Reg. Pub. Date: **Nov. 25, 2016**
- (51) **LOC (11) Cl.** **14-99**
- (52) **U.S. Cl.**
 USPC **D14/474**
- (58) **Field of Classification Search**
 USPC D14/356-358, 383-385, 420, 426, 427,
 D14/432-439, 447, 453, 454, 217, 253,
 D14/299, 307; D13/107, 108, 133, 146,
 D13/147, 152, 154, 156, 158, 162, 162.1,
 D13/168, 173, 177, 102
 CPC G07F 7/0886; G06Q 30/06; G06Q 40/02;
 G06Q 20/347; G06Q 20/322
 See application file for complete search history.

- (56) **References Cited**
 U.S. PATENT DOCUMENTS
 D234,699 S * 4/1975 Conway et al. D14/385
 D239,029 S * 3/1976 Conway et al. D14/385
 D241,445 S * 9/1976 Pycha D14/385
 D303,376 S * 9/1989 Nishida D14/385
 D538,806 S * 3/2007 Brod D14/385

- D711,875 S * 8/2014 Daniel D14/385
- D711,876 S * 8/2014 McWilliam D14/385
- D742,878 S * 11/2015 Sedlmeir D14/385
- D797,739 S * 9/2017 Templeton D14/385
- 2003/0168949 A1* 9/2003 Hales H05K 7/186
 312/223.1

* cited by examiner

Primary Examiner — Michael A. Pratt

(74) *Attorney, Agent, or Firm* — Sughrue Mion, PLLC

(57) **CLAIM**

The ornamental design for a wall mounted reader, as shown and described.

DESCRIPTION

The patent or application file contains at least one drawing executed in color. Copies of this patent or patent application publication with color drawing(s) will be provided by the Office upon request and payment of the necessary fee.

- 1.-2. Wall mounted reader
- 1.1 is a Front View
- 1.2 is a Back View
- 1.3 is a Left View
- 1.4 is a Right View
- 1.5 is a Top View
- 1.6 is a Bottom View
- 1.7 is a Perspective View
- 1.8 is a Perspective View
- 1.9 is a Perspective View
- 2.1 is a Front View
- 2.2 is a Back View
- 2.3 is a Left View
- 2.4 is a Right View
- 2.5 is a Top View
- 2.6 is a Bottom View
- 2.7 is a Perspective View
- 2.8 is a Perspective View

1 Claim, 17 Drawing Sheets
(9 of 17 Drawing Sheet(s) Filed in Color)

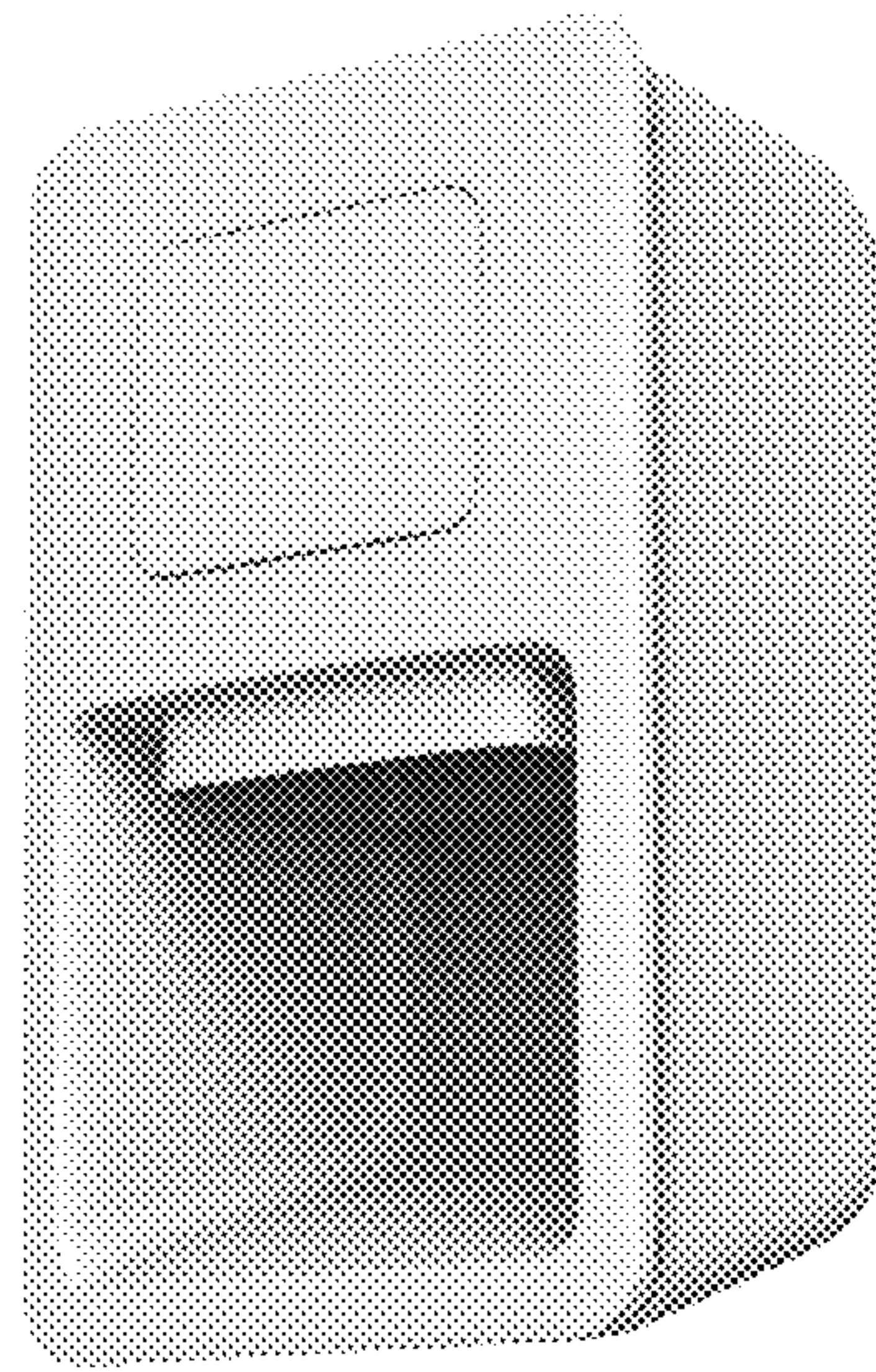
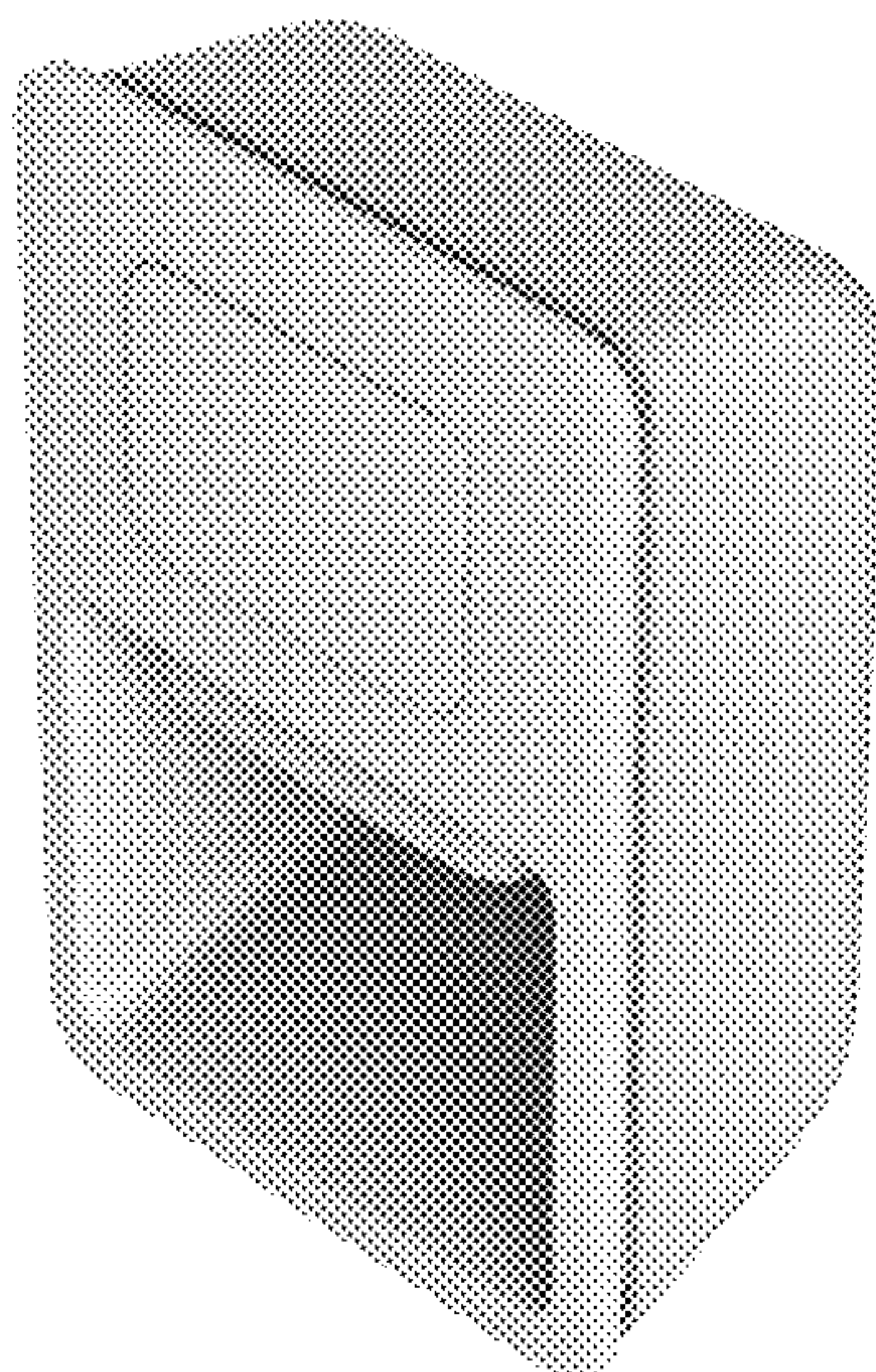

1.1



1.2

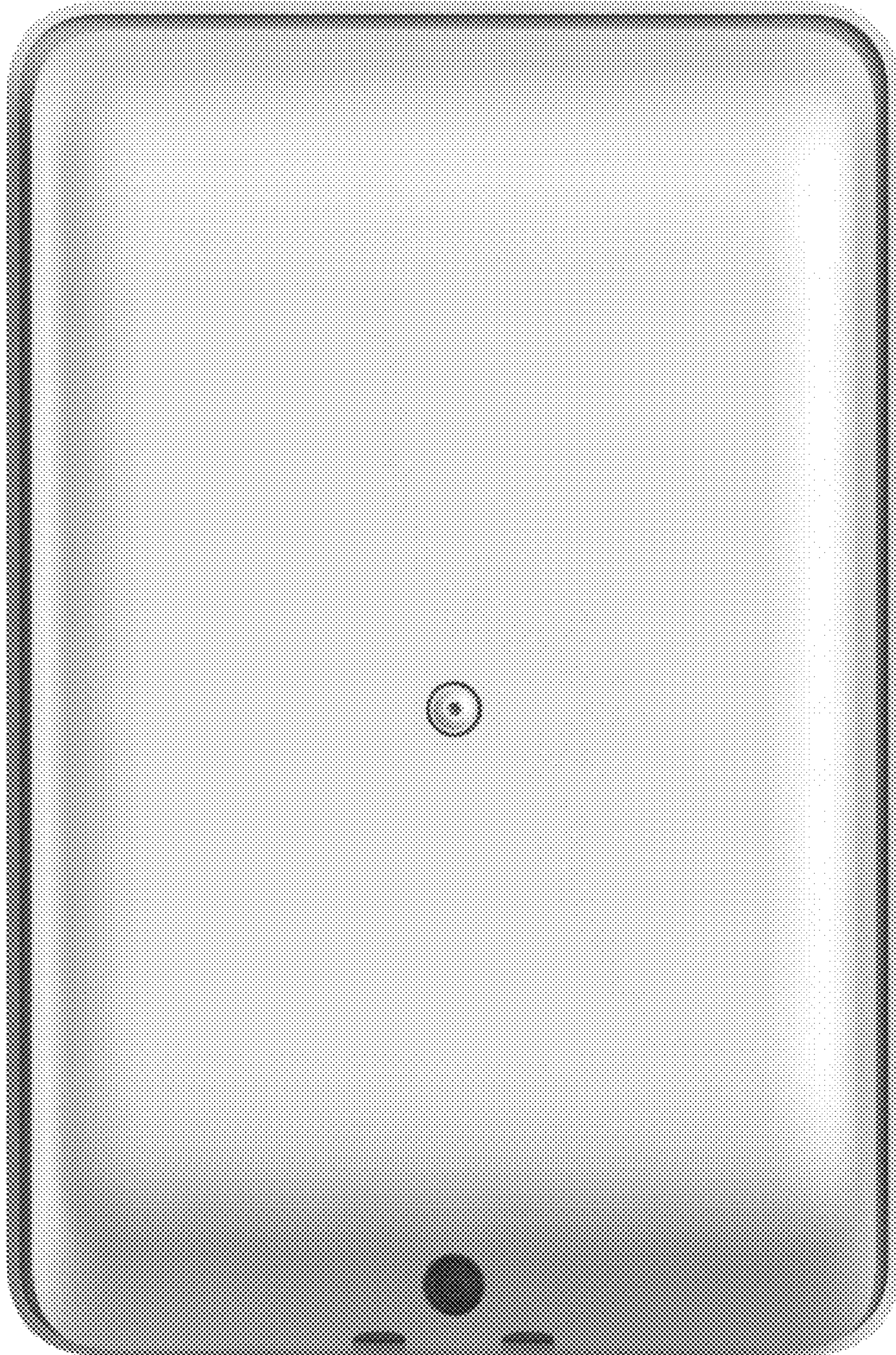

1.3



1.4

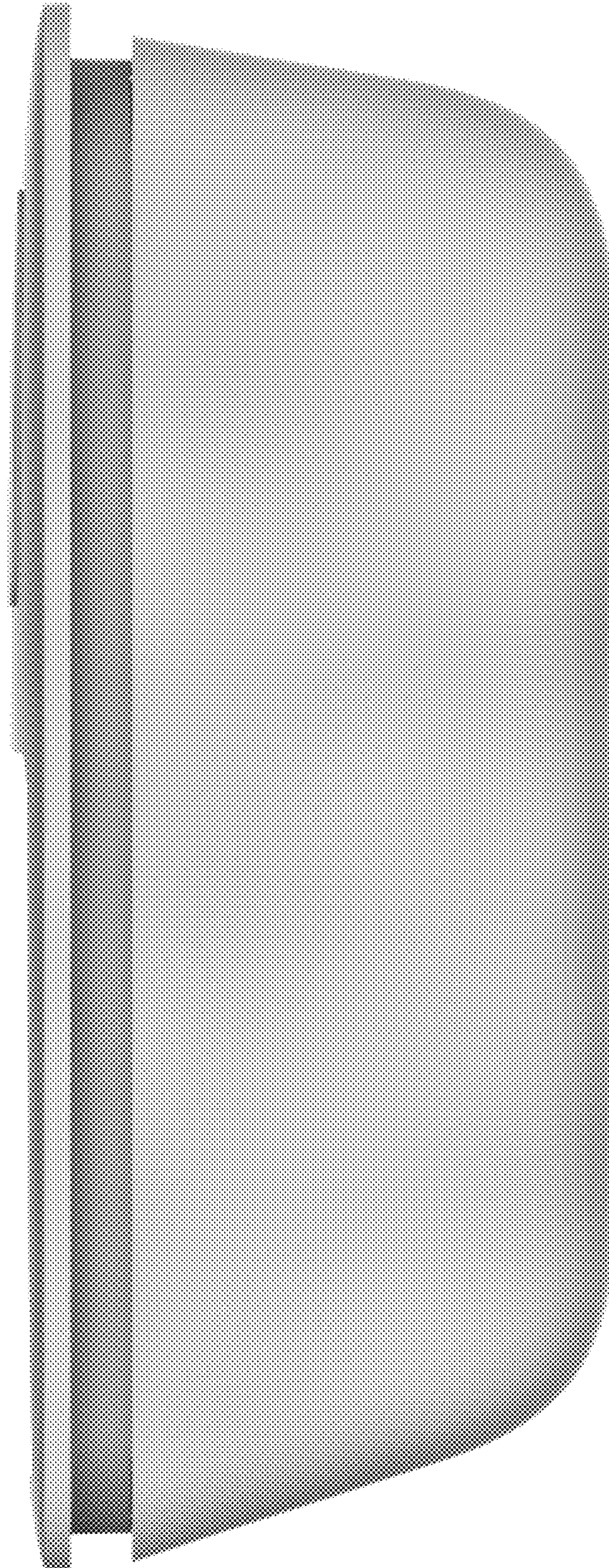

1.5



1.6

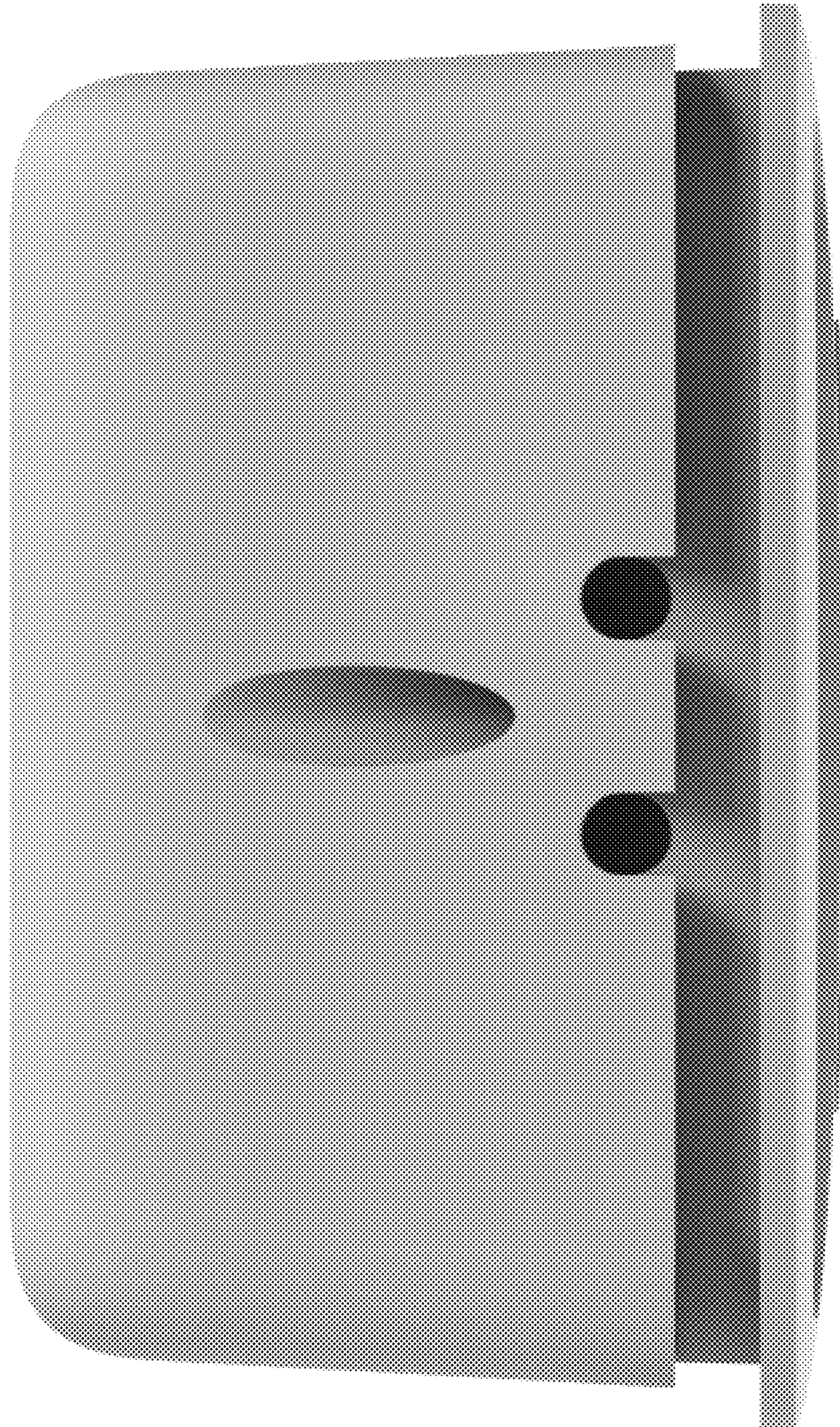

1.7



1.8



1.9

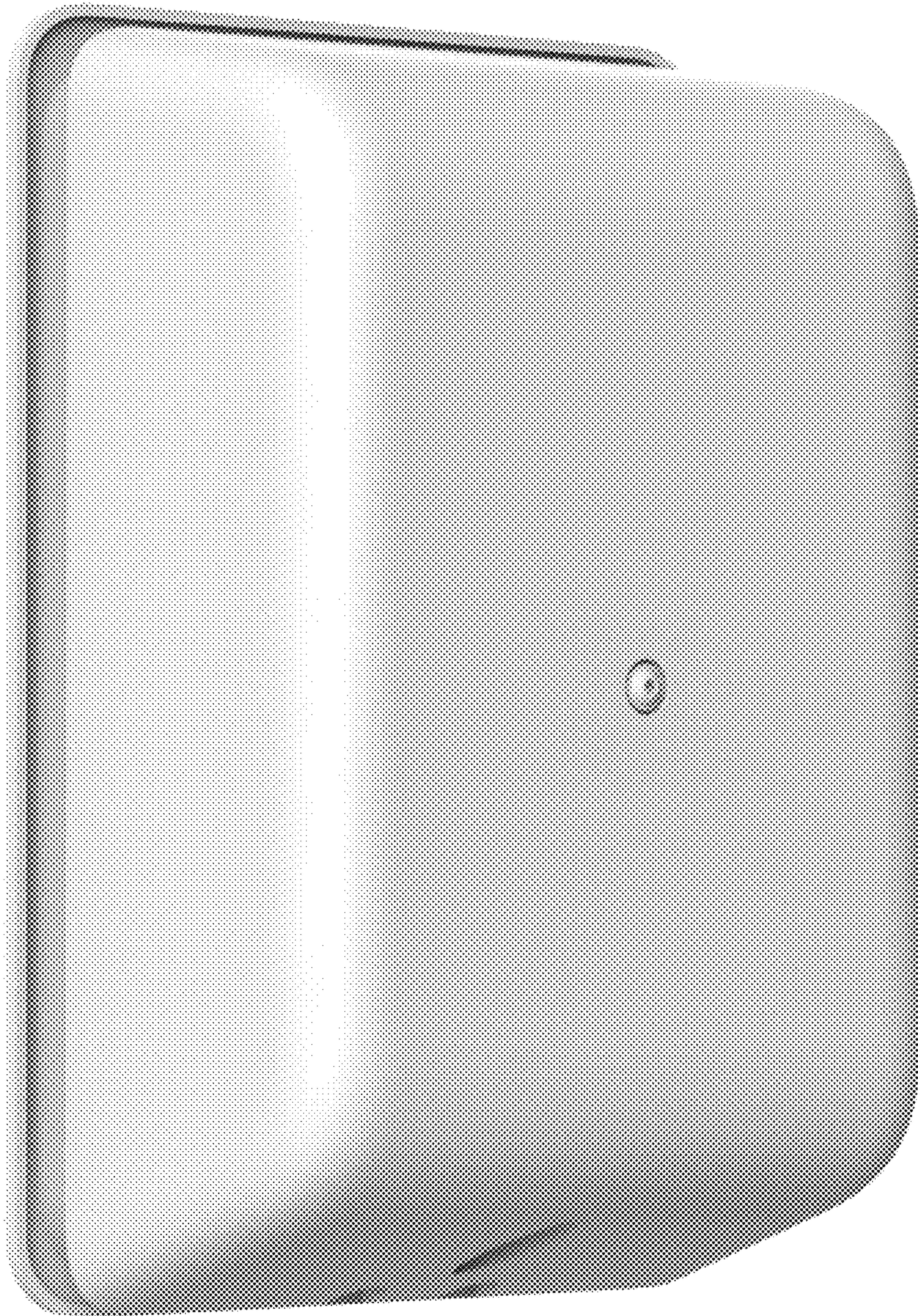

2.1

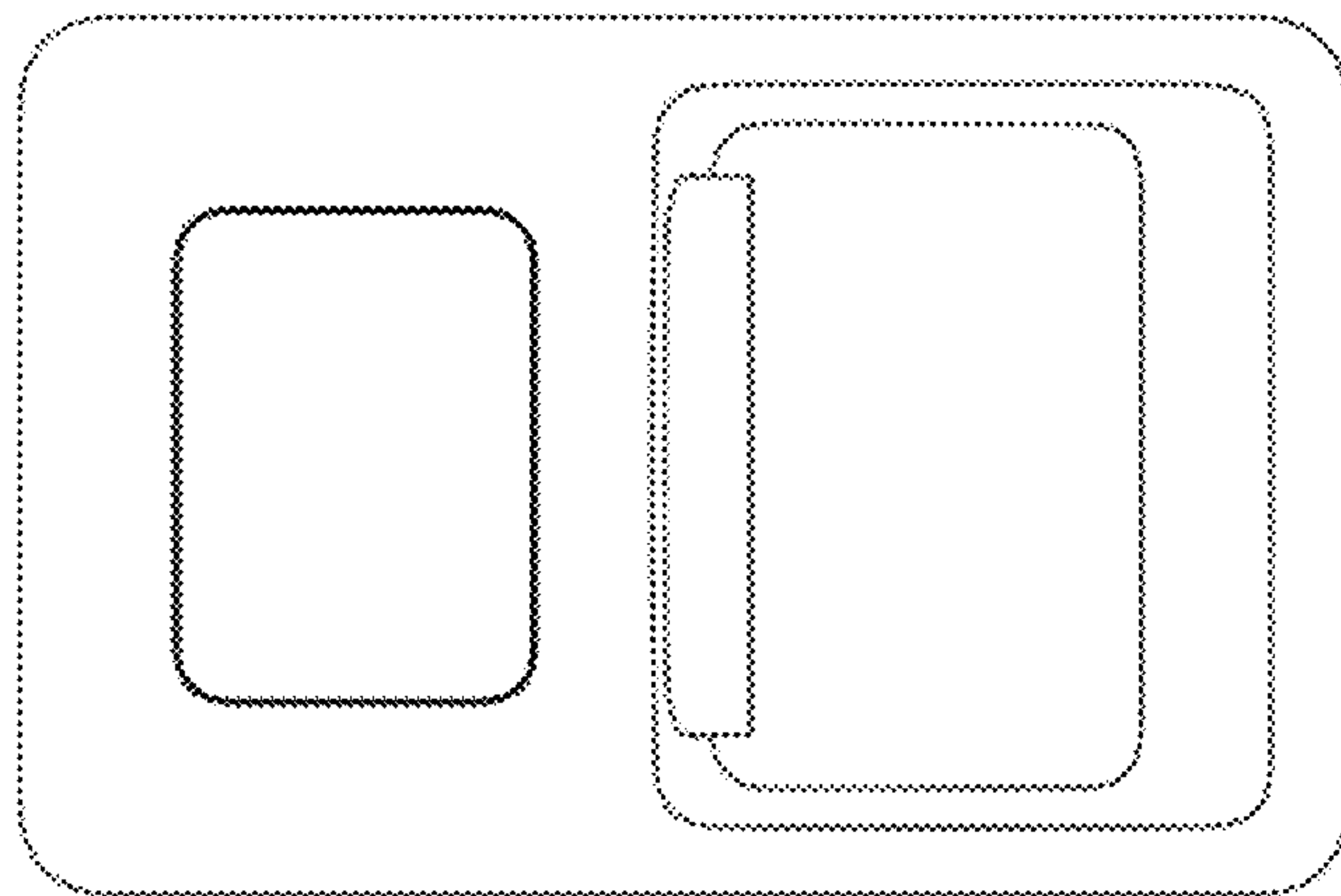

2.2



2.3

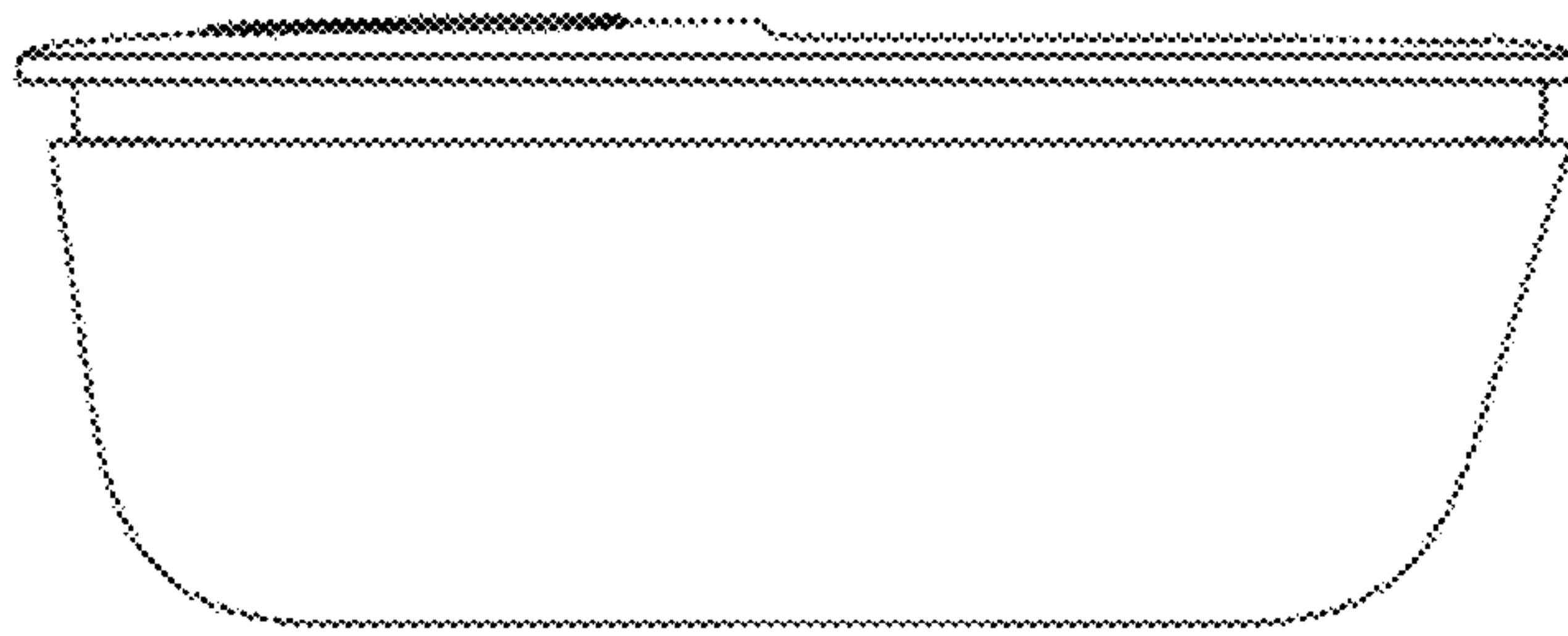

2.4

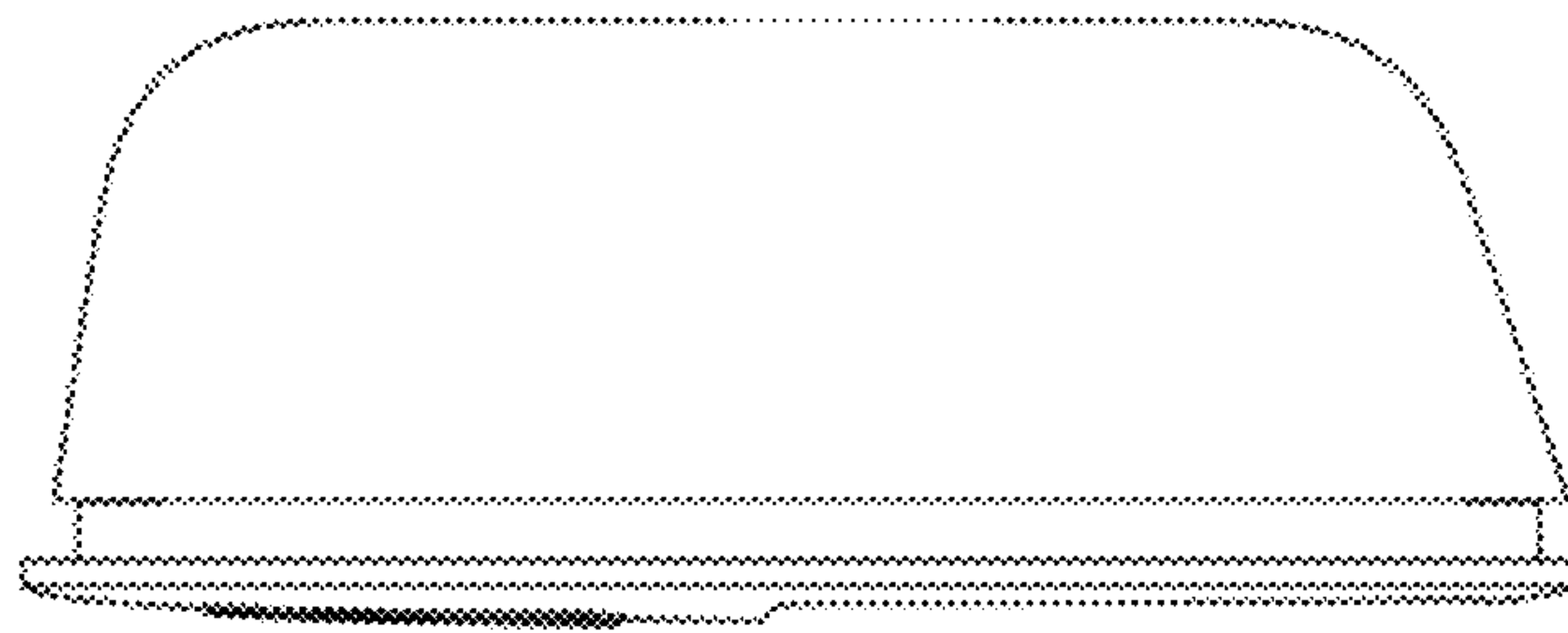

2.5

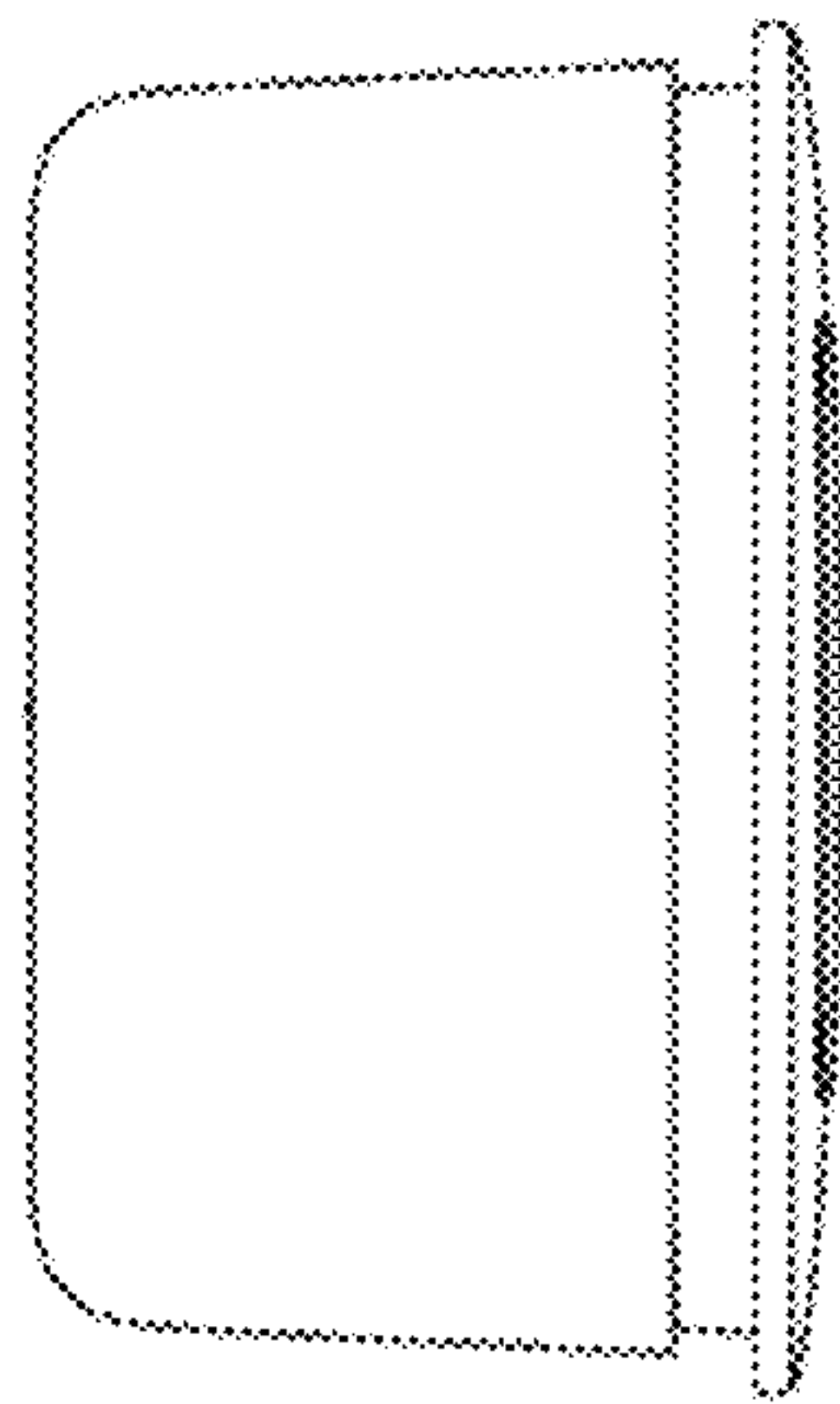

2.6

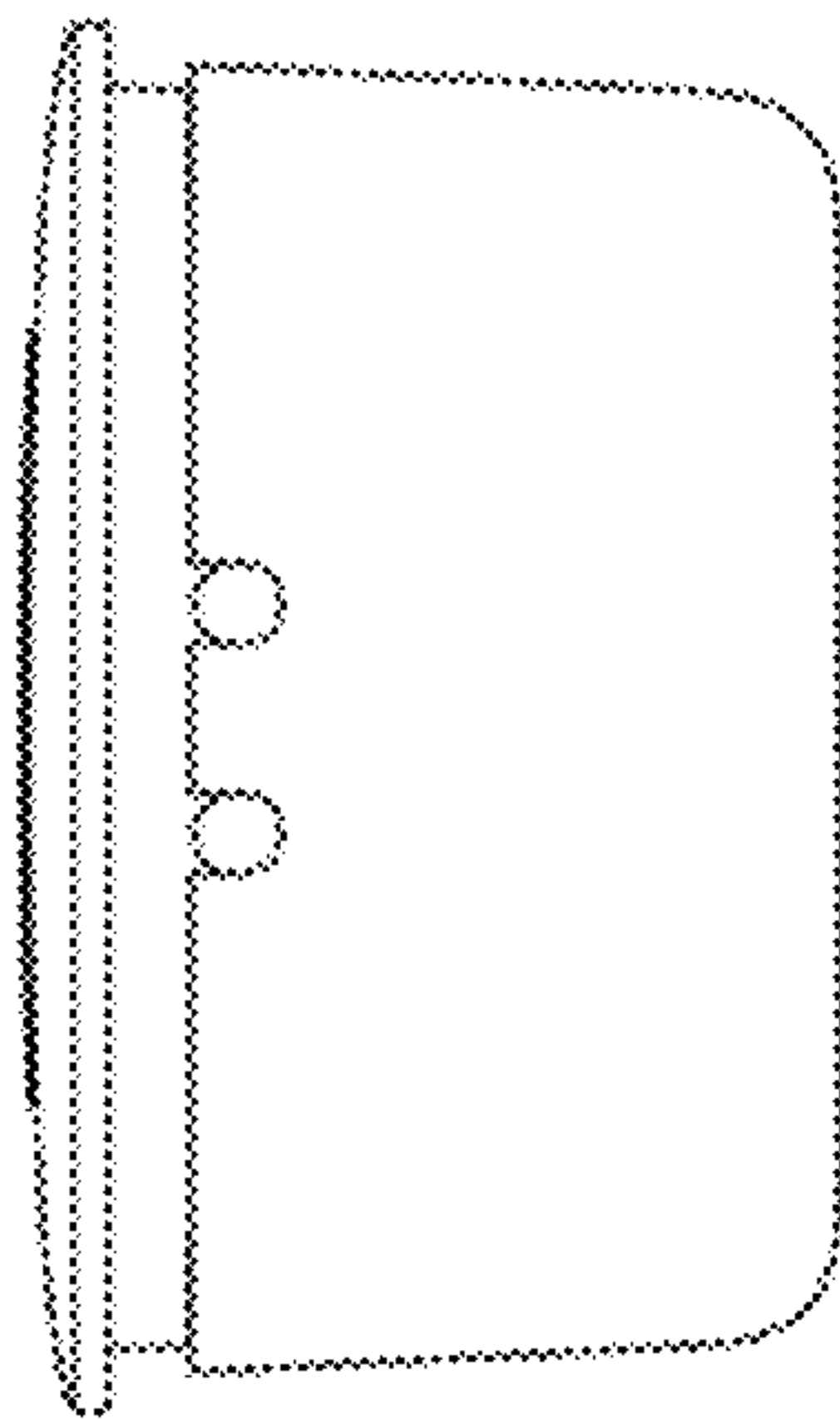

2.7

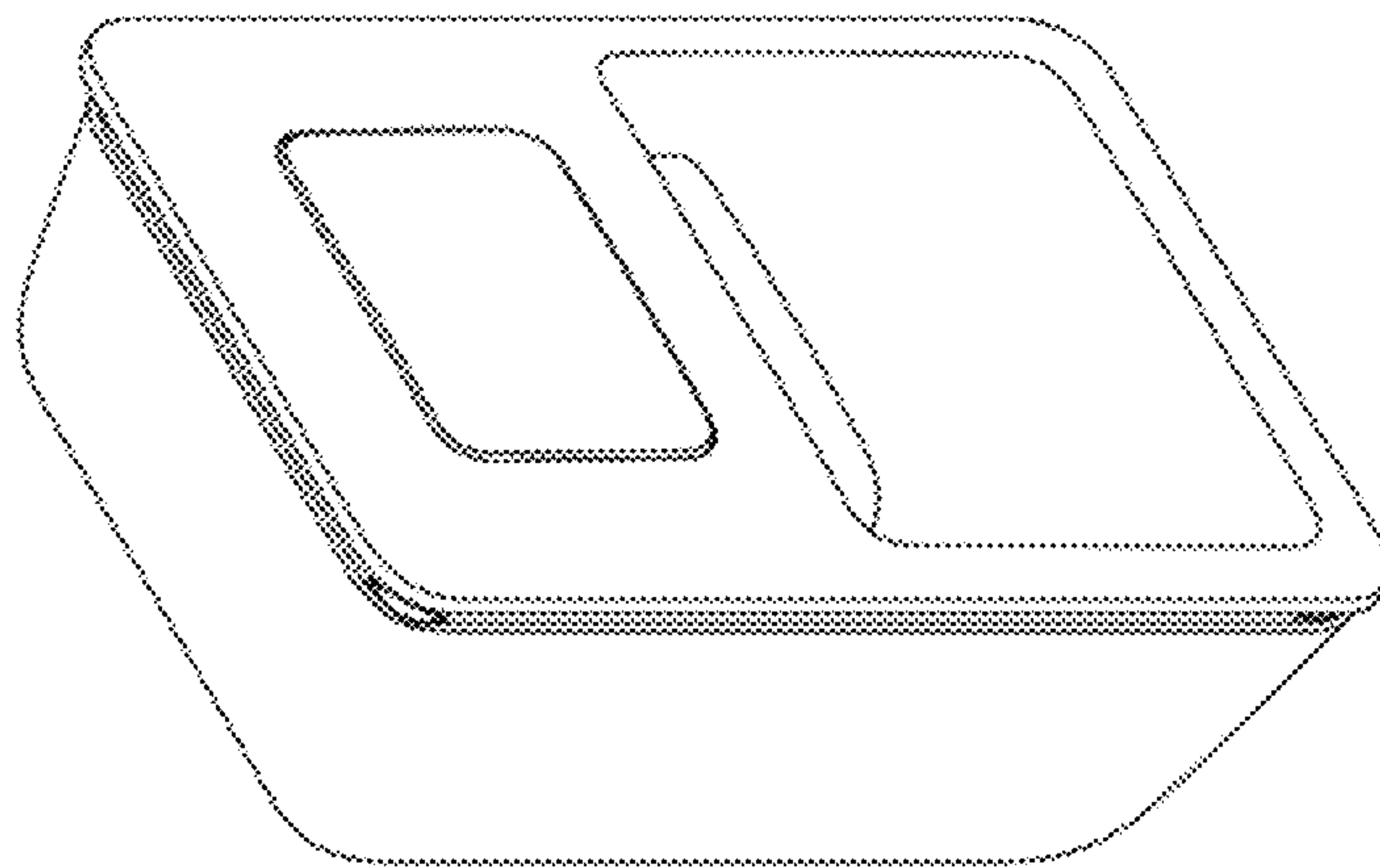

2.8

