



US00D825546S

(12) **United States Design Patent**
Fan

(10) **Patent No.:** **US D825,546 S**

(45) **Date of Patent:** **** Aug. 14, 2018**

(54) **SUCTION CUP APPARATUS HOLDER**

(71) Applicant: **Eagle Fan**, Chu-Pei (TW)

(72) Inventor: **Eagle Fan**, Chu-Pei (TW)

(**) Term: **15 Years**

(21) Appl. No.: **29/579,797**

(22) Filed: **Oct. 4, 2016**

(51) **LOC (11) Cl.** **14-03**

(52) **U.S. Cl.**
USPC **D14/253**

(58) **Field of Classification Search**
USPC D14/251, 240, 217, 447, 253; 224/558
CPC H04B 1/3888; H04M 1/0283; A45C 1/06
See application file for complete search history.

(56) **References Cited**

U.S. PATENT DOCUMENTS

D562,331 S *	2/2008	Li	D14/451
D681,028 S *	4/2013	Richter	D14/253
D709,074 S *	7/2014	Tsui	D14/447
8,981,962 B2 *	3/2015	Fu	B60R 11/02 340/439
D799,469 S *	10/2017	Esses	D14/253
D811,856 S *	3/2018	Richter	D8/355
D819,015 S *	5/2018	Lee	D14/253
2009/0050758 A1 *	2/2009	Carnevali	F16B 47/00 248/205.8
2010/0320341 A1 *	12/2010	Baumann	B60R 11/0241 248/206.2

2014/0145051 A1* 5/2014 Gwag B60R 11/02
248/298.1

2014/0176062 A1* 6/2014 Jung B60R 11/02
320/108

2015/0140935 A1* 5/2015 Wong H04M 1/04
455/41.3

* cited by examiner

Primary Examiner — Cynthia R Underwood
(74) *Attorney, Agent, or Firm* — Lin & Associates
Intellectual Property, Inc.

(57) **CLAIM**

The ornamental design for a suction cup apparatus holder, as shown and described.

DESCRIPTION

FIG. 1 is a perspective view of a suction cup apparatus holder showing my new design; FIG. 2 is a front elevational view thereof; FIG. 3 is a rear elevational view thereof; FIG. 4 is a left elevational view thereof; FIG. 5 is a right elevational view thereof; FIG. 6 is a top view thereof; FIG. 7 is a bottom view thereof; and, FIG. 8 and FIG. 9 are perspective views of the suction cup apparatus holder showing states of use thereof. The broken line showing illustrates portions of the suction cup apparatus holder that form no part of the claimed design.

1 Claim, 9 Drawing Sheets

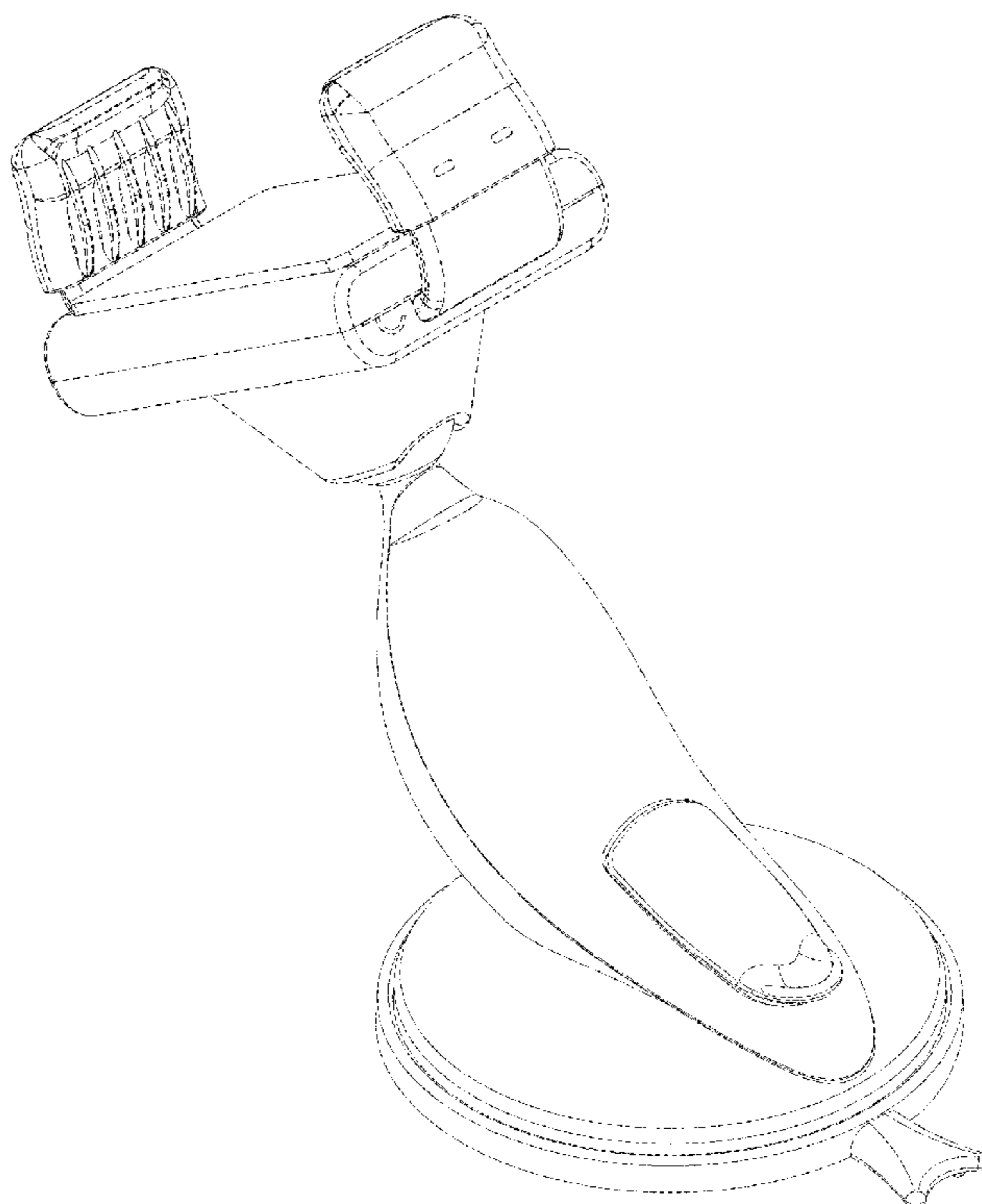

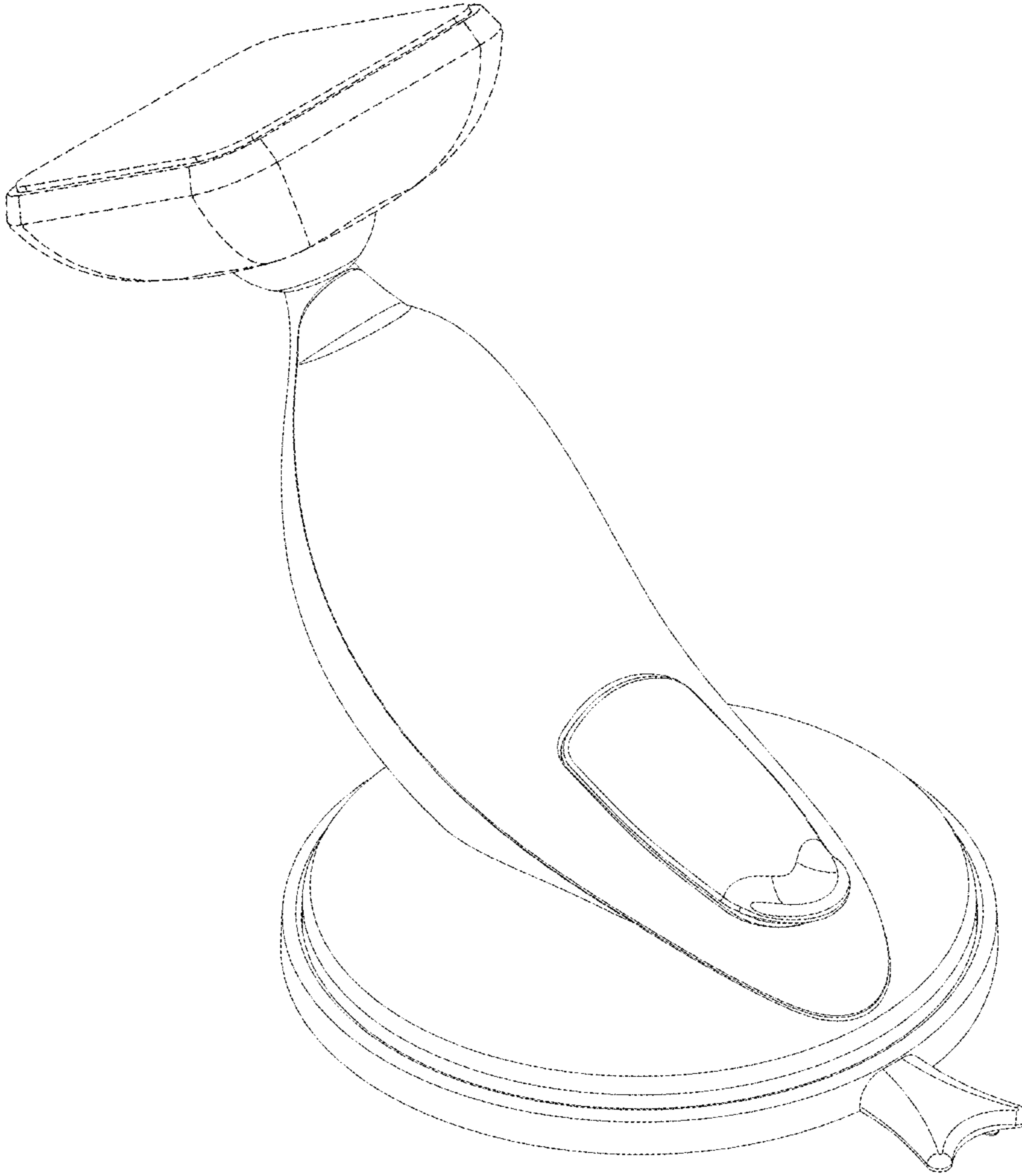

FIG. 1

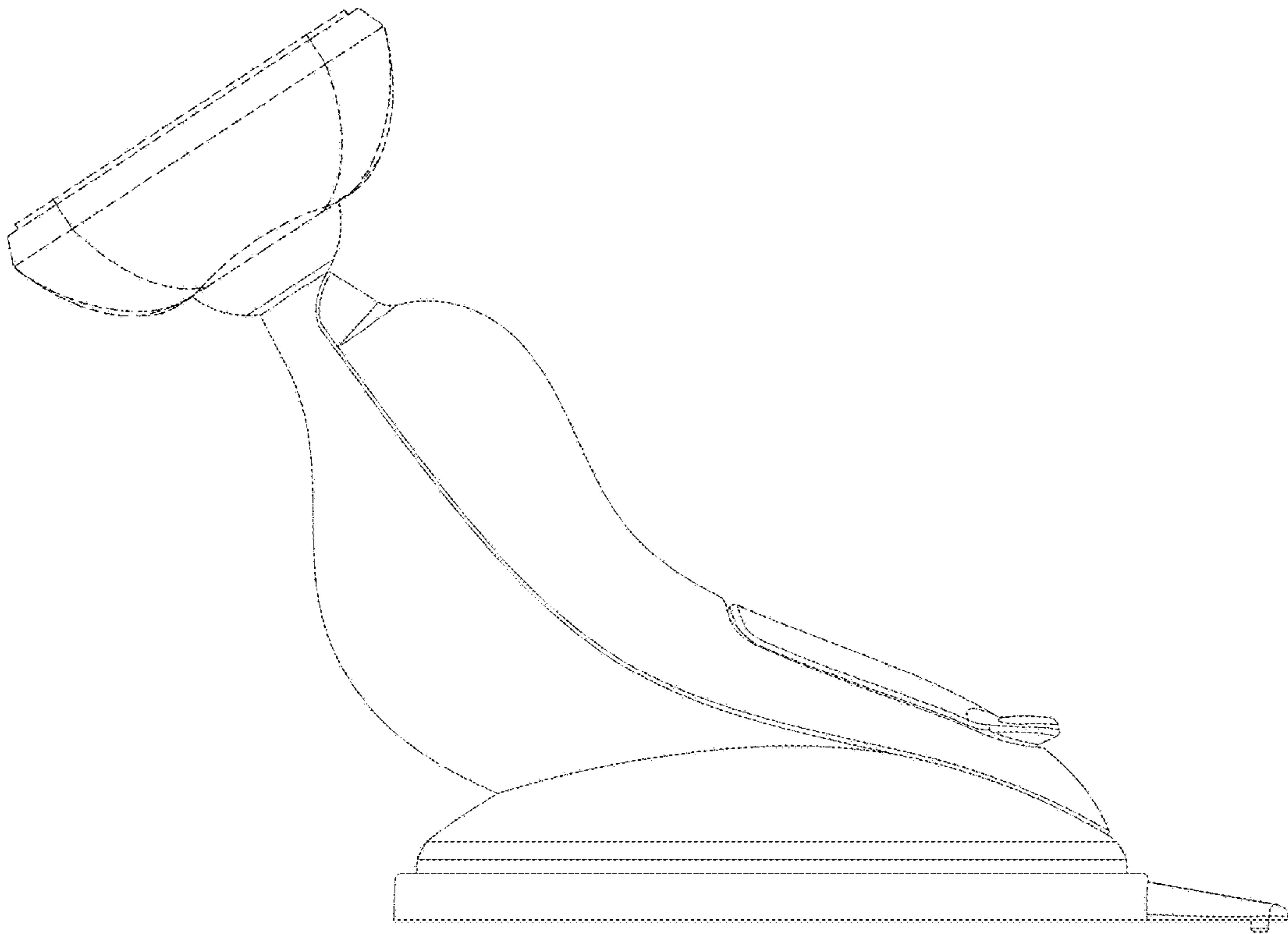

FIG. 2

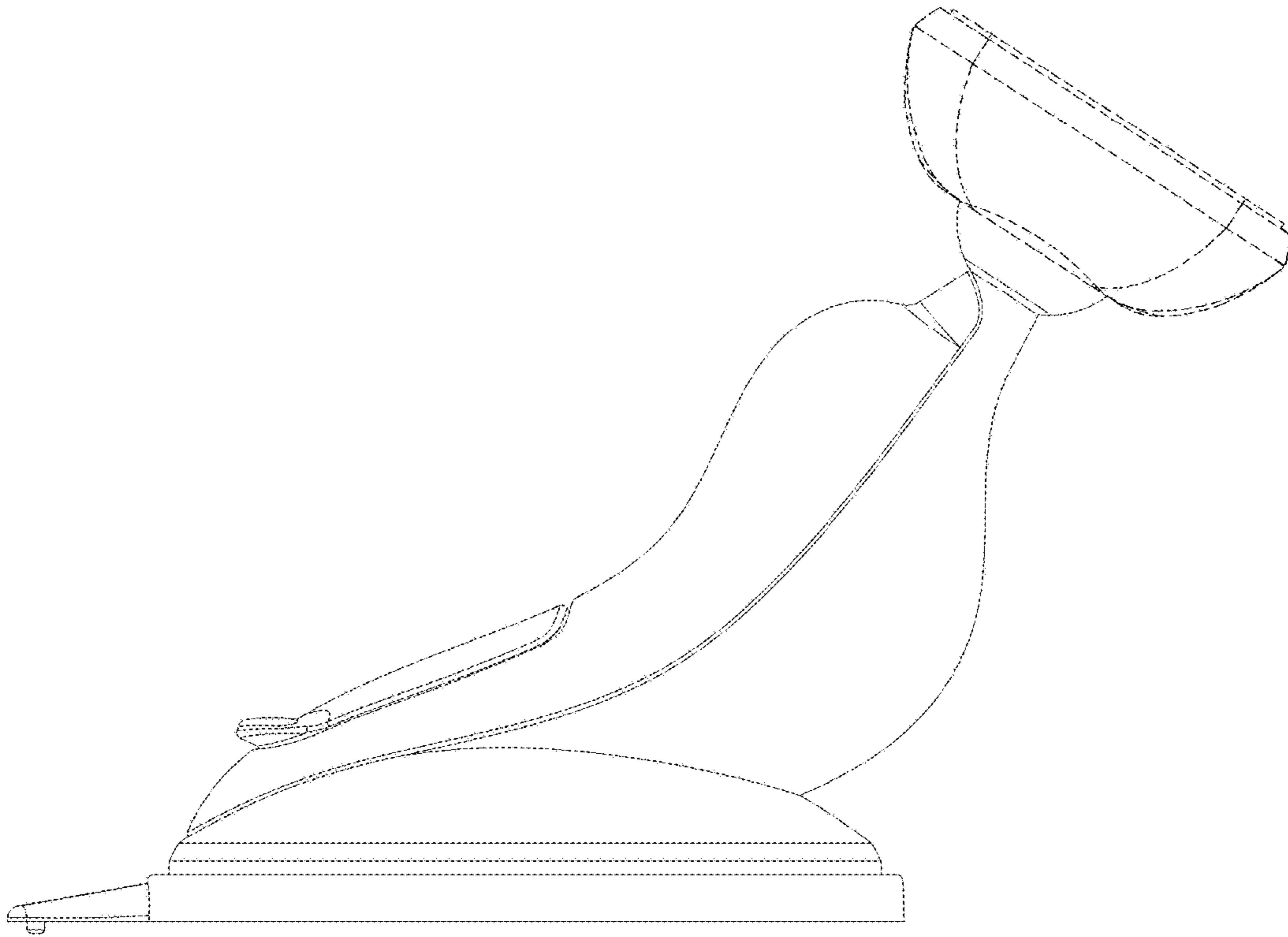

FIG. 3

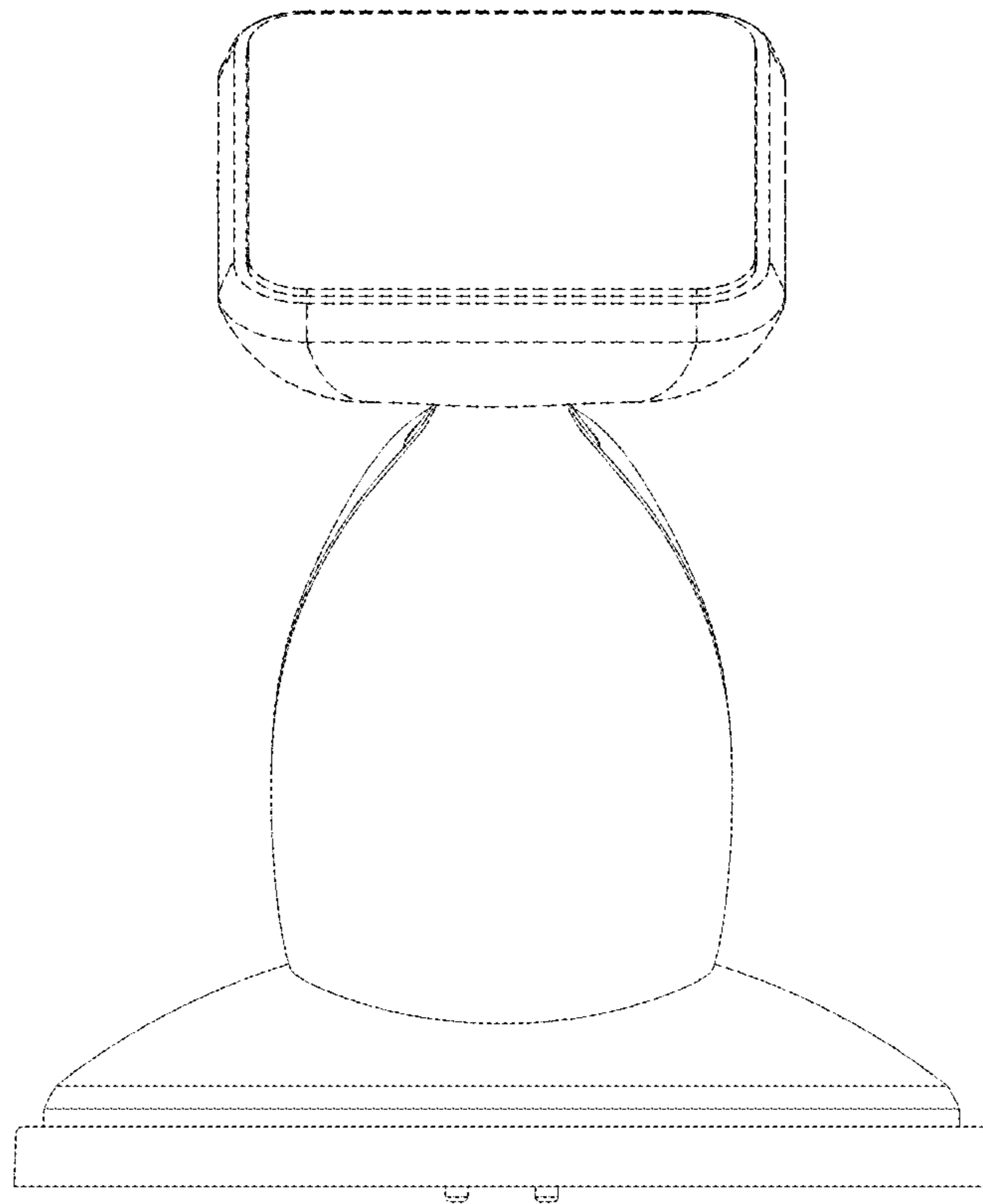

FIG. 4

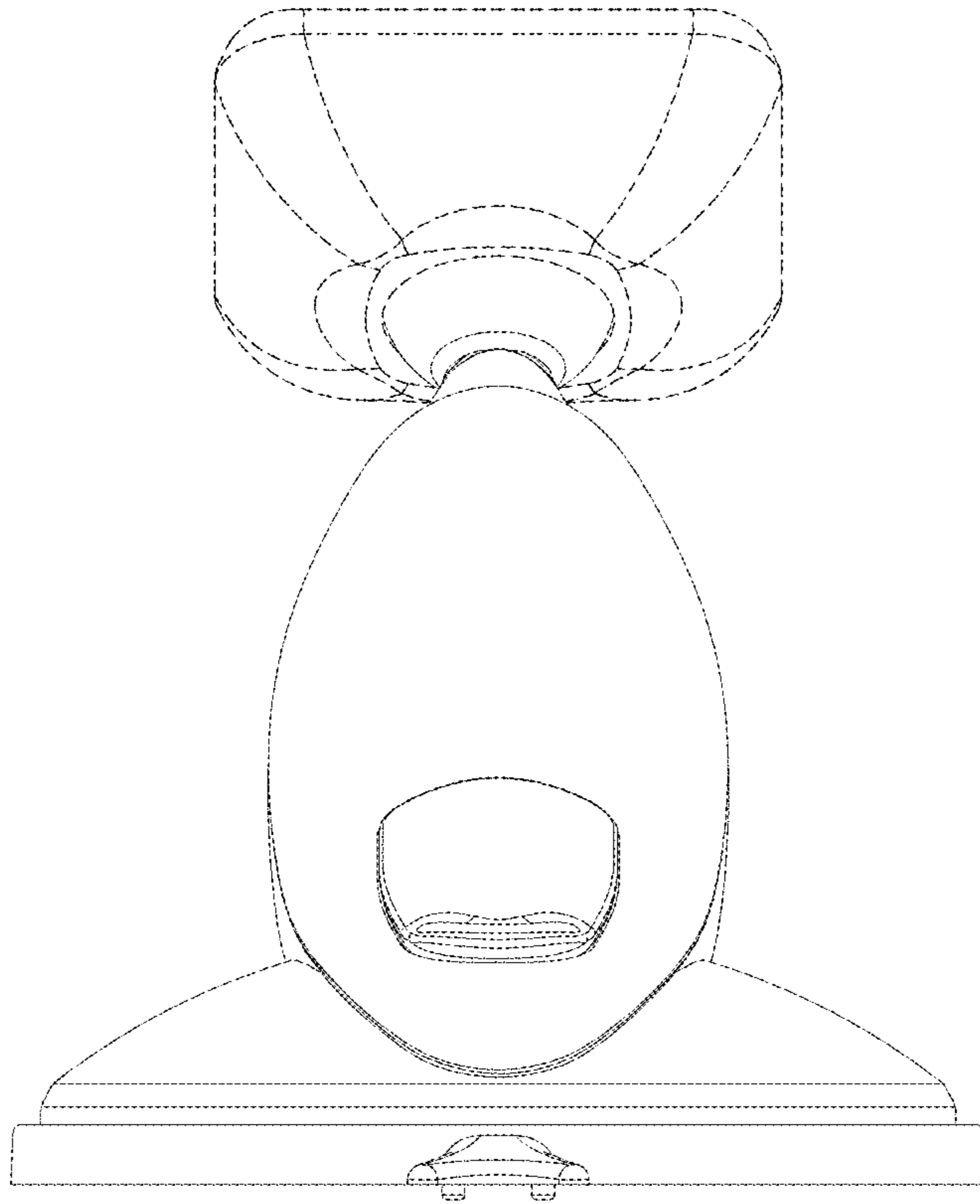

FIG. 5

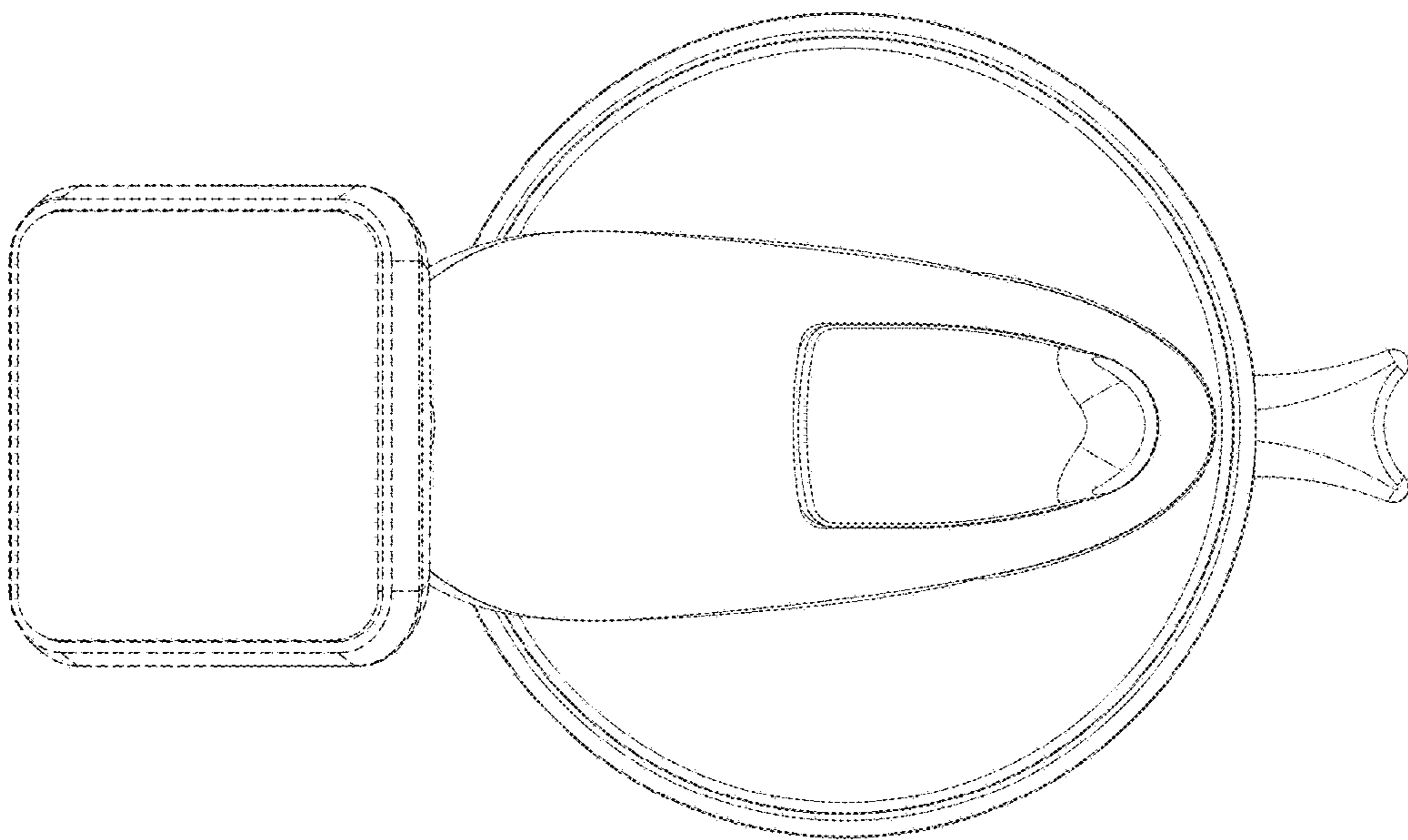

FIG. 6

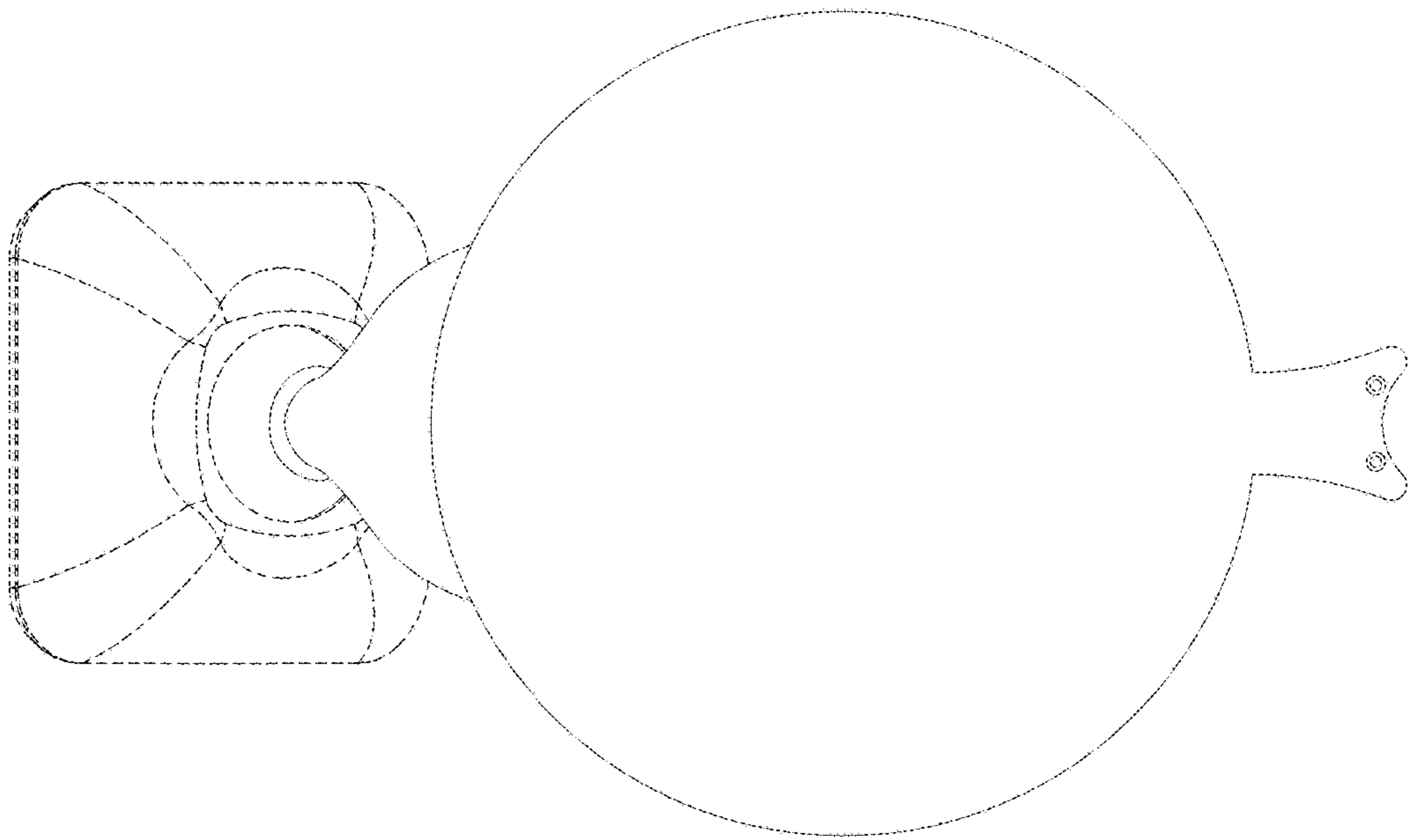

FIG. 7

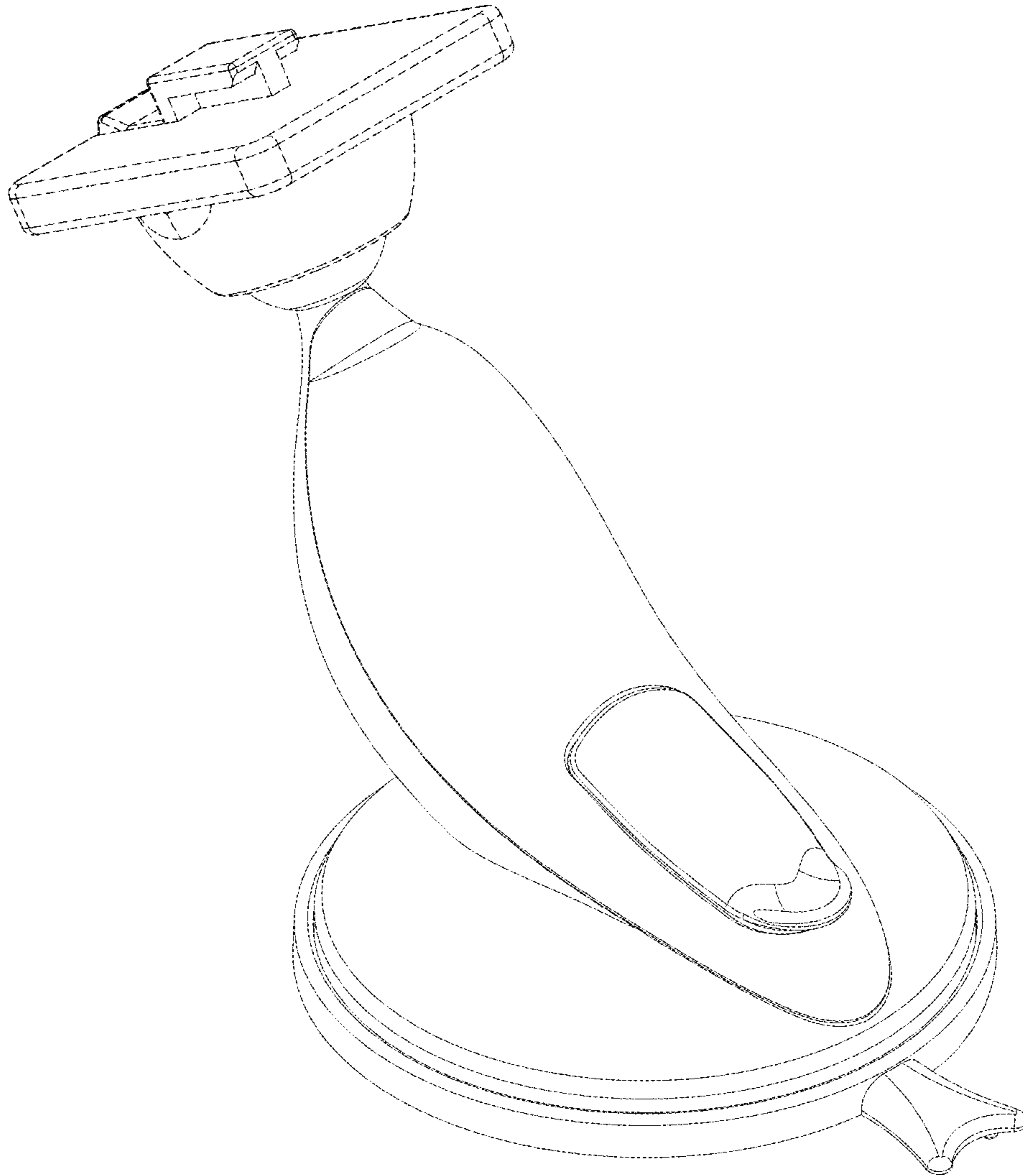

FIG. 8

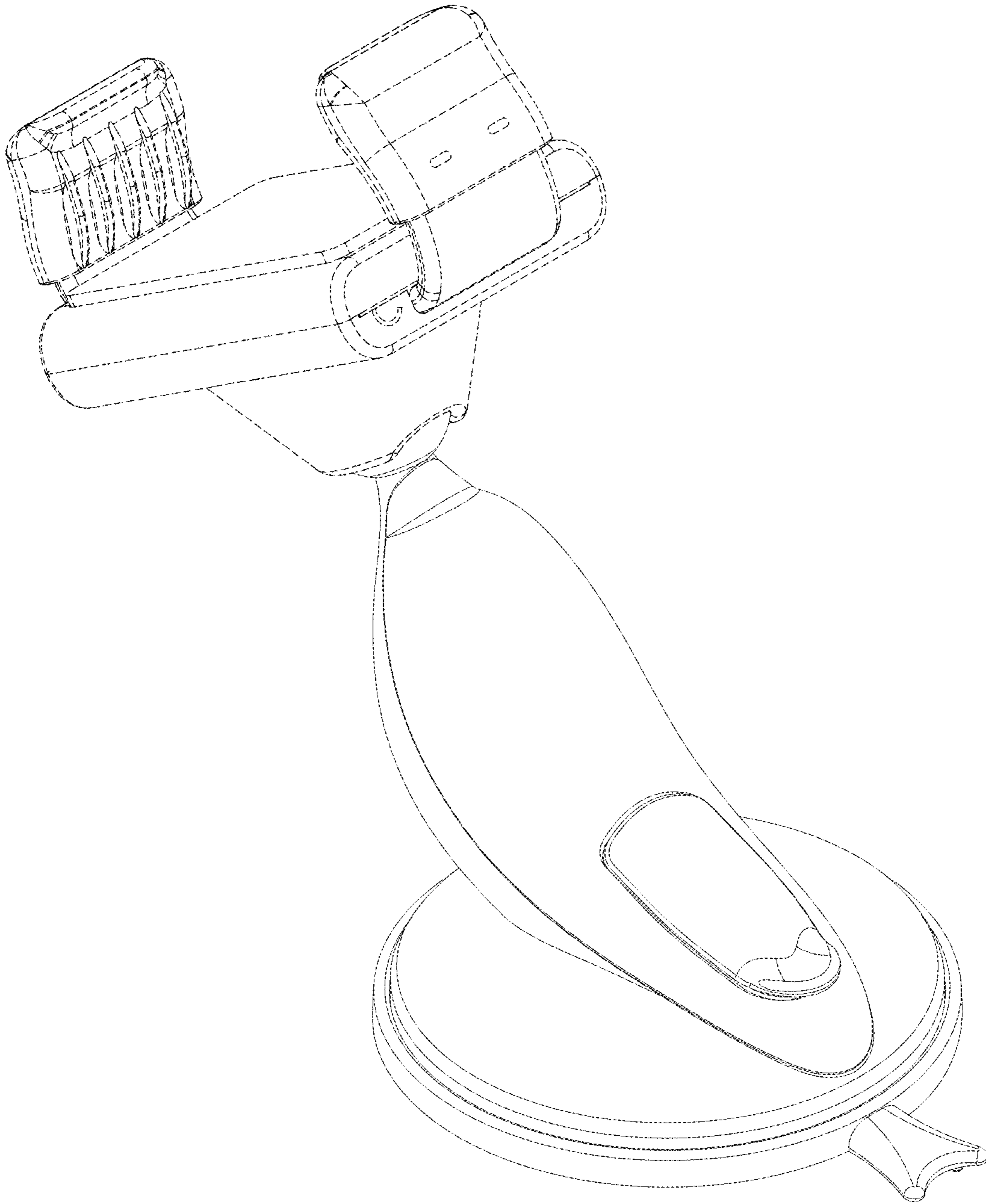

FIG. 9